

100
95
75
25
5
0



100
95
75
25
5
0

Protection of Environment:

"Protection of environment" is one of the core values of Godrej and we seek your co-operation to make sure that the product, packaging and plastic material is not disposed as unsorted municipal waste.



This symbol is known as the "Crossed-out Wheellie Bin Symbol". It means that the product should not be disposed of with your general house-hold waste. It should be disposed of only through the company's collection points with special treatment so as to prevent any damage to the environment. Please call: **1800 209 5511** for applicable buy back arrangement or visit: www.godrejappliances.com/green-think for details about Godrej Appliances authorised collection points.



Godrej & Boyce Mfg. Co. Ltd. - Appliance Division, Plant 11,
Pirojshanagar, Vikhroli (W), Mumbai 400 079.

USER MANUAL
Fully Automatic Top Load

Item code : XXXXXXXXXXXXXXXXXXXX

VO_20012021



**HOW TO GET THE BEST OUT OF YOUR
GODREJ EON WASHING MACHINE**

FULLY AUTOMATIC USER MANUAL

WTEON ALR C 75 5.0 FDANS
WTEON ALR C 75 5.0
WTEON ALR C 75 5.0 FDTH

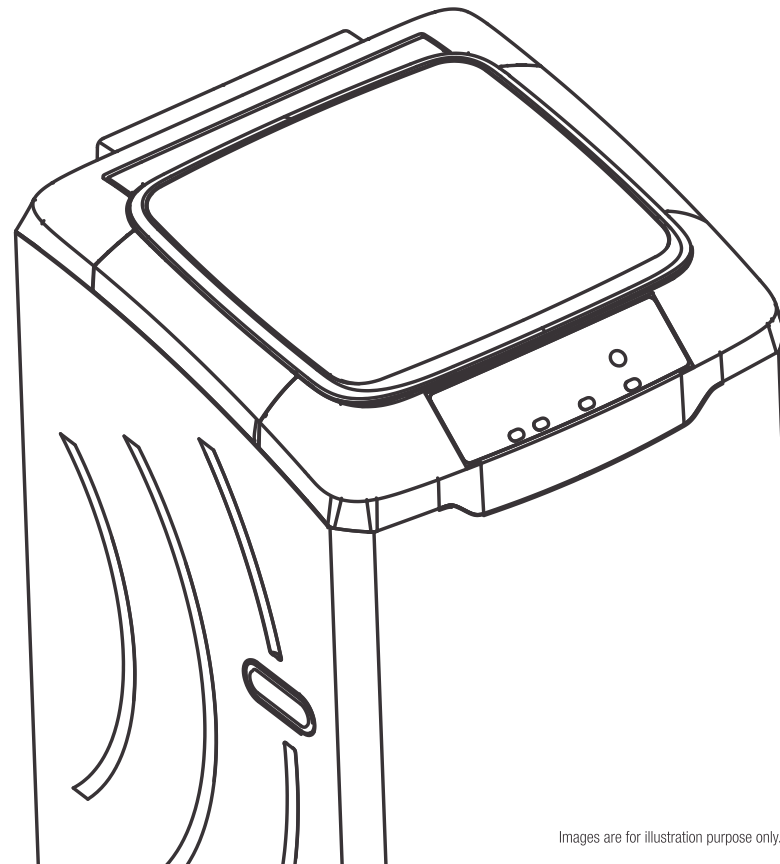

Images are for illustration purpose only.

Cyan Magenta Yellow Black



100
95
75
25
5
0

100
95
75
25
5
0



CONGRATULATIONS

You are now the proud owner of a Godrej washing machine. You can look forward to years of smooth & trouble-free washing from your machine as well as considerable savings in time, money and effort. Please read this manual carefully as it will tell you how to operate your machine optimally in order to get the best results. If you need any further clarifications, do contact your nearest Godrej dealer or any of our service centres/offices. We would be glad to help you. We wish you an easier, more convenient life with your new Godrej washing machine.



Cyan Magenta Yellow Black



Note

Multiple horizontal lines for writing notes.



36





Note

Horizontal lines for note content.

CONTENTS

1.0 INTRODUCTION

- 1.1 Safety Instructions 1
- 1.2 Recommendations 2
- 1.3 Environment Friendly & Energy conservation suggestions 2
- 1.4 Description of Parts & Accessories 3
- 1.5 Specifications 4
- 1.6 Know Your Washing Machine - Product features 5

2.0 INSTALLATION

- 2.1 Choosing the right location 6
- 2.2 Step-by-step installation 6
- 2.3 Ensuring proper earthing 7
- 2.4 Installing the drain hose 9
- 2.5 Installing the rat mesh 9
- 2.6 Attaching the water feed hose to the tap 10
- 2.7 Connecting the water feed hose to your washing machine 11

3.0 BEFORE STARTING TO WASH

- 3.1 Washing tips 12
- 3.2 Adding detergent 12
- 3.3 How to use fabric softener 13
- 3.4 Washing cycles 14
- 3.5 Control panel explanation (Non-Heater Model) 15
- 3.6 Control panel explanation (Heater Model) 17

4.0 WASHING PROGRAM

- 4.1 Program cycles (Non-heater model) 19
- 4.2 Program cycles (Heater model) 21
- 4.2 Types of clothes that can be washed various wash programs 23
- 4.3 How to select water level and load size 23
- 4.4 How to measure wash load 23
- 4.5 How to operate 24

5.0 MAINTENANCE

- 5.1 Cleaning of water inlet 25
- 5.2 Washing machine body 25
- 5.3 Cleaning the magic filter 25
- 5.4 Fuzzy calibration 26

6.0 TROUBLESHOOTING

- 6.1 Troubleshooting 27
- 6.2 Call the service person 29

7.0 SERVICE CENTRES 30

8.0 WARRANTY 31



1.1 Safety Instructions

To protect you and other people's health and property, be sure to observe the following safety instructions

Possible danger of electric shock

- 1) Use socket with rated current of the washing machine. Make sure that electrical connections & earthing are done properly to avoid electrical shocks.
- 2) Do not use extension cords as these may not be properly earthed.
- 3) Hold the plug firmly while plugging in and pulling out. Do not use damaged electrical cord. Use only dry clothes to clean the plug when it is dirty.
- 4) Do not use wet hands to insert or pull out the plug.
- 5) Pull out the plug when the machine operation is completed (or) under repair (or) in the cleaning process.

Possible danger of washing machine damage

- 1) Do not put heavy things on top of the washing machine.
- 2) Remove the power plug before moving the machine.
- 3) Only authorised personnel should repair the washing machine.

Possible danger of explosion

- 1) Do not wash or dry flammable clothes stained with kerosene, gasoline, thinner, etc.
- 2) Do not operate the machine when there is a gas leak.

Possible danger of fire or electricity leak

- 1) Do not keep the washing machine near fire, or put lit cigarettes, candles, and other volatile materials on the machine.
- 2) Do not pour water over the panel.
- 3) Do not put the washing machine in very wet places or near water leakage.
- 4) Check if the drain hose is placed correctly, so that the water drains out smoothly.

Possible danger of body injury

- 1) Packing materials may be dangerous to kids; please keep all the packing materials (plastic bag, foam etc.) away from the kids.
- 2) This machine is not intended for use by people (including kids) with reduced physical, sensory or mental capabilities, or lack of experience and knowledge, unless they are under supervision or instructions concerning the use of the machine by a person responsible for their safety.
- 3) Kids are forbidden to play with the washing machine. Keep pets away from the washing machine.

Possible danger of clothes damage

- 1) Do not wash waterproof clothes, for example: raincoat, feather goods, sleeping bag etc.
- 2) This washing machine is only for home use and is only designed for the textiles suitable for machine washing.

Note

Note

1.2 Recommendations

- 1) Connect machine to a socket having current and voltage rating specified on the power cord plug.
- 2) Use a secure tap connection to avoid leakage and wastage of water.
- 3) Do not use water with temperature over 55 deg. C. This can cause malfunctions and deformation of the machine.
- 4) Do not press control panel pads with sharp objects. Using sharp objects to press the panel pads can result in electrical shocks or malfunctions.
- 5) Do not get the control panel wet. Getting the operation panel wet can result in shocks or malfunctions.
- 6) If the detergent or softener stays in contact with air for a long time, it will dry and stick to the detergent compartment. To avoid this, put the detergent and softener into the detergent compartment just before washing.
- 7) Please do not exceed the maximum loading capacity.
- 8) If you are not going to use the machine for long time, unplug the machine, close the water supply and leave the door open in order to keep the inside of the machine dry and prevent from unpleasant odour.
- 9) The appliance should not be kept on a carpet, which can block the air ventilation at the bottom.
- 10) Do not expose the machine to the direct sunlight.



1.3 Environment & Energy Conservation Suggestions

- After installing the washing machine, recycle/reuse the corrugated box.
- Use the correct quantity of water depending on the quantity of clothes to be washed.
- Use the correct cycle. This helps in saving electricity.
- Fitments and polythene cover/straps: do not dispose them off as garbage. This helps to conserve natural resources and prevents pollution.
- Use less foam making detergent for washing and use the correct quantity of detergent.
- At the end of cycle, please switch off the machine from mains.
- Reuse the soap water if possible. Please follow the instructions for the reuse of soap water.



1.4 Description of Parts & Accessories

Note

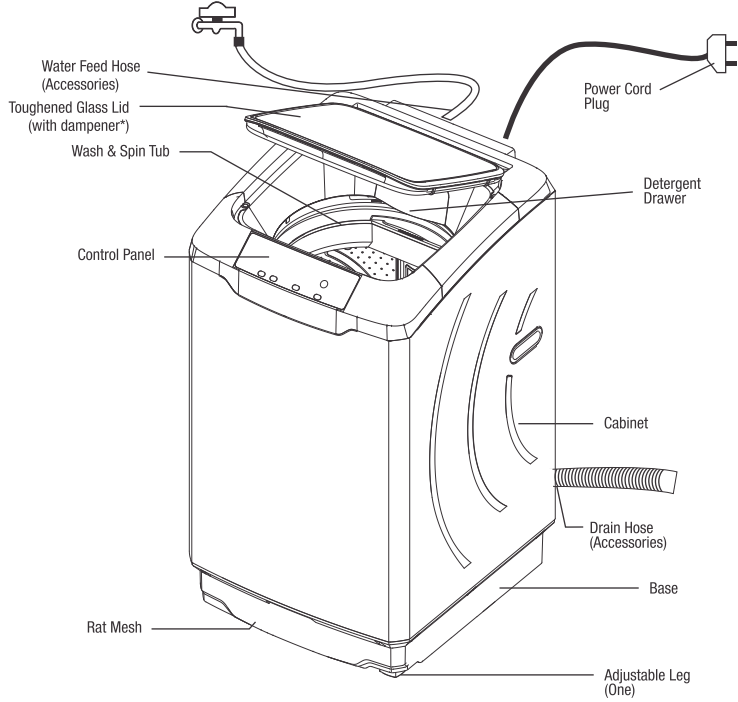



8.0 Warranty

The GODREJ WASHING MACHINE comes with **10 YEARS warranty on wash motor only** and 2 YEARS warranty on all other parts from the date of purchase, against defective material or workmanship. In case of any such defect, Godrej & Boyce Mfg. Co. Ltd. - Appliance Division undertakes to get the appliance repaired free of charge during warranty period, subject to terms and conditions below.

INSTRUCTIONS FOR THE CUSTOMER

- Kindly ensure that the dealer fills the warranty card correctly and completely.
- You should retain the warranty card for record and produce the same in the event of any warranty repairs.
- In the event of a defect developing in the product, contact the nearest authorised Godrej & Boyce Service Centre for obtaining warranty service and provide the defect, Model details & Serial No.
- Product will function between +/- 5% of rated volts. For any fluctuation beyond specified limit, company shall not be responsible. In turn, warranty stands terminated.
- Earthing provision is necessary for the safety of mankind.
- Frequency must be between 5% variation of 50Hz. Beyond this, company shall not be liable for any unforeseen hazards like fire, shock, etc. & in turn, warranty stands terminated.
- Appliance or any part thereof is subjected to neglect, abuse or misuse, tampering, alteration, accident, fire, floods or other acts of God, or damage by rodents or insects, the COMPANY is not responsible for any damage caused to the appliance & shall not be liable for any consequential loss or compensation, nor refund of purchase price or replacement of the appliance.
- In event of repair/replacement of any part/s of the unit, this warranty will thereafter continue and remain in force only for the unexpired period of the warranty. Moreover, the time taken for repair/replacement and in transit whether under the warranty or otherwise shall not be excluded from the warranty period.
- Water supply required above 0.5 bar i.e. 7.25 PSI to operate the Fully Automatic Top Loading washing machine. Without this, company shall not be able to install the product.
- Any damage/defect arising due to entry of coin/foreignparticle into the machine, and causes malfunctioning is not covered under warranty. These calls will be chargeable to customer during warranty period.
- House wiring related issues are not covered under warranty and such calls will be chargeable to customer.
- Calls related to lint filter or water inlet filter cleaning are not covered under warranty and are chargeable to customer.

TERMS AND CONDITIONS

- Repairs and replacement of parts will be carried out through the Authorised Customer Service Centre.
- All transportation and handling expenses incurred while repairing will be payable by the customer.
- For appliances installed beyond the municipal limits of the jurisdiction of the authorised service centre, charges towards technician's visit and other incidentals will be borne by the customer.
- While the company will make every effort to carry out the repairs at the earliest, it however is made expressly clear that the company is under no obligation to do so in a specified period of time.
- The company/its authorised service centre will collect any parts, components replaced.
- Warranty does not cover accessories to the appliance.
- The company's obligation under this warranty shall be limited to repair or providing replacement of part/s only. The maximum claim/s if entertained by the company will be subject to the maximum retail price of the product purchased or purchase price, whichever is lower.
- In the event of any unforeseen circumstances, and spares not being available, the company's prevailing depreciation rules will be binding on the purchaser to accept as a commercial solution in lieu of repairs.
- Warranty is not applicable in case the original number (serial no. sticker) is removed, obliterated or altered from the machine or cabinet.

Godrej & Boyce Mfg. Co. Ltd.- Appliance Division

CUSTOMER COPY

MODEL NO.
UNIT SR. NO.

DATE OF PURCHASE

CUSTOMER'S NAME & ADDRESS

DEALER'S NAME & ADDRESS

TEL. _____

TEL. _____

Customer's Signature:

This warranty is valid only if it is filled in and stamped by our authorised dealer stating the date of purchase.

Warranty Voids If: 1. The warranty card is not completed properly at the time of purchase. 2. The completed warranty card is not presented to the authorised personnel at the time of service of the product. 3. The appliance is not operated according to instructions given in the 'User Guide'. 4. Defects are caused by improper use, which shall be determined by the company's authorised personnel. 5. Unauthorised persons carry out any repair work. 6. Defects are caused by reasons beyond control, like abnormal voltage, acts of God or while in transit to service center or purchaser's residence. 7. The warranty is not valid in case the serial number is deleted, defaced or altered. 8. Damage to the appliance or any parts due to transportation or shifting is not covered by the warranty. 9. The warranty automatically expires after 24 months from the original date of purchase, even if the appliance may not have been in use for any time for whatever reasons during the warranty period.

1.5 Specifications

Model	WTEON ALR C 75 5.0 FDANS WTEON ALR C 75 5.0	WTEON ALR C 75 5.0 FDTH
Capacity (kg)	7.5	7.5
Power source	230V, 50Hz, 5A	230V, 50Hz, 16A
Motor Rating	360W	360W
Heater Rating	Not Applicable	1450W
Water Consumption	180 Ltrs. (Max)	180 Ltrs. (Max)
Water Pressure	0.5-8 kg/cm ²	0.5-8 kg/cm ²
Net dimensions W x D x H (mm)	545 x 620 x 985	545 x 620 x 985
Net weight (kg)	32.8	33.3

In the view of Godrej Policy of continuous development, specifications may change without notice.

SPECIFICATIONS



1.6 Know your Washing Machine - Product Features

The Godrej Eon Allure Classic range of Fully Automatic Top Load Washing Machines has unique features to make your washing very convenient like never before:

1. Fuzzy Logic

- The intelligent micro-controller controls all operations precisely to ensure a perfect wash. The machine is equipped with fuzzy load sensing to determine the water level for the wash load. Washing, rinsing and spin drying happens with a single selection on the control panel.

2. *Heater (in built)

- In built heater provided in the machine enables you to select 60°C Hot wash, program for cleaning cloths in water temperature 60°C .

3. Unbalance Load Corrector

- The Godrej Washing Machine automatically corrects a load unbalance that might occur during the spin cycle. This protects the machine from damages.

4. Rat Mesh

- The rat mesh is provided to protect your machine from damages due to rodent entry.

5. Memory Backup

- During program operation if there is power failure, the machine memorizes the program operation. On restoration of incoming power, the machine will resume from exactly where it was stopped due to power failure for the remaining operation.

6. Child Lock

- This feature allows machine keys to be locked during operation. This prevents unintended changes during wash cycle.

7. Rust Proof Cabinet

- The cabinet of this Godrej washing machine is made from prime quality pre coated galvanised steel to ensure a long life.

8. 9 Wash Programs

For without Heater model:

- The Godrej washing machine provides you the freedom to select 9 wash programs. This includes the REGULAR, DELICATE, HEAVY, QUICKWASH, WASH, RINSE, SPIN, WASH+RINSE, RINSE+SPIN.

For Heater model:

- The Godrej washing machine provides you the freedom to select 9 wash programs. This includes the 60°C HOT WASH, AUTO, DEEP CLEANSE, RAPID 30, WASH, RINSE, SPIN, WASH+RINSE, RINSE+SPIN.

10. Digital Display

- The Godrej washing machine comes with a 2-Digit LED digital display with remaining time indicator. It also indicates the error codes if machine encounters any error.

*Applicable only for selected models.

7.0 Branch Addresses / Service Connect

For any further assistance, please contact our nearest branch office or service centre:

Branch	Branch Addresses	Service Connect
Ahmedabad	4 th Floor, APM Shopping Mall Near IOCL Petrol Pump, Shyamal-Karnavati 100 Ft. Road, Satellite, Ahmedabad - 380 015.	Call 1800-209-5511 (Toll-Free)
Bangalore	3 rd Floor, The Karnataka Film Chamber of Commerce Bldg, 28, 1st Main, Crescent Road, High Grounds Nr. Shivanand Circle, Bangalore - 560 001.	
Bhopal	217, Zone I, M.P. Nagar, Beh. Jyoti Talkies, Bhopal - 462 011.	
Bhubaneswar	Highway Complex NH-5, Rudrapur, Bhubaneswar - 752 101.	
Chandigarh / Mohali	Plot No.A-40, Phase-VIII-A, Industrial Area, Mohali - 160059.	
Chennai	No.1, Sidco Industrial Estate. Ambattur, Chennai - 600 098.	
Coimbatore	585-590, Sathya Towers 3 rd floor, D.B. Road R.S. Puram, Coimbatore - 641 002.	
Delhi	Godrej Bhavan, 2 nd Floor, Shershah Suri Marg, Okhla, New Delhi - 110 065.	
Faridabad	Godrej Bhavan, 2 nd Floor, Shershah Suri Marg, Okhla, New Delhi - 110 065.	
Ghaziabad	Godrej Bhavan, 2 nd Floor, Shershah Suri Marg, Okhla, New Delhi - 110 065.	
Guwahati	Godrej Building, G.S.Road, Ulubari, Flyover, Guwahati - 781 007.	
Hyderabad	201 & 202, Lala-1 Land Mark, 5-4-94 to 97, 2nd Floor, Above Digital Shopyy, Ranigunj, M.G. Road, Secunderabad - 500 003.	
Jaipur	502-506, 5 th Floor, Gaurav Towers, Malviya Nagar, Jaipur-302 017.	
Kochi	2 nd Floor, Angels' Arcade South Kalamassery, Near CUSAT Signal Ernakulam - 682 022.	
Kolkata	Block GN, Sector V, Salt lake, Kolkata - 700 091.	
Lucknow	C 3/3 & C3/4, Sanjay Complex Behind Akashwani Bhawan, Vidhan Sabha Marg Lucknow - 226 001.	
Mumbai	Appliance Divn., Plant 4, Pirojshanagar, Vikhroli, Mumbai - 400 079.	
Nagpur	Dr. Bhiwapurkar Chamber 2nd Floor, Opp: Yashwant Stadium Dhantoli, Nagpur - 440 012.	
Patna	Jeevan Deep Bldg. Exhibition Road, Patna - 800 001.	
Pune	Apollo Building Square, Plot No.60, Survey No.599 Sahaney Sujan Park, Lullanagar, Bibewadi Road, Pune - 411 040.	
Raipur	9/1, Besides Bharat Petrol Pump Opp: Hotel Picadelly, Mahoba Bazaar, GE Road, Raipur - 492 001.	
Ranchi	C/o. Surya Motors, Near Krishi Bazaar Samiti Pandra, Ranchi (Jharkhand) - 835 222.	

Website: www.godrejsmartcare.com & www.godrejappliances.com
E-mail: smartcare@godrej.com SMS: <godrej> <space><care> to 53636



6.2 Call the Service Person

Before you call the service person, please check

- Has your machine's plug been inserted properly into the main power supply socket?
- Is the water tap turned on properly?
- Has the drainage hose been placed down to allow drainage?
- Is the power switch ON?
- Is the lid securely closed? (When beginning operation from the spin cycle, your machine will not operate if the lid is open)
- Is the laundry load unbalanced? If so, correct unbalanced load by manually rearranging the laundry evenly.

When your washing machine leaks, please check

- Is the hose coupling loose?
- Is the water feed hose connector clogged?
- Is the water inlet nut loose?

When your washing machine makes an unusual noise, please check

- Is your washing machine installed on an incline or uneven surface?
- Are there any match sticks, hairpins or metal objects being washed with the laundry?
- Has a foreign object got caught under the pulsator? Switch the power OFF and remove the center screw, then lift the pulsator and look underneath.
- Is the load unbalanced, causing the basket to spin off-center?

When your washing machine does not drain, please check

- Has the WASH-RINSE cycle been selected?
- Is the drainage hose bent?
- Has the drainage hose been placed down to allow proper drainage?
- Is the drainage hose properly connected to your machine?

When the washing cycle takes longer than usual, please check

- Has the automatic load unbalance correction function been activated to correct a load unbalance?
- Is water supply available? Check if the water pressure is low.

2.0 INSTALLATION

2.1 Choosing the right location

- Removal of packaging material
 - Please ensure all packaging / bottom cushion to be removed from the machine before starting machine.
 - CAUTION: Operating the machine with the packaging may cause movement/unbalanced condition and can damage the machine parts.



- Install your Godrej Eon Washing Machine in an even stable place because installing in an unstable location
 - Can create noise as your machine may vibrate
 - Can be dangerous since vibrations may cause the machine to move.

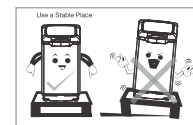

- Keep a distance of at least 5cm between the sides & rear of your machine to the nearest wall.
- This will prevent noise caused by the vibrations in your machine.



- Do not place your machine in an area with high humidity or direct exposure to sunlight or rain.

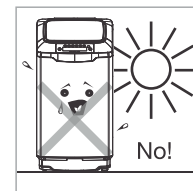

This can

- Result in insulation damage.
- Cause deformation or discoloration of the plastic parts.

2.2 Step-by-step installation

- The front right leg can be adjusted so that the machine is on level with the ground.
- Adjust the leg to the correct height by turning it.
- If the leg height is difficult to adjust because of an extremely uneven floor, place a board underneath & bring it to a level position.
- To check whether your machine is in level, use a weight attached to a string. The distance between the string and your machine should be the same from top to bottom.

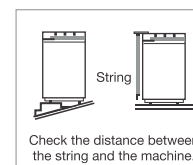
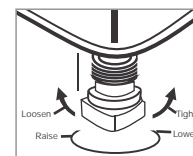

2.3 Ensuring proper earthing

- Your washing machine has three core power cord to power the machine.
- Make sure that electrical and earthing connections are done properly. Live and neutral connections in socket should be as per standard.
- Connect the power cord to Indian Standard 3 pin power socket. Never plug it into an ungrounded power socket.

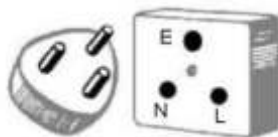

Grounding Method

- Earth wire should be connected. If Earth wire is not connected, there is a potential danger of electric shock caused by current leakage.
- Note that AC power outlet configurations may differ from country to country.
- If the external socket does not have grounding terminal, then a separate grounding is needed.

Other Grounding Methods (any one to be followed)

- Burying copper plate:
Connect the Ground Wire to a Ground Copper Plate and bury it more than 75cm in the ground (by a qualified technician).

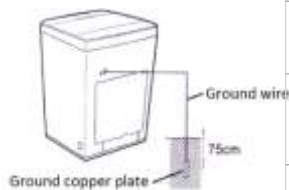

Where to check	How to resolve the problem
<ul style="list-style-type: none"> • Check the power cord is securely plugged in. • Press the Power ON/OFF button. • Press the Start/Pause button. • Check whether power failure has occurred. • Check the main power fuse or circuit breaker has been activated. 	If error persists, Call an authorized technician
<ul style="list-style-type: none"> • Check whether the tap is opened. • Check whether the water supply hose is frozen. • Check Whether is water supply hose or the metal filter in the water inlet is blocked • Check whether the water is out of supply. 	Check and resolve the problem, then open & close the lid to restart the washer.
<ul style="list-style-type: none"> • Check whether the outfall is too high. • Check whether the drain hose is placed correctly. • Check whether the drain hose is blocked by scrap or fibre. • Check whether the drain hose is too long or bend. 	Check and resolve the problem, then open & close the lid to restart the washer.
<ul style="list-style-type: none"> • Check whether the lid is open during spinning 	Close the lid to restart the washer.
<ul style="list-style-type: none"> • Check whether the washing machine is placed steadily. • Check whether the cloth load is appropriate • Check whether the clothes are spread out evenly in the wash basket. 	Balance the clothes evenly and close the lid to restart the washer.
<ul style="list-style-type: none"> • Check the voltage in power socket for proper operating voltage and unplug the machine to avoid further damage or Wait till your input voltage becomes normal 	If error persists, Call an authorized technician
<ul style="list-style-type: none"> • Check the voltage in power socket for proper operating voltage and unplug the machine to avoid further damage or Wait till your input voltage becomes normal 	If error persists, Call an authorized technician
<ul style="list-style-type: none"> • Remove the power plug and put the plug back after one minute. 	If error persists, Call an authorized technician
<ul style="list-style-type: none"> • Remove the power plug and put the plug after 30 min and start machine. 	If error persists, Call an authorized technician
<ul style="list-style-type: none"> • Remove the power plug and put the plug after One minute and start machine. 	If error persists, Call an authorized technician
<ul style="list-style-type: none"> • Remove the power plug and put the plug after One minute and start machine. 	If error persists, Call an authorized technician



6.1 Trouble Shooting

Trouble Indication	Kind of Trouble
No LED glow on Panel or No movement inside Machine	The Washer does not work at all
E1 Error	Water does not flow into wash/ spin tub in 15 min. E1 will be indicated (along with beeps for some time)
E2 Error	If the water does not drain from machine E2 Error will indicate (along with beeps for some time) after 10 minutes of starting drain operation
E3 Error	When the machine is in running condition, if the lid is opened, E3 Error will indicate (along with beeps for some time)
E4 Error	If there is load unbalance for two times, the machine will try to balance it out automatically. If machine goes into unbalance third time, E4 Error will indicate (along with beeps for some time)
EH Error	If input voltage from your socket is very high above 285V, EH Error will indicate (along with beeps)
EL Error	If input voltage from your socket is very low below 160V, EL Error will indicate (along with beeps)
EE Error	Water Level Sensing Error
H9* Error	If the water temperature reaches more than allowable limit of 70°C, by any means, machine will display "H9" error along with the beeps.
H7* Error	If the water temperature is not rising considerably within 45 minutes the machine will display H7 error along with beep.
H8* Error	If heater temperature sensor is not working properly, machine will display "H8" error along with the beeps.

*Applicable only for selected models.

Using a short-circuit breaker:

- If Grounding methods described above are not possible, a separate circuit breaker should be employed and installed by a qualified electrician.

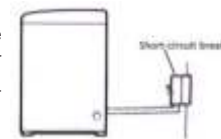
**Never connect ground to:**

- A Gas pipe, Telephone Wire, lightning rod, Neutral, Extension cords without ground terminals, plastic, etc.

Note: All electrical wirings or modifications should be done by a qualified electrician only.

2.4 Installing the drain hose

- Insert the drain hose as far as it will go inside, then secure it tightly with the hose clamp. An improperly secured hose may leak.
- While attaching the drain to a wash pan, leave a gap between the end of the hose and the adjacent surface.
- If the flat end of the hose comes in contact with a flat surface, drain will be affected.

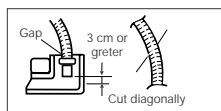
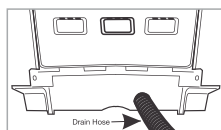

Caution

- If the drain hose is not installed properly, your washing machine may not function well, and the overflow prevention mechanism may cause your machine to stop mid-cycle.
- While inserting the drain hose into a wash pan or drain pipe, move the hook for easier installation.
- Move the hook back to its initial position before placing it in the slot provided on the backside of your machine.
- Make sure the drain hose is not too high else it may get clogged and give error signal.

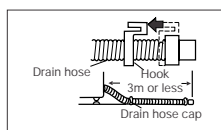
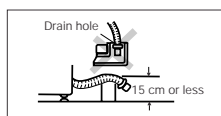

2.5 Installing the Rat Mesh

Tilt the washer on the front side and slide the Rat Mesh as shown in fig.1 and screw it to the base as shown in the fig.2

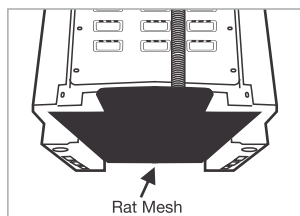

Slide the Rat Mesh into machine base from back side of the machine as shown.

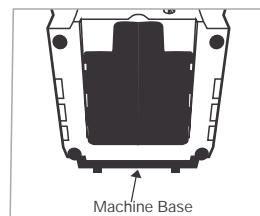

Use 2 nos. screw to fit the Rat Mesh with machine Base as shown.

5.4 Fuzzy Calibration:

- Due to aging, the mechanical friction changes on motor, belt tension and other mechanical parts. Hence it is required to calibrate the machine for fuzzy sensing. Calibration can be done by pressing CYCLE + START / PAUSE + POWER button together for 2sec and machine will automatically perform the calibration.
- Fuzzy Calibration should be started with empty tub, i.e. without water and clothes inside the wash tub.

5.1 Cleaning of Water Inlet

If the water fills into the basket too slowly –

- 1) Stop water supply, unscrew fill hose from the machine.
- 2) Gently pull out the filter.
- 3) Wash the filter thoroughly in running water.
- 4) Fit back filter on the machine and tighten the hose.

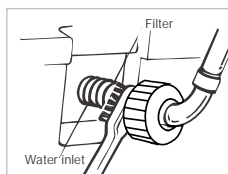

Note - Clean the washer inlet valve filter as and when required.

5.2 Washing Machine Body

- Before carrying out any maintenance on your washing machine, be sure to remove the electrical plug from its power source.
- Clean the main body and control panel with a soft cloth.
- Hard-to-remove dirt can be cleaned by wiping with a soft cloth soaked in a mild detergent.

Caution:

- Do not clean the body or control panel with benzene, thinner, cleanser or other chemical cleaners.
- This can discolour or damage your machine's finish.

5.3 Cleaning the Magic Filter

Clean the lint collector after every use. Follow these steps:

- Remove the lint collector by pulling it out. If it is difficult to lift it out at the place where the machine has stopped, turn the basket by hand to a more convenient place and remove the lint collector.
- Open the cover of the lint collector as shown.
- Clean the filter in running water.
- When the lint collector has been emptied and cleaned, close the front cover and replace the lint collector by inserting it from the bottom and pressing it back into place.

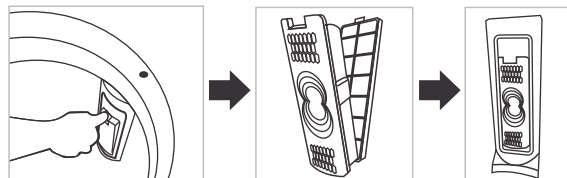

Press the lock to remove the magic filter.

Open the cover and clean the filter in running water.

Close the cover and fit the magic filter as shown.

2.6 Attaching the water feed hose to the tap

- Pull the sleeve down with your fingers as you lower the entries hose to disconnect the union.



- Loosen the four screws on the hose union and then fit the union exactly over the mouth of the tap.
- Tighten the four screws evenly around the tap.

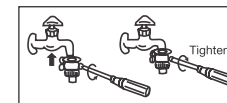

- Remove the seal from the union and turn the nozzle to tighten securely. (If the tap is large, square or oddly shaped, remove the inside ring to facilitate attachment).

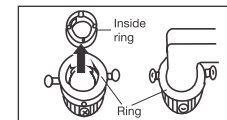
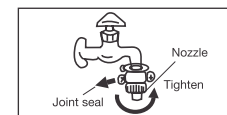

- Grip the ring with your hand and pull it down, and then insert the nozzle. Separate the sleeve until you hear a click, and then push it back.



- After installation, check to ensure that the union does not come off while pulling down.
- Next, confirm that the union is properly installed by turning the water on and checking for leakage.
- If you see any leakage adjust the section where there is a leakage.
- A secure water connection for your automatic washing machine will help you to use the auto start feature.

*The images are for representation purpose only

2.7 Connecting the water supply hose to your washing machine

- Turn the water intake hose nut clockwise and tighten it on the end of the water supply hose securing it to the water intake hose.
- Tighten further by turning the water supply hose and water intake valve in the direction of the arrow as shown.
- Hold the hose nut firmly. Turn the water supply hose back again only in the direction of the arrow as shown.
- Repeat steps 2 and 3 above, and tighten until you find it difficult to turn the water supply hose further.

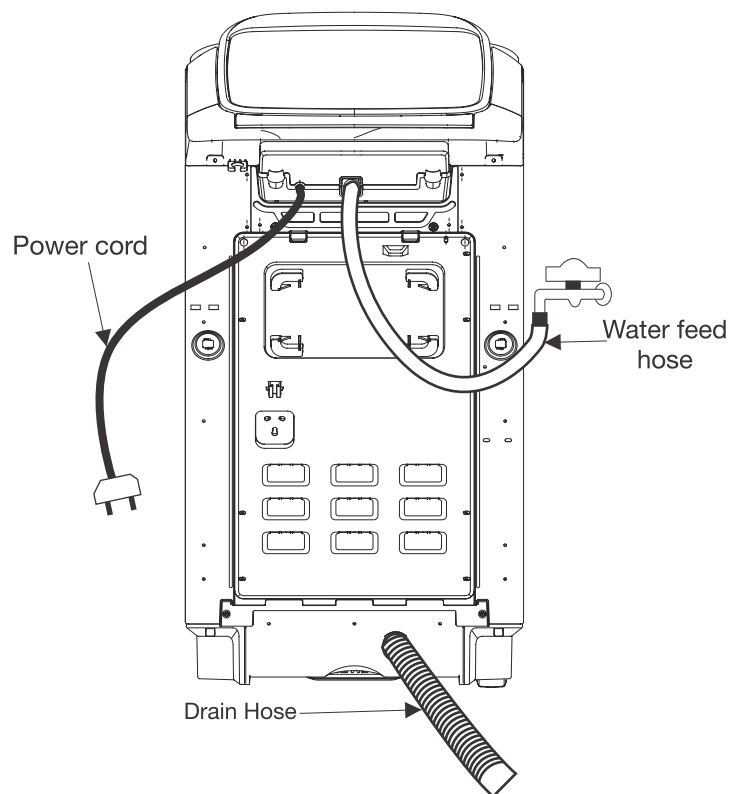
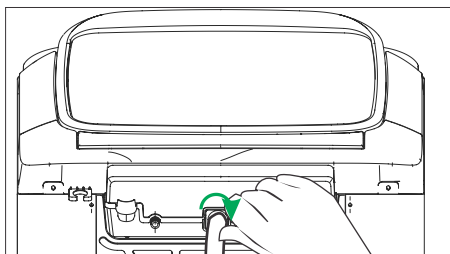

- Open the Lid

4.5 How to operate

- While loading dry clothes, check whether there is anything in the pockets (for example: coin, pins, clips, paper, etc).



When washing using the Regular cycle

Preparation

- Ensure that the electrical plug is properly connected.
- Ensure that the water supply and drainage hoses are correctly installed.

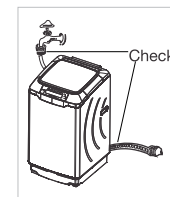

Put detergent in the detergent compartment and laundry in the basket.

Turn the power on

- Close the lid
- Let the lid dropdown automatically to its initial position (Caution: Do not lift down the lid manually else it will damage the function)



Start the cycle

- Press the START/PAUSE pad to start the machine.
- The machine will run through a full cycle, including RINSE and SPIN.

Cycle end

- A buzzer will signal the end of the cycle.
- Turn off the water tap.
- Switch off the main power supply to the machine.



When washing blankets

Types of blankets which can be washed

Material	100 % synthetic fiber
Weight	3 Kg. or less (use regular cycle with load is less than 2 kg)
Size	140 cm x 200 cm or less
Thickness	Single layer

Turn Power ON

- Select HEAVY/Deep Cleanse program with LOW water level selection. Add detergent in detergent Compartment and press Start/Pause button to allow water and detergent to mix for about one minute. After one-minute turn power switch OFF to stop the machine
- Place blanket into basket. Press it in all way to down by hand, ensuring that it is fully immersed in water
- Restart the machine switching ON power button
- After restarting, press PROGRAM key to select HEAVY/Deep Cleanse Program.
- Water level will be selected as per cloth load. To manually change water level, Select water level as per requirement and press start.

Caution:

- Articles be washed. Avoid washing articles made of animal fur, (e.g. cashmere, angora, mohair) or lace-knits etc.
- Articles to be washed should be fully soaked using the type of detergent specified on the garment label.
- Lukewarm water of 30°C is ideal for washing wool knit articles.

4.2 Types of clothes that can be washed in various Wash Programs

Program	
Regular/ Auto	Any type of clothing
Delicates	Vest, undergarment, blouse, handkerchief, sock, silk garments, etc.
Heavy/Deep cleanse	Bed sheet, khaadi fabric, blanket, etc.
Quick wash/ RAPID 30	Vest, Undergarment Blouse, handkerchief, sock, silk garments etc.
60°C Hot wash	All type of clothing. (only for heater model)

4.3 How to select water level and load size

Program		
Water Level Setting	Weight of Clothes	Example of load
High	3.1 - 7.5 kg	3 Trousers, 4 Shirts, 2 Skirts, 2 Nightgowns, 1 Towel, 4 Vests, 2 Sarees, 2 Dhoti, 2 Blouses and 2 Petticoats
Medium	1.51 – 3.0 kg	3 Trousers, 2 Shirts, 2 Skirt, 1 Night gown, 1 Towel, 3 Vests, 1 Saree, 1 Dhoti, 3 Blouses and 1 Petticoat.
Low	0.81 – 1.5 kg	1 Trouser, 1 Shirt, 2 Vests, 1 Night gown, 2 Blouses and 3 Skirt
Min.	0 – 0.8 kg	1 Trouser, 2 Shirts, 2 Vests, 2 Undergarments and 1 Blouse

4.4 How to Measure Wash load

Here are some of the average weights of commonly used clothes, to help you estimate the weight of the load to be washed.

Approximate weight of clothes			
Item of clothing	Weight (in gms.)	Item of clothing	Weight (in gms.)
Double bedsheet	1000	Single bedsheet	500
Bath towel	500	Table cloth	650
Trousers	400	Jeans	600
Shirt	300	Baggies	500
Saree	500	Petticoat	400
Skirt	250	Pyjamas	400
Dhoti	200	Lungi	225
Night gown	250	Blouse	100
Vest	50	Undergarment	50

While deciding the water requirement for the wash load, check the weight of the clothes and volume occupied by them.

3.0 BEFORE STARTING TO WASH

3.1 Washing Tips

- Check whether there is anything in the pockets (for example: coin, pins, clips, paper, etc).
- Zips should be zipped close and buttons or hooks should be fixed. The loose band or ribbon should be bound together.
- Do not wash coloured clothes together.
- Follow the instructions on the garment labels while washing laundry items. Avoid washing of all the natural woolens and delicate knits such as lace knits.
- Turn garments inside out when washing to avoid piling and lint.
- Strings and fasteners of aprons and pillow cases should be fastened or tied.
- If the clothes are too dirty, use a towel or soft brush dipped in detergents to rub the dirty part slightly, in the same direction.
- Then put the clothes into the machine.
- The machine may shake heavily in spin when there are only few clothes or single big and heavy dress.
- Add 2~3 pieces of clothes into the tub to reduce vibrations.

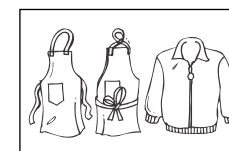
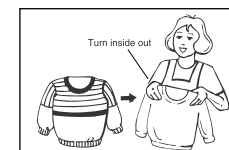

3.2 Adding Detergent

Steps for adding detergent for standard program selection.

- Add dry cloth load in the tub.
- Add detergent as per below table for cloth load.
- Turn ON the machine.

Cloth Weight	Detergent dosage
0 to 0.8 kg	1.0
0.8 to 1.5 kg	1.0
1.5 to 3.0 kg	1.5
Above 3 kg	2.0

3.3 How to Use Softener

When using fabric softener

- Add softener to the softener dispenser located at the top of the basket.
- If the location of the basket makes it difficult to fill dispenser, turn the basket to the right and move it to a more accessible spot.
- Wash as described under washing process.
- For the amount of softener to be used, follow the instructions on the softener label.

Caution:

- Do not open the lid while spinning. It will interfere with the amount of softener dispensed and reduce effectiveness.
- Do not leave the washing machine idle for long periods while filled with softener.

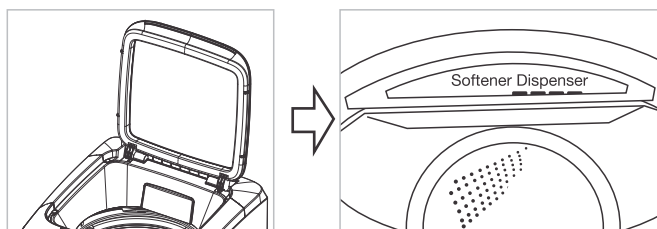

Heater Function (for Heater model)

- Heater function is selected by pressing program key by select program '60°C Hot wash', for cleaning cloths in water temperature 60°C .
- While using this program total cycle time is approx. 2 hours and water temperature is approx. 60°C.

WASH	RINSE 1	RINSE 2	SPIN	*APPROX. TOTAL WASH TIME
~4 min. water in + ~14 min (wash) + ~ 4 min (in built soak)	11-12 min	11-12 min	8 min	55 min
~ 4 min water in + ~ 10 min wash + ~ 8 min (inbuilt soak)	11-12 min	11-12 min	8 min	55 min
~4 min. water in + ~9 min (wash) + ~ 15 min (in built soak)	11-12 min	11-12 min	9 min	61 min
~ 4 min water in + ~ 6 min (wash)	11-12 min	0 min	8 min	30 min

*Approx. Total wash time includes water intake into the machine apart from cycle time.

Energy label declaration program –Deep cleanse –by default water level will be 'High' for energy program. User can change the water levels at any other water level energy rating will not be considered.



4.2 Program cycles (Heater Model)

WASHING PROGRAM	PROCEDURE FOR SETTING WASH CYCLE
60°C Hot wash Program	<ul style="list-style-type: none"> Turn POWER ON Button. (Auto Program gets selected automatically) Press program button to select 60°C Hot wash program. Water level and wash time is automatically selected by the machine. Press Start/Pause button to start the machine.
Auto Program	<ul style="list-style-type: none"> Turn POWER ON Button (Auto Program gets selected automatically) Press Start/Pause button to start the machine. Water level and wash time is automatically selected by the machine, if not selected manually. Press water level button to change the water level if desired. Auto program is set from factory as default program.
Deep Cleanse	<ul style="list-style-type: none"> Turn POWER ON Button (Auto Program gets selected automatically) Press Program button to select Deep Cleanse Program Water level and wash time is automatically selected by the machine if not selected manually. Press water level key to change the water level if desired. Press Start/Pause button to start the machine.
RAPID 30	<ul style="list-style-type: none"> Turn POWER ON Button (Auto Program gets selected automatically) Press Program button to select RAPID 30 Program. Water level and wash time is automatically selected by the machine. Press water level button to change the water level if desired. Press Start/Pause button to start the machine.

In auto and deep cleanse program, inbuilt-soak is added for advanced wash. During in-built soak, machine will remain idle for short duration.

3.4 Washing Cycles

Select Process	Operations	Process Cycle
Wash Only	<ul style="list-style-type: none"> Press the Power ON button. Press Cycle button to select Wash option Press Start/Pause button to start wash only. 	Wash operation and timing will be as per the Program selected (Eg. 22 min for Regular)
Rinse Only	<ul style="list-style-type: none"> Press the Power ON button Press Cycle button till Rinse LED glows Press Start/Pause button to start Rinse only. 	Rinse operation and timing will be as per the Program selected
Wash + Rinse	<ul style="list-style-type: none"> Press the Power ON button. Press Cycle button till Wash & Rinse LEDs glow together. Press Start/Pause button to start Wash+ Rinse. 	Wash & Rinse operation and timing will be as per the Program selected
Spin Only	<ul style="list-style-type: none"> Press the Power ON button Press Cycle button till Spin LED glows Press Start/Pause button to start Spin only. 	Spin operation and timing will be as per the Program selected
Rinse + Spin	<ul style="list-style-type: none"> Press the Power ON button. Press Cycle button till Rinse & Spin LEDs glow together. Press Start/Pause button to start Rinse+ Spin 	Rinse & Spin Operation and timing will be as per the Program selected



3.5 Control Panel Explanation (Non-Heater model)

Program Button:
Used to select wash cycles as per requirement. By default regular cycle selected.

Water Level Button:
Used to select the required water level manually.



Child Lock: Child lock can be activated by pressing WATER LEVEL and PROGRAM buttons simultaneously for 2 seconds. Once child lock is activated, machine will indicate CL on display periodically. During child lock, all the control panel buttons are inactive. Child Lock will be deactivated automatically after completion of wash cycle or Pressing power button on control panel. Child lock can be deactivated by same manner i.e. pressing WATER LEVEL and PROGRAM button again for 2 seconds.

WASH	RINSE 1	RINSE 2	SPIN	*APPROX. TOTAL WASH TIME
~4 min. water in + ~8 min (wash) + ~ 10 min (in built soak)	11-12 min	11-12 min	8 min	54 min
~ 4 min water in + ~ 5 min (wash)	11-12 min	11-12 min	6 min	39 min
~4 min. water in + ~9 min (wash) + ~ 15 min (in built soak)	11-12 min	11-12 min	9 min	61 min
~ 4 min water in + ~ 5 min (wash)	11-12 min	0 min	8 min	29 min

*Approx. Total wash time includes water intake into the machine apart from cycle time.
Energy label declaration program – HEAVY –by default water will be 'High' for energy program. User can change the water level-at any other water levels, energy rating will not be considered.



4.1 Program cycles (Non-heater Model)

WASHING PROGRAM	PROCEDURE FOR SETTING WASH CYCLE
Regular Program	<ul style="list-style-type: none"> • Turn POWER ON Button (Regular Program gets selected automatically) • Press Start/Pause button to start the machine. • Water level and wash time is automatically selected by the machine, if not selected manually. • Regular program is set from factory as default Program
Delicate Program	<ul style="list-style-type: none"> • Turn POWER ON Button (Regular Program gets selected automatically) • Press Program button to select Delicate Program • Water level and wash time is automatically selected by the machine, if not selected manually. • Press water level button to change the water level if desired. • Press Start/Pause button to start the machine.
Heavy Program	<ul style="list-style-type: none"> • Turn POWER ON Button (Regular Program gets selected automatically) • Press Program button to select Heavy Program • Press Start/Hold to start the machine. • Water level and wash time is automatically selected by the machine if not selected manually. • Press water level button to change the water level if desired. • Press Start/Pause button to start the machine.
Quick Wash Program	<ul style="list-style-type: none"> • Turn POWER ON Button (Regular Program gets selected automatically) • Press Program button to select Quick Wash Program. • Water level and wash time is automatically selected by the machine if not selected manually. • Press water level button to change the water level if desired. • Press Start/Pause button to start the machine.

In Regular and Heavy programs, inbuilt-soak is added for advanced wash. During in-built soak, machine will remain idle for short duration.

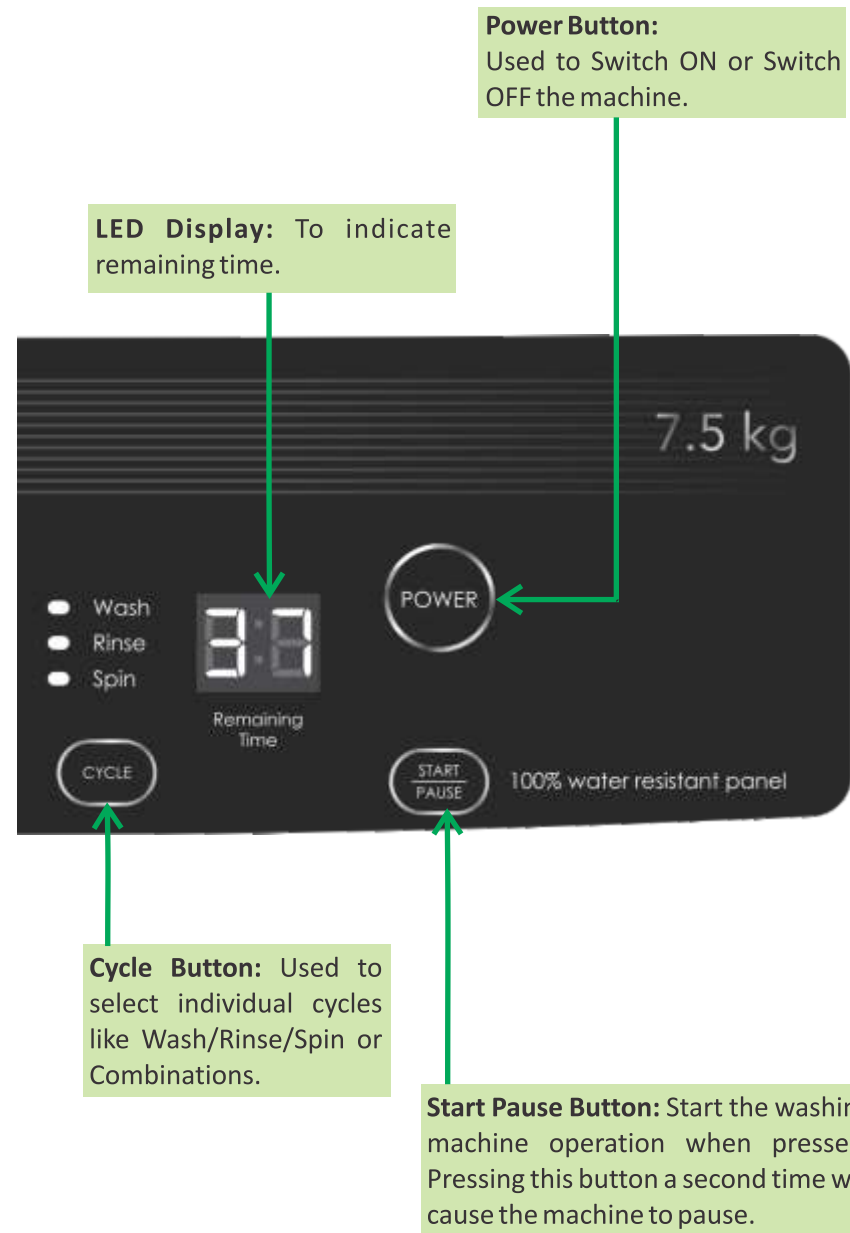

3.6 Control Panel Explanation (Heater model)

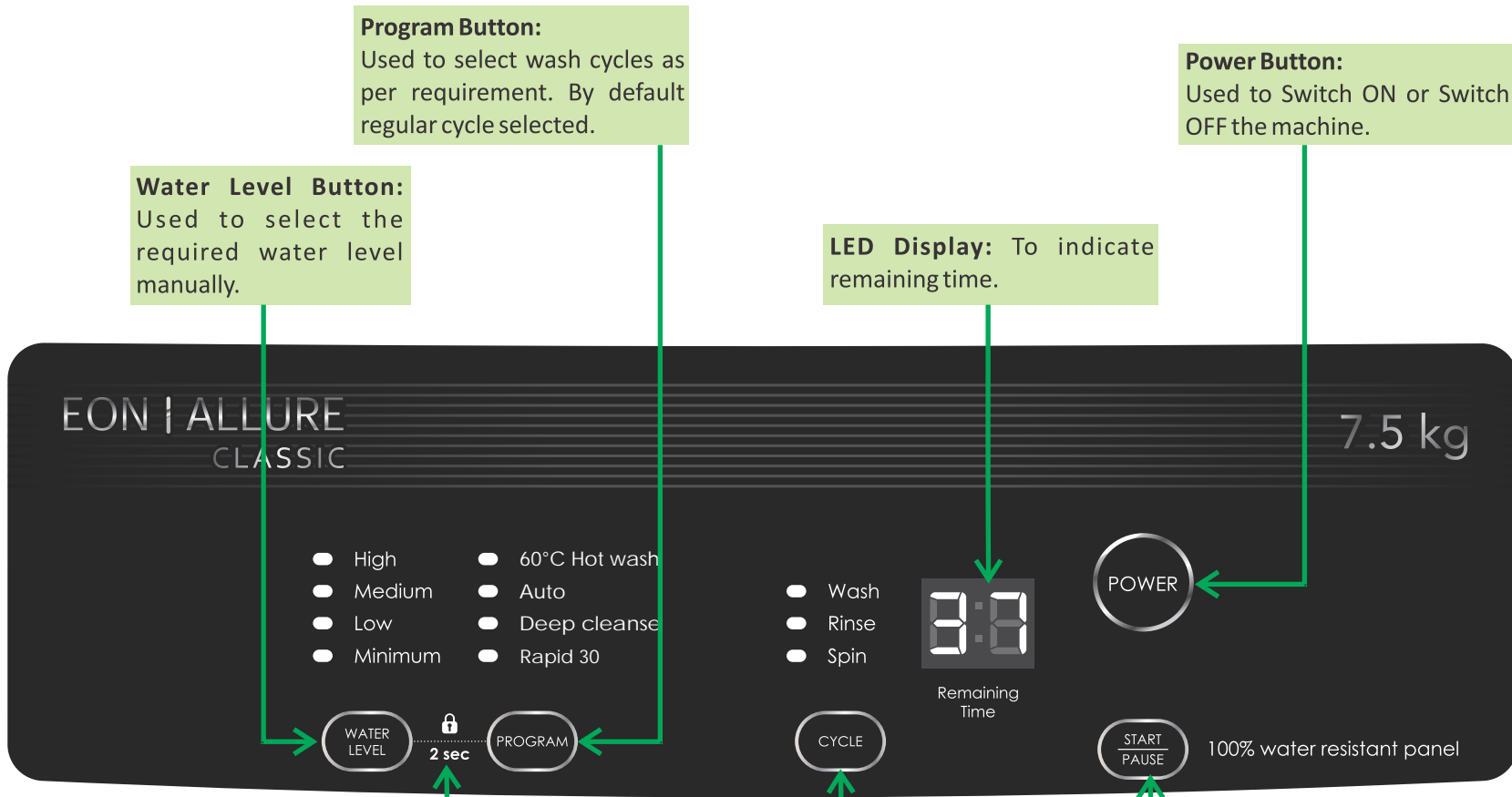

Program Button:
Used to select wash cycles as per requirement. By default regular cycle selected.

Water Level Button:
Used to select the required water level manually.

LED Display: To indicate remaining time.

Power Button:
Used to Switch ON or Switch OFF the machine.

Child Lock: Child lock can be activated by pressing WATER LEVEL and PROGRAM buttons simultaneously for 2 seconds. Once child Lock is activated, machine will indicate CL on display periodically. During child lock, all the control panel buttons are inactive. Child Lock will be deactivated automatically after completion of wash cycle or Pressing power button on control panel. Child lock can be deactivated by same manner i.e. pressing WATER LEVEL and PROGRAM button again for 2 seconds.

Cycle Button: Used to select individual cycles like Wash/Rinse/Spin or Combinations.

Start Pause Button: Start the washing machine operation when pressed. Pressing this button a second time will cause the machine to pause.

