

100  
95  
75  
25  
5  
0

100  
95  
75  
25  
5  
0

USER MANUAL  
Fully Automatic Top Load



# HOW TO GET THE BEST OUT OF YOUR GODREJ EON WASHING MACHINE

FULLY AUTOMATIC USER MANUAL  
**WTEON ALR 75 5.0 FISGS**

**Protection of Environment:**

"Protection of environment" is one of the core values of Godrej and we seek your co-operation to make sure that the product, packaging and plastic material is not disposed as unsorted municipal waste.



This symbol is known as the "Crossed-out Wheelex Bin Symbol". It means that the product should not be disposed of with your general house-hold waste. It should be disposed of only through the company's collection points with special treatment so as to prevent any damage to the environment. Please call: **1800 209 5511** for applicable buy back arrangement or visit: [www.godrejappliances.com/green-think](http://www.godrejappliances.com/green-think) for details about Godrej Appliances authorised collection points.



Godrej & Boyce Mfg. Co. Ltd. - Appliance Division, Plant 11,  
Pirojshanagar, Vikhroli (W), Mumbai 400 079.

v1\_29062020 55101521SD01854

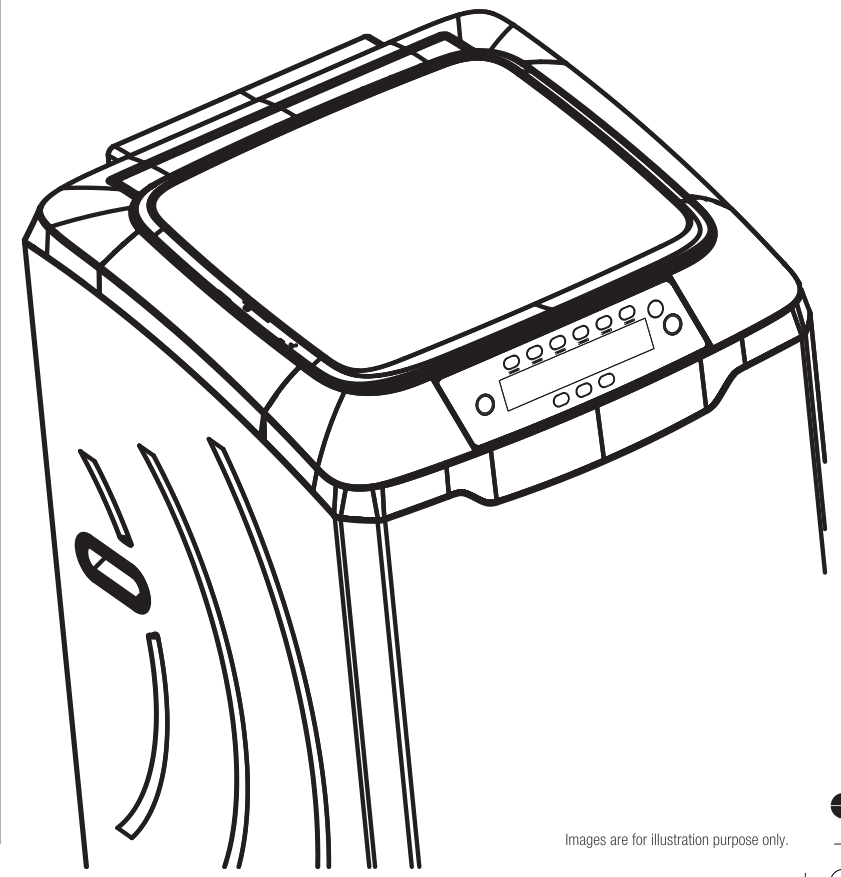

Images are for illustration purpose only.

100  
95  
75  
25  
5  
0

100  
95  
75  
25  
5  
0











## 8.0 Warranty

The GODREJ WASHING MACHINE comes with **10 YEARS warranty on wash motor only** and 2 YEARS warranty on all other parts from the date of purchase, against defective material or workmanship. In case of any such defect, Godrej & Boyce Mfg. Co. Ltd. - Appliance Division undertakes to get the appliance repaired free of charge during warranty period, subject to terms and conditions below.

### INSTRUCTIONS FOR THE CUSTOMER

1. Kindly ensure that the dealer fills the warranty card correctly and completely.
2. You should retain the warranty card for record and produce the same in the event of any warranty repairs.
3. In the event of a defect developing in the product, contact the nearest authorised Godrej & Boyce Service Centre for obtaining warranty service and provide the defect, Model details & Serial No.
4. Product will function between +/- 5% of rated volts. For any fluctuation beyond specified limit, company shall not be responsible. In turn, warranty stands terminated.
5. Earthing provision is necessary for the safety of mankind.
6. Frequency must be between 5% variation of 50Hz. Beyond this, company shall not be liable for any unforeseen hazards like fire, shock, etc. & in turn, warranty stands terminated.
7. Appliance or any part thereof is subjected to neglect, abuse or misuse, tampering, alteration, accident, fire, floods or other acts of God, or damage by rodents or insects, the COMPANY is not responsible for any damage caused to the appliance & shall not be liable for any consequential loss or compensation, nor refund of purchase price or replacement of the appliance.
8. In event of repair/replacement of any part/s of the unit, this warranty will thereafter continue and remain in force only for the unexpired period of the warranty. Moreover, the time taken for repair/replacement and in transit whether under the warranty or otherwise shall not be excluded from the warranty period.
9. Water supply required above 0.5 bar i.e. 7.25 PSI to operate the Fully Automatic Top Loading washing machine. Without this, company shall not be able to install the product.
10. Any damage/defect arising due to entry of coin/foreign particle into the the machine and causes malfunctioning is not covered under warranty. These calls will be chargeable to customer during warranty period.
11. House wiring related issues are not covered under warranty and such calls will be chargeable to customer.
12. Calls related to lint filter or water inlet filter cleaning are not covered under warranty and are chargeable to customer.

### TERMS AND CONDITIONS

1. Repairs and replacement of parts will be carried out through the Authorised Customer Service Centre.
2. All transportation and handling expenses incurred while repairing will be payable by the customer.
3. For appliances installed beyond the municipal limits of the jurisdiction of the authorised service centre, charges towards technician's visit and other incidentals will be borne by the customer.
4. While the company will make every effort to carry out the repairs at the earliest, it however is made expressly clear that the company is under no obligation to do so in a specified period of time.
5. The company/its authorised service centre will collect any parts, components replaced.
6. Warranty does not cover accessories to the appliance.
7. The company's obligation under this warranty shall be limited to repair or providing replacement of part/s only. The maximum claim/s if entertained by the company will be subject to the maximum retail price of the product purchased or purchase price, whichever is lower.
8. In the event of any unforeseen circumstances, and spares not being available, the company's prevailing depreciation rules will be binding on the purchaser to accept as a commercial solution in lieu of repairs.
9. Warranty is not applicable in case the original number (serial no. sticker) is removed, obliterated or altered from the machine or cabinet.

## Godrej & Boyce Mfg. Co. Ltd.- Appliance Division

### CUSTOMER COPY

MODEL NO.  
UNIT SR. NO.

DATE OF PURCHASE

CUSTOMER'S NAME & ADDRESS

DEALER'S NAME & ADDRESS

TEL. \_\_\_\_\_

TEL. \_\_\_\_\_

### Customer's Signature:

**This warranty is valid only if it is filled in and stamped by our authorised dealer stating the date of purchase.**

**Warranty Voids If:** 1. The warranty card is not completed properly at the time of purchase. 2. The completed warranty card is not presented to the authorised personnel at the time of service of the product. 3. The appliance is not operated according to instructions given in the 'User Guide'. 4. Defects are caused by improper use, which shall be determined by the company's authorised personnel. 5. Unauthorised persons carry out any repair work. 6. Defects are caused by reasons beyond control, like abnormal voltage, acts of God or while in transit to service center or purchaser's residence. 7. The warranty is not valid in case the serial number is deleted, defaced or altered. 8. Damage to the appliance or any parts due to transportation or shifting is not covered by the warranty. 9. The warranty automatically expires after 2 years (except wash motor) from the original date of purchase, even if the appliance may not have been in use for any time for whatever reasons during the warranty period.

## 1.2 Recommendations

- 1) Connect machine to a socket having current and voltage rating specified on the power cord plug.
- 2) Use a secure tap connection to avoid leakage and wastage of water.
- 3) Do not use water with temperature over 55 deg. C. This can cause malfunctions and deformation of the machine.
- 4) Do not press control panel pads with sharp objects. Using sharp objects to press the panel pads can result in electrical shocks or malfunctions.
- 5) Do not get the control panel wet. Getting the operation panel wet can result in shocks or malfunctions.
- 6) If the detergent or softener stays in contact with air for a long time, it will dry and stick to the detergent compartment. To avoid this, put the detergent and softener into the detergent compartment just before washing.
- 7) Please do not exceed the maximum loading capacity.
- 8) If you are not going to use the machine for long time, unplug the machine, close the water supply and leave the door open in order to keep the inside of the machine dry and prevent from unpleasant odour.
- 9) The appliance should not be kept on a carpet, which can block the air ventilation at the bottom.
- 10) Do not expose the machine to the direct sunlight.

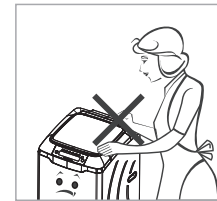

## 1.3 Environment & Energy Conservation Suggestions

- After installing the washing machine, recycle/reuse the corrugated box.
- Use the correct quantity of water depending on the quantity of clothes to be washed.
- Use the correct cycle. This helps in saving electricity.
- Fitments and polythene cover/straps: do not dispose them off as garbage. This helps to conserve natural resources and prevents pollution.
- Use less foam making detergent for washing and use the correct quantity of detergent.
- At the end of cycle, please switch off the machine from mains.
- Reuse the soap water if possible. Please follow the instructions for the reuse of soap water.

### 1.4 Description of Parts & Accessories

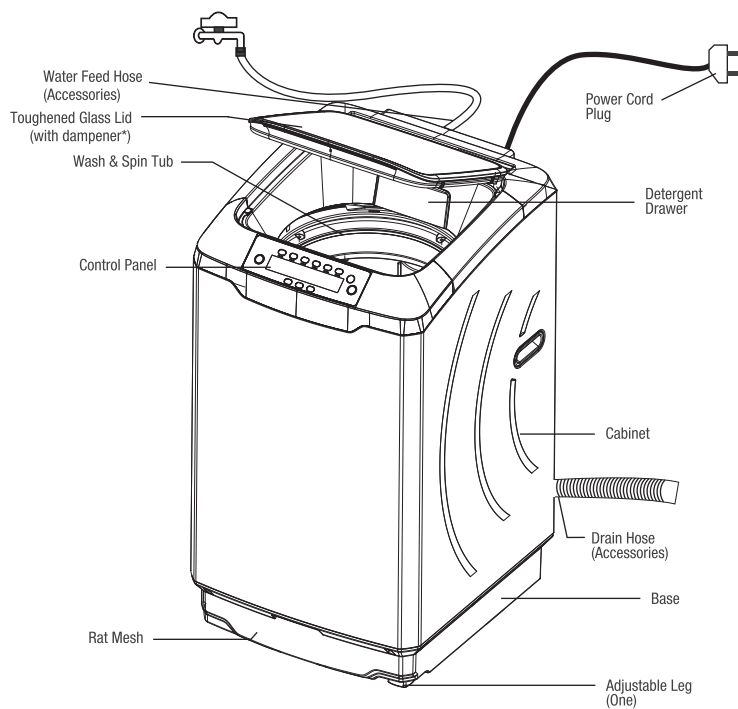

### 7.0 Branch Addresses / Service Connect

For any further assistance, please contact our nearest branch office or service centre:

Branch	Branch Addresses	Service Connect
Ahmedabad	4 <sup>th</sup> Floor, APM Shopping Mall Near IOCL Petrol Pump, Shyamal-Karnavati 100 Ft. Road, Satellite, Ahmedabad - 380 015.	<p>Call 1800-209-5511 (Toll-Free)</p>
Bangalore	3 <sup>rd</sup> Floor, The Karnataka Film Chamber of Commerce Bldg. 28, 1st Main, Crescent Road, High Grounds Nr. Shivanand Circle, Bangalore - 560 001.	
Bhopal	217, Zone I, M.P. Nagar, Beh. Jyoti Talkies, Bhopal - 462 011.	
Bhubaneshwar	Highway Complex NH-5, Rudrapur, Bhubaneshwar - 752 101.	
Chandigarh / Mohali	Plot No.A-40, Phase-VIII-A, Industrial Area, Mohali - 160059.	
Chennai	No.1, Sidco Industrial Estate. Ambattur, Chennai - 600 098.	
Coimbatore	585-590, Sathya Towers 3 <sup>rd</sup> floor, D.B. Road R.S. Puram, Coimbatore - 641 002.	
Delhi	Godrej Bhavan, 2 <sup>nd</sup> Floor, Shershah Suri Marg, Okhla, New Delhi - 110 065.	
Faridabad	Godrej Bhavan, 2 <sup>nd</sup> Floor, Shershah Suri Marg, Okhla, New Delhi - 110 065.	
Ghaziabad	Godrej Bhavan, 2 <sup>nd</sup> Floor, Shershah Suri Marg, Okhla, New Delhi - 110 065.	
Guwahati	Godrej Building, G.S.Road, Ulubari, Flyover, Guwahati - 781 007.	
Hyderabad	201 & 202, Lala-1 Land Mark, 5-4-94 to 97, 2nd Floor, Above Digital Shoppy, Ranigunj, M.G. Road, Secunderabad - 500 003.	
Jaipur	502-506, 5 <sup>th</sup> Floor, Gaurav Towers, Malviya Nagar, Jaipur-302 017.	
Kochi	2 <sup>nd</sup> Floor, Angels' Arcade South Kalamassery, Near CUSAT Signal Ernakulam - 682 022.	
Kolkata	Block GN, Sector V, Salt lake, Kolkata - 700 091.	
Lucknow	C 3/3 & C3/4, Sanjay Complex Behind Akashwani Bhawan, Vidhan Sabha Marg Lucknow - 226 001.	
Mumbai	Appliance Divn., Plant 4, Pirojshanagar, Vikhroli, Mumbai - 400 079.	
Nagpur	Dr. Bhiwapurkar Chamber 2nd Floor, Opp: Yashwant Stadium Dhantoli, Nagpur - 440 012.	
Patna	Jeevan Deep Bldg. Exhibition Road, Patna - 800 001.	
Pune	Apollo Building Square, Plot No.60, Survey No.599 Sahaney Sujan Park, Lullanagar, Bibewadi Road, Pune - 411 040.	
Raipur	9/1, Besides Bharat Petrol Pump Opp: Hotel Picadelly, Mahoba Bazaar, GE Road, Raipur - 492 001.	
Ranchi	C/o. Surya Motors, Near Krishi Bazaar Samiti Pandra, Ranchi (Jharkhand) - 835 222.	

Website: [www.godrejsmartcare.com](http://www.godrejsmartcare.com) & [www.godrejappliances.com](http://www.godrejappliances.com)  
 E-mail: [smartcare@godrej.com](mailto:smartcare@godrej.com) SMS: <godrej> <space><care> to 53636



## 6.2 Call the Service Person

Before you call the service person, please check

- Has your machine's plug been inserted properly into the main power supply socket?
- Is the water tap turned on properly?
- Has the drainage hose been placed down to allow drainage?
- Is the power switch ON?
- Is the lid securely closed? (When beginning operation from the spin cycle, your machine will not operate if the lid is open)
- Is the laundry load unbalanced? If so, correct unbalanced load by manually rearranging the laundry evenly.

When your washing machine leaks, please check

- Is the hose coupling loose?
- Is the water feed hose connector clogged?
- Is the water inlet nut loose?

When your washing machine makes an unusual noise, please check

- Is your washing machine installed on an incline or uneven surface?
- Are there any match sticks, hairpins or metal objects being washed with the laundry?
- Has a foreign object got caught under the pulsator? Switch the power OFF and remove the centre screw, then lift the pulsator and look underneath.
- Is the load unbalanced, causing the basket to spin off-centre?

When your washing machine does not drain, please check

- Has the WASH-RINSE cycle been selected?
- Is the drainage hose bent?
- Has the drainage hose been placed down to allow proper drainage?
- Is the drainage hose properly connected to your machine?

When the washing cycle takes longer than usual, please check

- Has the automatic load unbalance correction function been activated to correct a load unbalance?
- Is water supply available? Check if the water pressure is low.

## SPECIFICATIONS

## 1.5 Specifications

Model	WTEON ALR 75 5.0 FISGS
Capacity (kg)	7.5 kg
Temp. Options	Normal, Warm & Hot
Power source	230V, 50Hz, 16A
Motor Rating	360W
Heater Rating	1450W
Water Consumption	180 Ltrs. (Max)
Water Pressure	0.5-8 kg/cm <sup>2</sup>
Net dimensions W x D x H (mm)	545 x 620 x 985
Net weight (kg)	33.3

In the view of Godrej Policy of continuous development, specifications may change without notice.

## 1.6 Know your Washing Machine - Product Features

The Godrej Eon Allure range of Fully Automatic Top Load Washing Machines has unique features to make your washing very convenient like never before:

### 1. Start After

- One can set a delay for starting program operation using this function so that washing can take place even in one's absence.

### 2. Tub Clean

- This special feature cleans the spin basket & outer tub to prevent stains on cloths as well as unpleasant odor from the machine.

### 3. Child Lock

- This feature allows machine keys to be locked during operation. This prevents unintended changes during a wash cycle.

### 4. Imbalance Load Corrector

- The Godrej washing machine automatically corrects a load imbalance that might occur during the spin Cycle.
- This protects the machine from damages.

### 5. Rat Mesh

- The rat mesh is provided to protect your machine from rodents.

### 6. Cabinet

- The cabinet of this Godrej washing machine is made from prime quality precoated galvanised steel to ensure a long life.

### 7. Cloth load Indication

- The feature indicates weight of loaded clothes helping you to manage laundry better and achieve optimum wash performance.

### 8. Heater (In Built)\*

- In built heater provided in the machine enables you to set the water temperature for cleaning extra soiled clothes, toddler garments washing.

### 9. Germ Shield:

- Heats water up to 60 degrees centigrade – thereby killing 99.99% of germs and 99.99% of allergens

### 10. Eco Mode:

- By selecting this mode, you will be able to smartly wash clothes with saving in water consumption.

### 11. Detergent indicator

- Indicated Number of standard detergent scoops (Approximately 35 gm per scoop) needed for clothes put inside the basket.

\*Applicable only for selected models

Where to check	How to resolve the problem
<ul style="list-style-type: none"> <li>• Check the power cord is securely plugged in.</li> <li>• Press the Power ON/OFF button.</li> <li>• Press the Start/Pause button.</li> <li>• Check whether power failure has occurred.</li> <li>• Check the main power fuse or circuit breaker has been activated.</li> </ul>	Switch off the machine. Please Call service personnel.
<ul style="list-style-type: none"> <li>• Check the voltage in power socket for proper operating voltage and unplug the machine to avoid further damage</li> </ul>	Wait till your input voltage becomes normal
<ul style="list-style-type: none"> <li>• Check whether the tap is opened.</li> <li>• Check whether the water supply hose is frozen.</li> <li>• Check whether the water supply hose or the metal filter in the water inlet is blocked.</li> <li>• Check whether the water is out of supply.</li> </ul>	Check and resolve the problem, then open & close the lid to restart the washer.
<ul style="list-style-type: none"> <li>• Check whether the outfall is too high.</li> <li>• Check whether the drain hose is placed correctly.</li> <li>• Check whether the drain hose is blocked by scrap or fiber.</li> <li>• Check whether the drain hose is too long or bend.</li> </ul>	Check and resolve the problem, then open & close the lid to restart the washer.
<ul style="list-style-type: none"> <li>• Check whether the lid is open during operations.</li> </ul>	Close the lid to restart the operations.
<ul style="list-style-type: none"> <li>• Check whether the washing machine is placed steadily.</li> <li>• Check whether the cloth load is appropriate.</li> <li>• Check whether the clothes are spread out evenly in the wash basket.</li> </ul>	Balance the clothes evenly and close the lid to restart the washer.
	Switch off the machine. Please call service personnel.
	Switch off the machine and remove the power plug from mains. Please Call service personnel.
	Open & close the lid to reset the error. If the error comes again you can repeat the forementioned procedure or switch off the machine, remove the plug & call service personnel
	Switch off the machine and remove the power plug from mains. Please call service personnel.



## 6.1 Trouble Shooting

Trouble Indication	Kind of Trouble
-	Washing Machine does not work at all.
High-Low Voltage	Input voltage at your socket is not in the range of 160V-280V, machine will display "High-Low Voltage" error along with beeps.
No Water	Water does not flow into wash/spin tub in 15 min. machine will display "No Water" error along with beeps.
No Drain	If the water does not drain from machine the display will show "No Drain" error along with the beeps after 10minutes of starting the drain operation.
Lid open	During operation if the lid is open machine will display "Lid Open" error along with the beeps.
Imbalance	If there is load unbalance for two times, the machine will try to balance it out automatically. If machine goes into unbalance third time "Imbalance" error will be displayed along with beeps.
EE	Water Pressure sensor not working properly during operation the machine will give error "EE" with beeps.
H9*	If water temperature reaches more than allowable limit of 60 deg. C, by any means, machine will display "H9" error along with the beeps.
H7*	if the water temperature is not rising considerably within 45 minutes the machine will display H7 error along with beep.
H8*	If Heater temperature sensor is not working properly, machine will display "H8" error along with the beeps.

\*Applicable only for selected models.

## 2.1 Choosing the right location

- Removal of packaging materials
  - Please ensure all packaging / bottom cushion to be removed from the machine before starting machine.
  - CAUTION: Operating the machine with the packaging may cause movement/unbalanced condition and can damage the machine parts.
- Install your Godrej EON Washing Machine on a flat and firm surface.
  - Max tilt angle on the supporting face : 1°.
  - Installing machine on an unstable location can create noise as machine may vibrate.
  - This can be dangerous since vibrations may cause the machine to move.
- Keep a distance of at least 10cm between the sides and rear of your machine to the nearest wall.

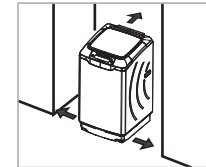
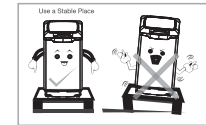
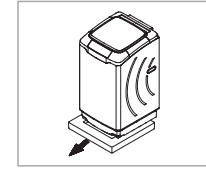

- Do not place your machine in an area with high humidity or direct exposure to sunlight or rain.

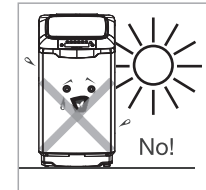

- This can
  - Result in insulation damage
  - Cause deformation or discoloration of the plastic parts.

## 2.2 Step-by-step installation

- The front right leg can be adjusted so that the machine is on level with the ground.
- Adjust the leg to the correct height by turning it.
- If the leg height is difficult to adjust because of an extremely uneven floor, place a board underneath & bring it to a level position.
- To check whether your machine is in level open the lid of machine, pour water into the tub up to the level just above pulsator and check if the water level matches with steel drum holes along the periphery.
- Trolley is not recommended.
- If a trolley is used it should be a metallic trolley with four adjustable legs and with proper locking.

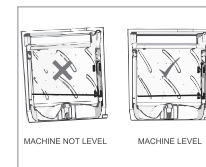
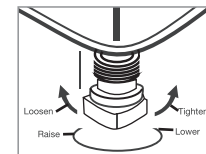

### 2.3 Ensuring proper earthing

- Your washing machine has three core power cord to connect the machine to power line.
- Make sure that electrical and earthing connections are done properly in the wall socket. Live and neutral connections in socket should be as per standard.
- Connect the power cord to Indian Standard 3 pin power socket. Never plug it into an ungrounded power socket.

#### Grounding Method

- Earth wire must be connected in the wall socket. If the earth wire is not connected then there is potential hazard of electric shock caused by the current leakage.
- Note that AC power outlet configurations may differ from country to country.
- If the external socket does not have grounding terminal, then a separate grounding is needed.

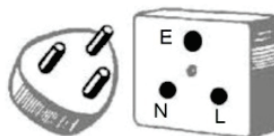

#### Other Grounding Methods (any one to be followed)

- **Burying copper plate:**

Connect the Ground Wire to a Ground Copper Plate and bury it more than 75cm in the ground (by a qualified engineer).

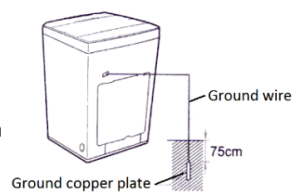

### 5.4 Fuzzy Calibration:

- Due to aging, the mechanical friction changes on motor, belt tension and other mechanical parts. Hence it is required to calibrate the machine for fuzzy sensing.
- Fuzzy Calibration should be started with empty tub, i.e. without water and clothes inside the wash tub.
- Calibration can be done using following steps:
  1. Turn ON the machine from mains.
  2. Press Start/Pause, Customization & Power ON/OFF keys simultaneously for 3 sec.  
The Machine will automatically perform calibration.



### 5.1 Cleaning of Water Inlet

If the water fills into the basket too slowly –

- 1) Stop water supply, unscrew fill hose from the machine.
- 2) Gently pull out the filter.
- 3) Wash the filter thoroughly in running water.
- 4) Fit back filter on the machine and tighten the hose.

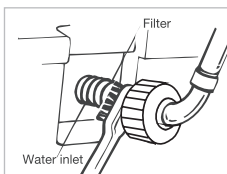

Note - Clean the washer inlet valve filter as and when required.

### 5.2 Washing Machine Body

- Before carrying out any maintenance on your washing machine, be sure to remove the electrical plug from its power source.
- Clean the main body and control panel with a soft cloth.
- Hard-to-remove dirt can be cleaned by wiping with a soft cloth soaked in a mild detergent.

Caution:

- Do not clean the body or control panel with benzene, thinner, cleanser or other chemical cleaners.
- This can discolour or damage your machine's finish.

### 5.3 Cleaning the Magic Filter

Clean the lint collector after every use. Follow these steps:

- Remove the lint collector by pulling it out. If it is difficult to lift it out at the place where the machine has stopped, turn the basket by hand to a more convenient place and remove the lint collector.
- Open the cover of the lint collector as shown.
- Clean the filter in running water.
- When the lint collector has been emptied and cleaned, close the front cover and replace the lint collector by inserting it from the bottom and pressing it back into place.

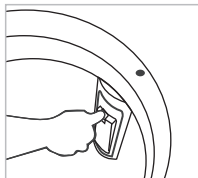

Press the lock to remove the magic filter.

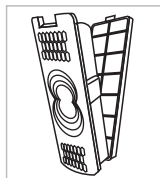

Open the cover and clean the filter in running water.

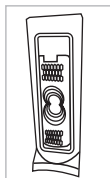

Close the cover and fit the magic filter as shown.

### Using a short-circuit breaker:

- If Grounding methods described above are not possible, a separate circuit breaker should be employed and installed by a qualified engineer.

### Never connect ground to:

- A Gas pipe, Telephone Wire, lightning rod, Neutral, Extension cords without ground terminals, plastic, etc.

Note: All electrical wirings or modifications should be done by a qualified engineer only.

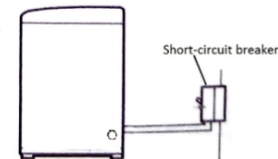

\* Above images are for representation purpose only

## 2.4 Installing the drain hose

- Insert the drain hose as far as it will go inside, then secure it tightly with the hose clamp. An improperly secured hose may leak.
- While attaching the drain hose to a wash pan, leave a gap between the end of the hose and the adjacent surface.
- If the flat end of the hose comes in contact with a flat surface, drain will be affected.

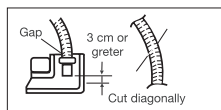
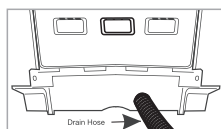

### Caution

- If the drain hose is not installed properly, your washing machine may not function well, and the overflow prevention mechanism may cause your machine to stop mid-cycle.
- While inserting the drain hose into a wash pan or drain pipe, move the hook for easier installation.
- Move the hook back to its initial position before placing it in the slot provided on the backside of your machine.
- Make sure the drain hose is not too high else it may get clogged and give error signal.

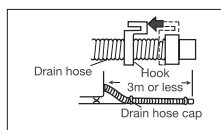
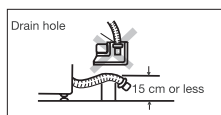

## 4.6 How to operate

- Check whether there is anything in the pockets (for example: coin, pins, clips, paper, etc).

### When washing using the DAILY cycle Preparation

- Ensure that the electrical plug is properly connected.
- Ensure that the water supply and drainage hoses are correctly installed.

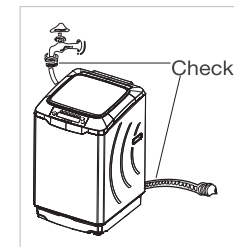

Put detergent in the detergent compartment and laundry in the basket.

### Turn the power on

- Close the lid and turn the POWER switch ON.

### Start the cycle

- Press the START/PAUSE pad to start the machine.
- The machine will run through a full cycle, including RINSE and SPIN.



### Cycle end

- A buzzer will signal the end of the cycle.
- Turn off the water tap.
- Switch off the main power supply to the machine.



### When washing woolens

100% wool garments, wool-polyester knit garments and other delicate fabrics like lingerie can be washed in your Godrej Eon washing machine.

### After putting detergent and laundry,

- Close the lid and turn the power switch ON.
- Press the WOOL key.
- Press Right/Left keys and in SOAK/WASH/RINSE/SPIN select time by pressing Customize key.
- Press START/PAUSE key.

### Caution:

- Articles be washed. Avoid washing articles made of animal fur, (e.g. cashmere, angora, mohair) or lace-knits etc.
- Articles to be washed should be fully soaked using the type of detergent specified on the garment label.
- Lukewarm water of 30°C is ideal for washing wool knit articles.



### 4.3 Types of clothes that can be washed in various Wash Programs

Program	
Daily	Any type of clothing
Delicates	Vest, undergarment, blouse, handkerchief, sock, silk garments, etc.
Wool	All wool garments which are recommended for machine wash by the garment manufacturer.
Heavy	Bed sheet, khaadi fabric, blanket, etc.
Whites	White clothes

### 4.4 How to select Water Level and Load Size

Program		
Water Level Setting	Weight of Clothes	Example of load
4	3.0 - 7.5 kg	3 Trousers, 4 Shirts, 2 Skirts, 2 Nightgowns, 2 Towels, 4 Vests, 2 Sarees, 1 Dhoti, 4 Blouses and 2 Petticoats
3	1.5 - 3.0 kg	1 Trousers, 1 Shirts, 1 Skirt, 1 Night gown, 1 Towel, 3 Vests, 1 Saree, 3 Blouses and 1 Petticoat.
2	0.8 - 1.5 kg	1 Trouser, 1 Shirt, 2 Vests, 1 Night gown, 2 Blouses and 1 Skirt
1	0 - 0.8 kg	1 Trouser, 2 Vests, 2 Undergarments, 1 Blouse

### 4.5 How to Measure Wash load

Here are some of the average weights of commonly used clothes, to help you estimate the weight of the load to be washed.

Approximate weight of clothes			
Item of clothing	Weight (in gms.)	Item of clothing	Weight (in gms.)
Double bedsheet	1000	Single bedsheet	500
Bath towel	500	Table cloth	650
Trousers	400	Jeans	600
Shirt	300	Baggies	500
Saree	500	Petticoat	400
Skirt	250	Pyjamas	400
Dhoti	200	Lungi	225
Night gown	250	Blouse	100
Vest	50	Undergarment	50

While deciding the water requirement for the wash load, check the weight of the clothes and volume occupied by them.

### 2.5 Installing the Rat Mesh

Tilt the washer on the front side and slide the Rat Mesh as shown in fig.1 and screw it to the base as shown in the fig.2

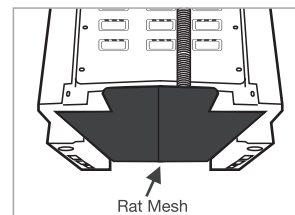

Slide the Rat Mesh into machine base from back side of the machine as shown.

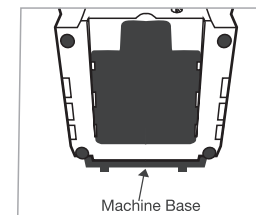

Use 2 nos. screw to fit the Rat Mesh with machine Base as shown.



## 2.6 Attaching the water feed hose to the tap

- Pull the sleeve down with your fingers as you lower the entries hose to disconnect the union
- Loosen the four screws on the hose union and then fit the union exactly over the mouth of the tap.
- Tighten the four screws evenly around the tap.
- Remove the seal from the union and turn the nozzle to tighten securely. (If the tap is large, square or oddly shaped, remove the inside ring to facilitate attachment).
- Grip the ring with your hand and pull it down, and then insert the nozzle. Separate the sleeve until you hear a click, and then push it back.
- After installation, check to ensure that the union does not come off while pulling down.
- Next, confirm that the union is properly installed by turning the water on and checking for leakage.
- If you see any leakage adjust the section where there is a leakage.
- A secure water connection for your automatic washing machine will help you to use the auto start feature.

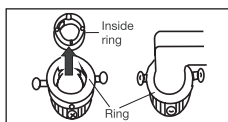
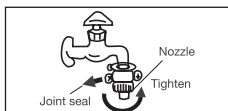
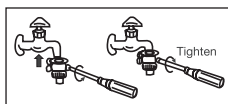
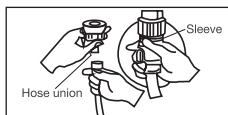

WASH	RINSE 1	RINSE 2	SPIN	*APPROX. TOTAL WASH TIME
18 min(*)	12 min	12 min	4 min	53 min
22 min	12 min	12 min	7 min	60 min
6 min	12 min	12 min	2 min	39 min
22 min	12 min	12 min	7 min	60 min
6 min	12 min	12 min	2 min	38 min
12 min	-	-	8 min	24 min
22 min	15 min	15 min	8 min	59 min (including water heating, time will be approx. 2 hrs.)

\*Approx. Total wash time includes water intake into the machine apart from cycle time.

\*While using Germ Shield feature total washing time will be approximately around 2 hrs (including heating time).

## 4.2 Program Cycles

WASHING PROGRAM	PROCEDURE FOR SETTING WASH CYCLE
Daily	<ul style="list-style-type: none"> <li>• Turn POWER on (Daily cycle gets selected automatically)</li> <li>• Press Start/Hold to start the machine.</li> <li>• Water level and wash time is automatically selected by the machine if not selected manually.</li> </ul>
Heavy	<ul style="list-style-type: none"> <li>• Turn POWER on (Daily cycle gets selected automatically)</li> <li>• Press Heavy key to select Heavy cycle</li> <li>• Press Start/Hold to start the machine.</li> <li>• Water level and wash time is automatically selected by the machine if not selected manually.</li> </ul>
Delicates	<ul style="list-style-type: none"> <li>• Turn POWER on (Daily cycle gets selected automatically)</li> <li>• Press Delicates key</li> <li>• Press Start/Hold to start the machine.</li> <li>• Water level and wash time is automatically selected by the machine if not selected manually.</li> <li>• The user is not allowed to select Warm/Hot function</li> </ul>
Whites	<ul style="list-style-type: none"> <li>• Turn POWER on (Daily cycle gets selected Automatically)</li> <li>• Press Whites key to select Whites cycle</li> <li>• Press start/hold to start the machine.</li> <li>• Water level and wash time is automatically selected by machine if not selected manually.</li> </ul>
Wool	<ul style="list-style-type: none"> <li>• Turn POWER on (Daily cycle gets selected automatically)</li> <li>• Press Wool key to select Wool cycle</li> <li>• Press Start/Hold to start the machine.</li> <li>• Water level and wash time is automatically selected by the machine.</li> <li>• The user is not allowed to select Warm/Hot function</li> </ul>
Tub Clean	<ul style="list-style-type: none"> <li>• Turn POWER on (Daily cycle gets selected automatically)</li> <li>• Press Tub Clean key</li> <li>• Press Start/Hold to start the machine.</li> <li>• Water level and wash time is automatically selected by the machine if not selected manually.</li> <li>• In Tub Clean, Wash and Spin will be performed to clean the tub.</li> </ul>
Germ Shield	<ul style="list-style-type: none"> <li>• Turn power on (Daily cycle gets selected automatically)</li> <li>• Press Germ shield key to select germ shield feature</li> <li>• Press Start/Hold key to start the machine</li> <li>• Water level and wash time automatically selected by the machine.</li> <li>• User can change water level if required</li> <li>• User not allowed to select warm/hot function</li> </ul>

In Daily, Heavy and Whites cycle, inbuilt-soak is added for advanced wash. During in-built soak, machine will remain idle for short duration. Energy label declaration Program - 'Whites' - by default water will be 'High' for energy program. User can change the water and heater level to any other level, however the energy rating will not be considered.

## 2.7 Connecting the water supply hose to your washing machine

- Turn the water intake hose nut clockwise and tighten it on the end of the water supply hose securing it to the water intake hose.
- Tighten further by turning the water supply hose and water intake valve in the direction of the arrow as shown.
- Hold the hose nut firmly. Turn the water supply hose back again only in the direction of the arrow as shown.
- Repeat steps 2 and 3 above, and tighten until you find it difficult to turn the water supply hose further.

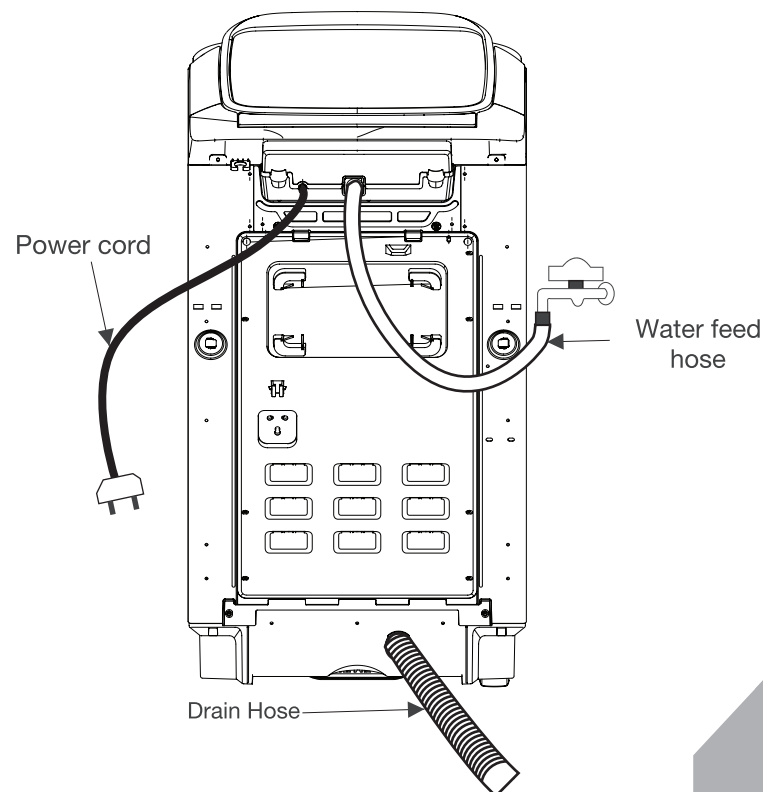
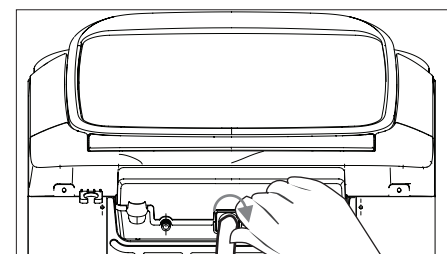

### 3.1 Washing Tips

- Check whether there is anything in the pockets (for example: coin, pins, clips, paper, etc).
- Zips should be zipped close and buttons or hooks should be fixed. The loose band or ribbon should be bound together.
- Do not wash coloured clothes together.
- Follow the instructions on the garment labels while washing laundry items. Avoid washing of all the natural woolens and delicate knits such as lace knits.
- Turn garments inside out when washing to avoid piling and lint.
- Strings and fasteners of aprons and pillow cases should be fastened or tied.
- If the clothes are too dirty, use a towel or soft brush dipped in detergents to rub the dirty part slightly, in the same direction.
- Then put the clothes into the machine.
- The machine may shake heavily in spin when there are only few clothes or single big and heavy dress.
- Add 2~3 pieces of clothes into the tub to reduce vibrations.

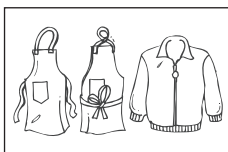
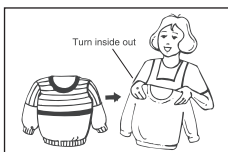

### 3.2 Adding Detergent

Steps for adding detergent for standard program selection and for customized program.

- Add dry cloth load in the tub.
- Turn ON the machine.

For standard program selection:

- Select the desired program and press start key.
- Water will start flowing into tub to a preset water level and will perform load sensing operation by rotating pulsator. After this, machine will indicate approximate number of detergent scoops to be added for washing.
- Now User needs to add detergent in detergent dispenser before water starts filling in the tub for washing.

For customized program:

- User manually selects the water level Detergent indication will display approximate recommended no. of standard scoops based on selected water level.
- Add detergent in detergent dispenser.
- Press the start key.

To get the best wash result check the instructions/guidelines on the detergent pack mentioned by the detergent manufacturers.

### Temperature setting for programs

Program	Temperature Options
Daily	Normal/ Warm/ Hot
Heavy	Normal/ Warm/ Hot
Delicates	Normal/ Warm/ Hot
Whites	Normal/ Warm/ Hot
Wool	Normal
Tub clean	Normal
Germ shield	60°C by default

\*As a safety feature Heater function, cannot be selected in Delicates, Wool & Tub Clean Programs.

### Cloth Load Indication:

- Once start key is pressed & after water level 1 is reached, the machine will sense the cloth load and display the Cloth Load approximately (Low/ Medium/ Heavy). On completing the cloth load sensing, the machine will indicate corresponding water level and add required water before starting the washing cycle.

Displayed weight is an approximated weight of clothes in the tub and only meant for indication purpose to avoid the machine from overloading.

If the machine is displaying erratic cloth load indication, please refer to section 5.4: Fuzzy calibration to re-calibrate the machine.

This feature will not be available for Tub clean program.

### Note:

Accuracy of cloth load indication may deteriorate in high/low voltage conditions.

### Detergent Indication:

- It indicates the approximate recommended number of detergent scoops of standard size to be added in detergent dispenser (for e.g.: 1.0, 1.5 and 2.0 scoops) based on water level and/or cloth load.

### Start/Pause Key

- Press this key either to Start the process or Pause.

### Child Lock

- During on-going program, press Daily key for more than 3 second to activate Child lock.
- Once Child lock is activated, all the key on control panel will get locked until Daily key is pressed same way again and Lock will glow when Child Lock is activated.
- “Child lock” gets deactivated after the program cycle is over.
- During program operation in Child lock mode, if there is a power cut, Child Lock remains active on power resumption.

### Memory Backup

- During program operation if there is a power cut, the machine memorizes the program operation.
- On restoration of incoming power, the machine will resume from exactly where it stopped due to power failure for the remaining process.

### Germ Shield

- Turn Power ON and press Germ shield key to activate germ shield feature.
- Press Start/Hold to start the machine.
- Water level and wash time is automatically selected by the machine.
- However, if user alters wash time and water level, Germ Shield performance may change.
- While using this feature, Total cycle time is approx. 2 hrs and water temperature raises up to 60° C.
- Cloth load of around 3 kgs is to be used for better results.

### ECO Mode

- Before start of program, Press Tub Clean key for more than 3 sec to enable water saving ECO mode.
- ECO mode is applicable for Daily, Heavy and Whites program only.
- The overall water saving is around 20%.

### Heater Function (for select models)

- Heater Function is selected by pressing Left or Right key to bring cursor to “Temp.” at start of washing cycle. By default, Normal temp. is selected. To select heater function, Press Customize key to choose Warm/Hot option. Users are allowed to select the temperature only before starting the Program Cycle.

Cloth Weight	Detergent dosage
0 to 0.8 kg	1.0
0.8 to 1.5 kg	1.0
1.5 to 3.0 kg	1.5
Above 3 kg	2.0

Note: Accuracy of cloth load indication may deteriorate in high/low voltage conditions.

### 3.3 How to Use Softener

When using fabric softener

- Add softener to the softener dispenser located at the top of the basket.
- If the location of the basket makes it difficult to fill dispenser, turn the basket to the right and move it to a more accessible spot.
- Wash as described under washing process.
- For the amount of softener to be used, follow the instructions on the softener label.

Caution:

- Do not open the lid while spinning. It will interfere with the amount of softener dispensed and reduce effectiveness.
- Do not leave the washing machine idle for long periods while filled with softener.

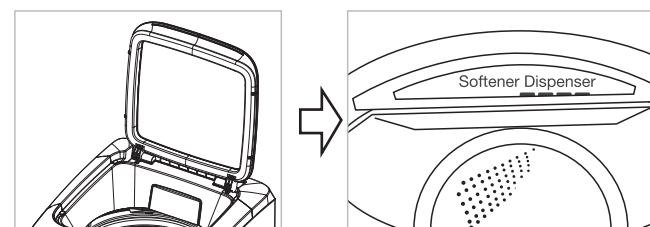

### 3.4 Washing Cycles

Select Process	Operations	Process Cycle
Wash + Spin	<ul style="list-style-type: none"> <li>Press the Power Key of the Machine</li> <li>Press Left / Right Key to select Rinse, Press Customize key to turn it OFF</li> <li>Press Start/Pause key to start of cycle</li> </ul> <p>Note: Not recommended to skip Rinse cycle while using detergent.</p>	
Rinse + Spin	<ul style="list-style-type: none"> <li>Press the Power key of the Machine</li> <li>Press Left/Right key to select Wash, Press Customize key to turn it OFF</li> <li>Press Start/Pause key to start the cycle</li> </ul>	Begins with drain cycle & Spin Cycle- Rinse- Spin
Spin Only	<ul style="list-style-type: none"> <li>Press the Power key of the Machine</li> <li>Press Left / Right key to select Wash, press Customize key to turn it OFF</li> <li>Press Left / Right key to select Rinse, press Customize key to turn it OFF</li> <li>Press Start/Pause key to start the cycle</li> </ul>	Begins with drain cycle-Spin
Soak + Wash + Rinse + Spin	<ul style="list-style-type: none"> <li>Press the Power key of the Machine</li> <li>Press Left / Right key to select Soak, press Customize key to turn it ON and select its time (OFF/15/30 min)</li> <li>Press Start/Pause key to start the cycle</li> </ul>	Soak-Wash- Rinse-Spin
WashOnly	<ul style="list-style-type: none"> <li>Press the Power key of the Machine</li> <li>Press Left / Right key to select Rinse, press Customize key to turn it OFF</li> <li>Press Left / Right key to select Spin, press Customize key to turn it OFF</li> <li>Press Start/Pause key to start cycle</li> </ul>	

#### Wash

- On Selecting the Wash Function by pressing left or right key, the "WASH" cursor will blink.
- The user can change the Wash time from 6-30 min in interval of 2 min (6 & 8 min wash time available in Delicate & Wool program) or deselect the Wash process (select 0 min.), by pressing Customize key.

#### Rinse

- On Selecting the Rinse Function by pressing left or right key, the "Rinse" cursor will blink.
- The user can change the number of times Rinse process should occur (1 to 5 times) or deselect Rinse process (select 0), by pressing Customize key.

Note: 'Not recommended to skip rinse cycle while using detergent

#### Spin

- On Selecting the Spin Function by pressing left or right key, the "Spin" icon will blink.
- The user can change the time of Spin (1-10 min in interval of 1 min, then 15 & 30 min) or deselect Spin process (select 0 min.), by pressing Customize key.

Here is a handy guide to help you customize your wash program:

Customized Programs	Wash (Min)	No of Rinse Level	Spin (Min)	Heater
SportsWear	20	2	6	ON
Baby Care	6	2	6	ON
Denim	20	2	4	OFF
Synthetic	6	1	3	OFF
Curtains	10	2	3	OFF
Blanket	16	3	5	OFF
Inners	6	2	1	OFF
Saree	10	2	3	OFF
Quick Wash	6	1	4	OFF

#### Note:

- Heater function is only available in select models.
- The above customizations can be done by initially selecting either the preset Delicate or Wool program and changing the wash, spin and rinse timing according to the above chart.
- A soak timing of 15/30 mins can be added to each of the above programs based on the dirt levels.
- You can choose to set your own preferred programs by choosing from 4 water levels, 3 pre-soak levels, 14 wash timings, 6 rinse levels and 13 spin timings, to get the most optimal wash as per your load.



#### 4.1 Operation of Functions (Manual selection)

##### Program Selection

- Press any Program key to select the required program (Daily/Heavy/Delicates/Whites/Wool/Tub Clean). The respective program will be selected and Light will glow. Once required program is selected, press START key to activate the selected program.
- The user can deactivate by pressing Pause key and selecting another Program key.
- The remaining time for the selected program is displayed on seven segment display in Minutes.

##### Functions

- Press Left or Right arrow keys to select the required Functions. With each press, the respective Function will be selected, Cursor Light will blink. Once required Function is selected, press Customize key to change the required values (i.e.) Water temp\*, Water level, Start After (Delay Start) time, Soak/Wash/Rinse/Spin and time.

##### Water Level

- During fuzzy sensing, once minimum water level (1) is filled, cloth load sensing is done to automatically select the water level with respect to cloth weight.
- The user can change the water level assigned by fuzzy sensing.
- Water level Function is selected by pressing Left or Right key, the "Litres" cursor will blink.
- Then water level can be changed by pressing Customize key.

##### Start After (Delay Start)

- This Function is selected by pressing left or right key, the "hrs" cursor will blink.
- The user can choose Start After time (0-9 hrs) by pressing Customize key. Default value is 0hrs.
- The user can deselect Start After process by selecting 0. Once 0 hours is selected "Start After" will go off.

##### Soak

- Soak Function is selected by pressing left or right key, the "SOAK" cursor will blink.
- The user can choose Soak time (OFF/15min/30min) by pressing Customize key. By default, Soak is OFF.
- The user can deselect Soak process by selecting OFF. Once OFF is selected "SOAK" will go off.

\* Available in selected models only

Select Process	Operations	Process Cycle
Rinse Only	<ul style="list-style-type: none"> <li>• Press the Power key of the Machine</li> <li>• Press Left / Right key to select Wash, press Customize key to turn it OFF</li> <li>• Press Left / Right key to select Spin, press Customize key to turn it OFF</li> <li>• Press Start/Pause key to start the cycle</li> </ul>	<p>Begins with drain cycle &amp; Spin</p> <p>Cycle-Rinse-Stop without draining.</p>
Soak + Wash + Rinse	<ul style="list-style-type: none"> <li>• Press the Power key of the Machine</li> <li>• Press Left / Right key to select Soak, press Customize key to turn it ON and select its time (OFF/15/30 min)</li> <li>• Press Left / Right key to select Spin, press Customize key to turn it OFF</li> <li>• Press Start/Pause key to start the cycle</li> </ul>	<p>Soak-Wash-Rinse-Stop without draining</p>
Wash + Rinse	<ul style="list-style-type: none"> <li>• Press the Power key of the Machine</li> <li>• Press Left / Right key to select Spin, press Customize key to turn it OFF</li> <li>• Press Start/Pause key to start the cycle</li> </ul>	<p>Wash-Rinse-Stop without draining</p>

Note: Like wise many combinations of soak, wash ,rinse and spin can be selected.



100  
95  
75  
25  
5  
0

100  
95  
75  
25  
5  
0

