

HOW TO GET THE BEST OUT OF YOUR GODREJ WASHING MACHINE...

Protection of Environment:

Protection of environment" is one of the core values of Godrej and we seek your co-operation to make sure that the product, packaging and plastic material is not disposed as unsorted municipal waste.



This symbol is known as the "Crossed-out Wheellie Bin Symbol". It means that the product should not be disposed of with your general house-hold waste.

It should be disposed of only through the company's collection points with special treatment so as to prevent any damage to the environment. Please call: **1800 209 5511** for applicable buy back arrangement or visit: www.godrejappliances.com/green-think for details about Godrej Appliances authorised collection points.

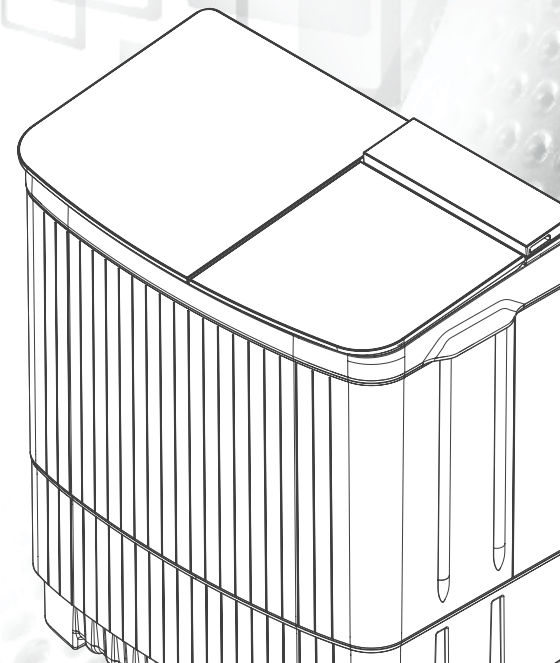

13. WARRANTY

The GODREJ WASHING MACHINE comes with 5 YEARS warranty on wash motor. 2 Years warranty on rest of functional parts of appliance from the date of purchase, against defective material or workmanship. In case of any such defect, Godrej & Boyce Mfg. Co. Ltd. - Appliance Division undertakes to get the appliance repaired free of charge during warranty period, subject to terms and conditions below.

INSTRUCTIONS FOR THE CUSTOMER

1. Kindly ensure that the dealer fills the warranty card correctly and completely.
2. You should retain the warranty card for record and produce the same in the event of any warranty repairs.
3. In the event of a defect developing in the product, contact the nearest authorised Godrej & Boyce Service Centre for obtaining warranty service and provide the defect, Model details & Serial No.
4. Product will function between +/- 5% of rated volts. For any fluctuation beyond specified limit, company shall not be responsible. In turn, warranty stands terminated.
5. Earthing provision is necessary for the safety.
6. Frequency must be between 5% variation of 50Hz. Beyond this, company shall not be liable for any unforeseen hazards like fire, shock etc. & in turn, warranty stands terminated.
7. Appliance or any part thereof is subjected to neglect, abuse or misuse, tampering, alteration, accident, fire, floods or other act of God, or damage by rodents or insects, the COMPANY is not responsible for any damage caused to the appliances & shall not be liable for any consequential loss or compensation, not refund of purchase price or replacement of the appliances.
8. In event of repair/replacement of any part/s of the unit, this warranty will thereafter continue and remain in force only for the unexpired period of warranty. Moreover, the time taken for repair/ replacement and in transit whether under the warranty or otherwise shall not be excluded from the warranty period.
9. Any damage/defect arising due to entry of coin/foreign particle into the machine, and causes malfunctioning is not covered under warranty. These calls will be chargeable to customer during warranty period.
10. House wiring related issues are not covered under warranty and such calls will be chargeable to customer.
11. Calls related to lint filter or water inlet filter cleaning are not covered under warranty and are chargeable to customer.

TERMS AND CONDITIONS

1. Repairs and replacement of parts will be carried out through the Authorised Customer Service Centre.
2. All transportation and handling expenses incurred while repairing will be payable by the customer.
3. For appliances installed beyond the municipal limits of the jurisdiction of the authorised service centre, charges towards technician's visit and other incidentals will be borne by the customer.
4. While the company will make every effort to carry out the repairs at the earliest, it however is made expressly clear that the company is under no obligation to do so in a specified period of time.
5. The company/its authorised service center will collect any parts, components replaced.
6. Warranty does not cover accessories to the appliance.
7. The company's obligation under this warranty shall be limited to repair or providing replacement of part/s only. The maximum claim/s if entertained by the company will be subject to the maximum retail price of the product purchased or purchase price, whichever is lower.
8. In the event of any unforeseen circumstances, and spares not being available, the company's prevailing depreciation rules will be binding on the purchaser to accept as a commercial solution in lieu of repairs.
9. Warranty is not applicable in case the original number (serial no. sticker) is removed, obliterated or altered from the machine or cabinet.

Godrej & Boyce Mfg. Co. Ltd.- Appliance Division CUSTOMER COPY

MODEL NO.
UNIT SR. NO.

DATE OF PURCHASE

CUSTOMER'S NAME & ADDRESS

DEALER'S NAME & ADDRESS

TEL. _____

TEL. _____

Customer's Signature:

This warranty is valid only if it is filled in and stamped by our authorised dealer stating the date of purchase.
Warranty Voids If: 1. The warranty card is not completed properly at the time of purchase. 2. The completed warranty card is not presented to the authorised personnel at the time of service of the product. 3. The appliance is not operated according to instructions given in the 'User Guide'. 4. Defects are caused by improper use, which shall be determined by the company's authorised personnel. 5. Unauthorised persons carry out any repair work. 6. Defects are caused by reasons beyond control, like abnormal voltage, acts of God or while in transit to service centre or purchaser's residence. 7. The warranty is not valid in case the serial number is deleted, defaced or altered. 8. Damage to the appliance or any parts due to transportation or shifting is not covered by the warranty. 9. The warranty automatically expires after 2 years from the original date of purchase, even if the appliance may not have been in use for any time for whatever reasons during the warranty period.

Contents

1.	Description of parts & specification	1
2.	Safety instructions	
2.1	Safety instruction	2
2.2	Recommendation	2
2.3	Environment & Energy Conservation Suggestion	2
2.4	Ensuring Proper Earthing	3
3.	Features	
3.1	Active soak	4
4.	How to install	
4.1	Choosing the right location to install	5
4.2	Step-by-step installation	6
5.	How to wash	
5.1	Precaution before washing	6
5.2	Washing	7
6.	How to do intermediate spinning	
6.1	How to use the spin shower	8
7.	How to rinse	
7.1	Overflow rinse	8
7.2	Caution	9
7.3	Rinsing with fixed amount of water	9
8.	How to spin	
8.1	Ending the process	10
8.2	Caution	10
9.	How to measure wash load & washing guide	11
10.	Caution	12
11.	Lint filter cleaning instructions	
11.1	How to clean the wash tub	13
11.2	Cleaning the magic filter	13
12.	Service Centre	14
13.	Warranty	15

1. DESCRIPTION OF PARTS & SPECIFICATIONS

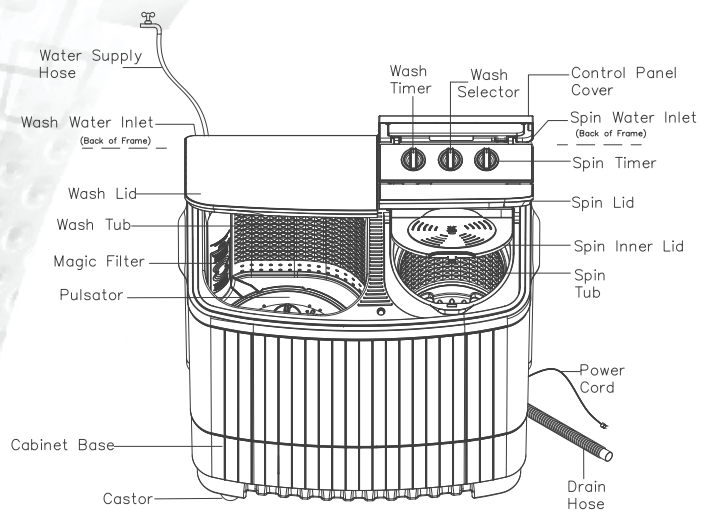

Model	WSEEDGE ULTS 85 5.0 DB2M	
Capacity	8.5 Kg	
Pulsator type	Tri-Roto Scrub	
Power source	230 V,AC,50 Hz	
Input Wattage	Wash	460 W
	Spin	200 W
Water consumption	High	75 Ltrs
	Low	50 Ltrs
Net dimension (WxDxH) mm	821 x 492 x 975	
Net weight (Kg)	30.2 Kg	

In view of Godrej policy of continuous development & improvement, specification may change without prior notice.

Images shown in the user manual are for illustration purpose only.

12. BRANCH ADDRESSES / SERVICE CONNECT

Branch	Branch Addresses	Service Connect
Ahmedabad	4th Floor, APM Shopping Mall Near IOCL Petrol Pump, Shyamal-Karnavati, 100 Ft. Road, Satellite, Ahmedabad 380 015.	<p>Call 1800-209-5511 (Toll-Free)</p>
Bangalore	3rd Floor, The Karnataka Film Chamber of Commerce Building, 28, 1st Main, Crescent Road, High Grounds Near Shivanand Circle, Bangalore 560 001.	
Bhopal	217, Zone I, M.P. Nagar, Behind Jyoti Talkies, Bhopal 462 011.	
Bhubaneshwar	Highway Complex, NH-5, Rudrapur, Bhubaneshwar 752 101.	
Chandigarh / Mohali	Plot No. A-40, Phase-VIII-A, Industrial Area, Mohali 160 059 (Punjab).	
Chennai	No.1, Sidco Industrial Estate, Ambattur, Chennai 600 098.	
Coimbatore	1st Floor, Gowtham Arcade, T.V. Samy Road East, R.S. Puram, Coimbatore 641 002.	
Delhi	Godrej Bhavan, 2nd Floor, Shershah Suri Marg, Okhla, New Delhi 110 065.	
Faridabad	Godrej Bhavan, 2nd Floor, Shershah Suri Marg, Okhla, New Delhi 110 065.	
Ghaziabad	Godrej Bhavan, 2nd Floor, Shershah Suri Marg, Okhla, New Delhi 110 065.	
Goa Service Centre	Shed A-1, Corlim Industrial Estate, Opp. Telephone Exchange, Corlim, Goa 403 110.	
Guwahati	Godrej Building, G.S.Road, Ulubarii, Flyover, Guwahati 781 007.	
Hyderabad	201 & 202, Lala-1 Land Mark, 5-4-94 to 97, 2nd Floor, Above Digital Shoppy, Ranigunj, M.G. Road, Secunderabad 500 003.	
Jaipur	502-506, 5th Floor, Gaurav Towers, Malviya Nagar, Jaipur 302 017.	
Kochi	Near Info Park, Edachira, Thengode P.O., Kakkannad, Kochi 682 030.	
Kolkata	Block GN, Sector V, Salt Lake, Kolkata 700 091.	
Lucknow	C 3/3 & C3/4, Sanjay Complex, Behind Akashwani Bhawan, Vidhan Sabha Marg, Lucknow.	
Mumbai	Appliance Division, Plant 4, Pirojshanagar, Vikhroli, Mumbai 400 079.	
Patna	Jeevan Deep Building, Exhibition Road, Patna 800 001.	
Pune	Apolo Square Building, Plot No. 60, Sr. No. 599, Sahane Sujan Park, Lullanagar- Bibwewadi Road, Lullanagar, Pune - 411 040	
Ranchi	C/o. Surya Motors, Pandra, Ranchi (Jharkhand).	

Website: www.godrejsmartcare.com & www.godrejappliances.com
E-mail: smartcare@godrej.com SMS: <godrej><space><care> to 53636

11. LINT FILTER CLEANING INSTRUCTIONS

Most Important: Before you start cleaning the tub of your washing machine, please ensure electrical plug pin is disconnected/unplugged from mains power supply socket.

11.1 How to clean the wash tub

- If the wash tub becomes dirty, clean it with a mild soap and soft brush. Do not use a scrubber or hard brush as this could scratch the wash tub.

11.2 Cleaning of the Magic filter

Clean the Lint Filter after every wash. Follow these steps:

- To remove the lint filter, press the latch/lock which is there on top of the filter, & pull it outward simultaneously.
- Open the lint filter back as shown by pulling it out.
- Clean the filter in running water to remove all collected lint particles.
- When the lint filter has been emptied and cleaned, close the lint filter back. To assemble it in machine first locate bottom part of lint filter and then push it in the direction of the arrow, as shown. a click sound of the latch will confirm that the lid filter is locked in the tub.

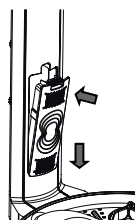
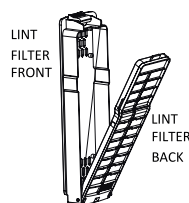
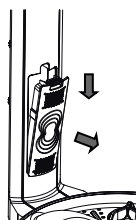

2. SAFETY INSTRUCTIONS

2.1 Safety instruction

- Ensure that the earthing connection in your electric supply is proper before connecting the power cord.
- Do not use the extension cord as they may not be properly earthed.
- Connect the machine to socket having current & voltage rating specified on the power cord plug.
- Remove the power plug before moving the machine from its place.
- Only authorised personnel should repair the machine, warranty stands cancelled if repairs are done by an unauthorized personnel.
- Do not put washing machine in very wet places or near water leakage.
- Check if drain hose is placed correctly so that water drains out smoothly.
- Kids are forbidden to play with washing machine. Keep pets away from the washing machine.

2.2 Recommendations

- Use a secure tap connection to avoid leakage & wastage of water.
- Do not use wet hands to insert or pull out the power cord.
- Pull out the power cord when the machine operation is completed (or) under repair (or) during the cleaning process.

2.3 Environment & energy conservation suggestion

- After installing the machine, recycle/reuse the corrugated box.
- Fitments and polythene cover/straps: do not dispose them off as garbage. This helps to conserve natural resource and prevents pollution.
- Use correct quantity of water depending upon the quantity of clothes to be washed.
- Use less foam making detergent for washing and use correct quantity of detergent.
- Use the correct wash cycle. This helps in saving electricity & water.
- At the end of cycle, please switch off the machine from mains.
- Reuse the soapy water if possible.

2.4 Ensuring Proper Earthing

- Your washing machine has three core power cord to connect the machine to the power line. Make sure that electrical and earthing connections are done properly in the wall socket. Live and Neutral connections in socket should be as per standard.
- Connect the power cord to Indian standard 3 pin power socket. Never plug it into an ungrounded power socket

Grounding Method

- Earth wire must be connected in the wall socket. If the Earth wire is not connected, then there is a potential hazard of electric shock caused by the current leakage.
- Note that AC power outlet configurations may differ from country to country.
- If the external socket does not have grounding terminal, then a separate grounding is needed.

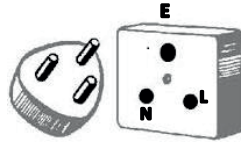

Other Grounding Methods (any one to be followed)

Burying copper plate:

- Connect the Ground Wire to a Ground Copper Plate and bury it more than 75cm in the ground (by a qualified Engineer)

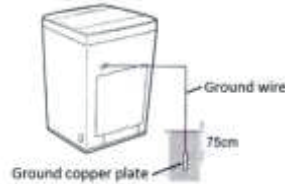

Using a short-circuit breaker:

- If the grounding methods described above is not possible, a separate earth leakage circuit breaker should be employed and installed by a qualified Engineer.

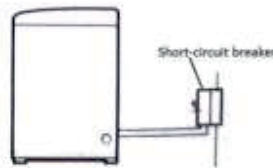





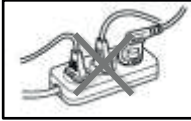

Never connect ground to:

- A Gas pipe, Telephone Wire, lightning rod, Neutral, Extension cords without ground terminals, plastic, etc.

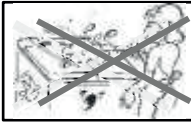
Note: All electrical wirings & modifications should be done by a qualified Engineer only.

10. CAUTION

<p>The washing machine should be plugged into separate power socket. Do not take power supply for other appliance from the same source.</p> 	<p>Avoid installation of the machine in the area exposed to high humidity, snow, rain or direct sunlight. It may cause electric shock, discolour deformation in the product.</p> 
<p>Do not spill water on control panel, this may lead to electric shock. Do not try to clean the control panel with chemicals like benzene, thinner etc. This may deform the parts or colour may fade.</p> 	<p>Never put organic chemicals like benzene, alcohol or thinner or even clothes stained with such chemicals in the washing machine as this may lead to fire hazard or damage to the machine.</p> 
<p>It is necessary to use spin cap for the spinning operation. The cap holds the clothes in its place during spinning and prevents them from flying off.</p> 	<p>Never put your hands in spin tub while it is rotating.</p> 
<p>If the spin lid is open and rotations do not stop within 15 seconds, it indicates that self-acting brakes are malfunctioning. Called up the Godrej helpline & get the machine repaired immediately by authorised service personnel.</p>	<p>Do not pour hot water of temperatures above 50 degrees into wash or spin tub as this may result in deformation & damage to plastic parts.</p> 
<p>Switch off the power supply immediately if the supply voltage drops abnormally. Low Voltage power supply may result in overheating of electric parts of the machine.</p>	<p>Do not keep lit matches, cigarettes or candles near or on the machine as plastic parts in your machine may deform or catch fire.</p>

9. HOW TO MEASURE WASH LOAD AND WASHING GUIDE

Here are some of the average weights of commonly used clothes, to help you estimate the weight of the load to be washed.

Approximate dry weight of clothes (grams)			
Item of clothing	Weight	Item of clothing	Weight
Double bed sheets	1000	Single bed sheets	500
Bath towels	500	Table cloth	650
Trousers	400	Jeans	600
Shirt	300	Baggies	500
Sari	500	Petticoat	400
Pyjamas	400	Dhoti	200
Skirt	250	Nightgown	250
Lungi	225	Banian	50
Blouse	100	Undergarment	50

How to select wash cycle settings, wash time and water level.

Washing (Weight)	Water level	Cycle Setting	Fabric Material	Wash Time
Less than 2.6 Kgs	Low	Regular	Synthetic, Woolen	5 mins
			Cotton hand spun	7 mins
2.6 - 5.5 Kgs.	Medium	Regular	Spoiled cotton, Hand spun, School School uniforms	10 mins
			Synthetic clothes	10 mins
5.5 - Max Kgs.	High	Strong	Cotton, Linen	7-10 mins
			Soiled cotton, Bed Sheets, Pillow covers, Towels, School Uniforms	10-15 mins

* For Energy saving course refer below instructions in Wash/Rinse/Spin function.

1. Select "Regular" wash program and fill water up to mark "High" in wash tub.
2. Refer following function & time selection:



*Under test conditions, when tested in accordance with standard IEC 60456 : 2010 & BEE Schedule -12 (Revision : 03).

Actual Performance of machine will depend on how the appliance is being used.

3. FEATURES

2 wash cycles	Choose between Regular and Strong depending upon the kind of fabric you wish to wash.
Water level indicator	This indicates the level of water, that suits the cloth load being washed, ensuring a more effective wash and preventing wastage of water.
3 rinse option	This feature ensures effective removal of detergent with continuous stream of water so that no suds or detergent deposits are left behind on the fabric. Thus the fabric and your skin are safe.
Spin shower facility	This facility in the spin drying tub ensures that all leftover detergent is removed effectively.
Liquid balancing Ring on the spin Tub	Liquid filled in the balancing helps to distributes the wash load evenly in the tub so that the machine does not shake during rotation of spin tub.
Separate wash & Spin timers	This feature gives you the convenience of washing and spin drying the clothes simultaneously.

3.1 Active soak

Your Godrej washing machine provides you the flexibility of soaking your bed sheets or heavily soiled clothes in the wash tub itself to facilitate better detergent action. During Active soak, pulsator will rotate for 1.5 minutes followed by a 5 minute pause. This cycle will continue for the selected soak time.

To set the washing machine into soak mode, put your wash load into the machine wash tub. Add desired amount of detergent. Fill water to the set level. Select one of the two cycles using the wash selector.

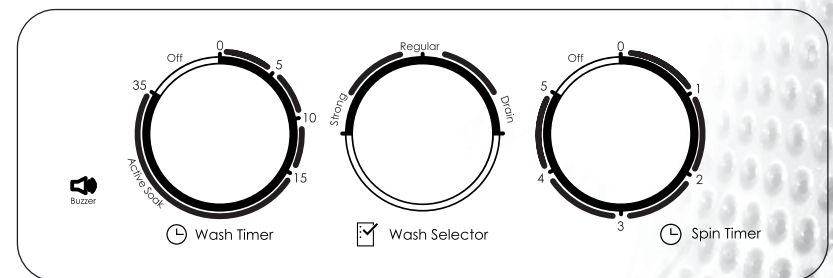

When you want to	Set wash Timer knob to	Approximate Total time (min)	Approximate Soak time (min)	Approximate Wash time (min)
Soak and Wash heavily Soiled clothes	Long soak, set by Turning knob fully	35	20	15
Soak and Wash Not so heavily Soiled clothes	Midway of Soak timer	25	10	15
Quick soak and full wash	Short position of Soak timer	20	5	15

4. HOW TO INSTALL

4.1 Choosing the right location

Removal of packaging material

- Please ensure all packaging / bottom cushion to be removed from the machine before starting machine.
- CAUTION: Operating the machine with the packaging may cause movement/unbalanced condition and can damage the machine parts.

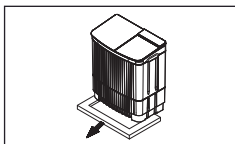

Install your Godrej Washing machine in an even, stable & levelled surface.

An unstable location:

- Can be dangerous since vibrations may cause your machine to move
- Can create noise as your machine may vibrate

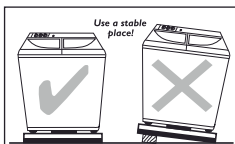

Keep a distance of at least 5 cm between the sides, rear of your machine and the nearest wall. This will reduce noise while operating the machine as well as ensure proper ventilation.

Do not place your machine in an area with high humidity or direct exposure to sunlight or rain.

This can:

- Result in damaged insulation & a shock hazard.
- Cause deformation or discolouration of plastic parts

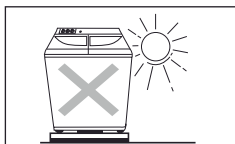

The washing machine is provided with casters & wheel which gives flexibility to move the machine to a convenient location free from high humidity and direct sunlight.

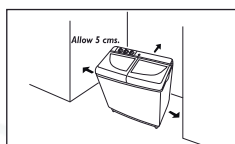

8. HOW TO SPIN

- Remove washed clothes from wash tub and transfer clothes uniformly into spin tub as shown in Fig A.

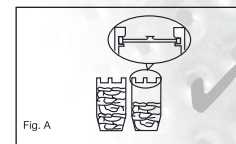

The spin cap must be placed horizontally above clothes as shown in Fig A. Even in case of small lot of clothes spin cap must be placed above clothes. This is a safety requirement.

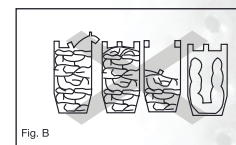

The clothes and the spin cap should not be placed as shown in Fig. B, as this could lead to vibrations and cause a rattling sound during spin cycle.

- Close the spin inner lid and spin lid

Note: Spinning will not start till the spin lid is close completely. For safety reasons this machine is provided with brake mechanism which gets activated as soon as the spin lid is opened. This is a safeguard against accidental opening of spin lid when the tub is spinning at a high speed.

- Set the spin timer by turning the spin timer clockwise. Refer to the table on right side providing guidelines for setting spin time.
- Once the set spin time is over, the timer returns to its original position and the spinning activity stops

Type of Fabric	Spin Time
Synthetic Clothes	1 minute
Woolens	1-2 minutes
Shirts / Trousers	2-3 minutes
Bedsheets/ Towels	5 minutes

8.1 Ending the process

- Switch off main power supply and unplug the power cord
- Drain the water completely from drain pipe. Then hang the drainage hose on the hook provided on the side of the machine.
- Shift the Wash Selector knob to Regular/Strong position.

8.2 Caution

- If bleaching powder or starch is used for washing, rinse the wash tub and spin tub with water and drain. This is required to remove any leftover bleach/starch which may otherwise damage the Wash/Spin tub.
- Remove the water supply joint first and then remove the water supply hose as this prevents water from spilling on to the controls of machine

- Transfer the wash clothes from spin tub to wash tub after intermediate spin cycle .
- Connect the water supply hose to wash side.
- Shift the wash selector knob to Regular/ Strong position.
- Start the flow of water, and set the wash timer between 6-8 minutes and rinse under continuous water flow .
- For best results repeat this process twice .

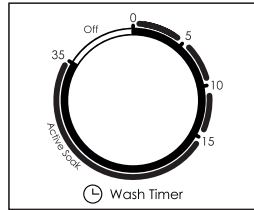

7.2 Caution

- Adjust the water flow while looking at the water level or water may spill out (Refer Image A) .
- Cover the wash tub with wash tub lid while rinsing using “Overflow rinse” option as this will prevent water spilling/splashing.

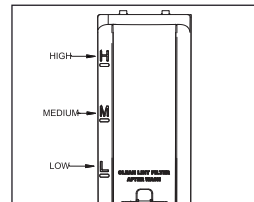
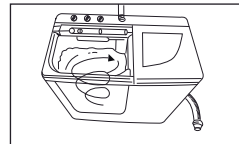

Image A

7.3 Rinsing with fixed amount of water

- Transfer the washed clothes from the spin tub to the wash tub after intermediate spin cycle.



- Shift the Wash Selector knob from Drain to Regular/ Strong position.

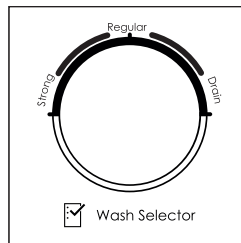

- Fill water up to “High” level. Set the wash timer to 5 minutes.
- After the rinsing cycle is over, shift the Wash selector knob to 'Drain position'. This will drain out the water from wash tub. Wash operation will not work if selector knob is set to drain.
- Transfer the clothes to spin tub for intermediate spinning .
- Repeat this process two to three times for best results .

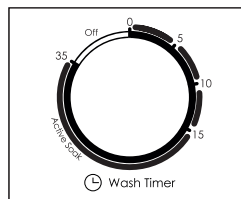

4.2 Step-by-step installation

- Lower the drain hose to the floor. Make sure that the drain hose is not kept too high, else it may not drain water from the tub properly.

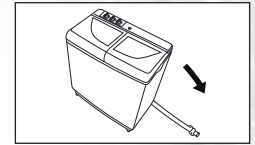

- Connect the water supply pipe to water inlet.

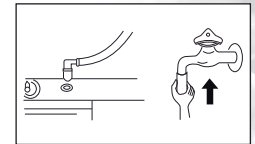

- Plug in the power cord into power supply socket. This machine requires a 230 V, 50 Hz, 5 Amp AC supply.
- Place your machine on level ground, if the floor is uneven, place a board underneath and bring it to level position
- To check if your machine is on level ground, use a weight attached to a string. The distance between the string and your machine should be the same from top to bottom.

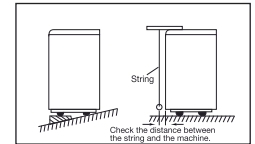

*The images are for representation purpose only. Do not match it with your machine.

5. HOW TO WASH

5.1 Precaution before washing

- Put your delicate cloth and undergarments in a washing net. This will prevent clothes from getting entangled during wash and protect them. The washing nets are easily available in the market.



- Strings of aprons, petticoats, pyjamas etc. should be tied as this will prevent clothes from getting entangled

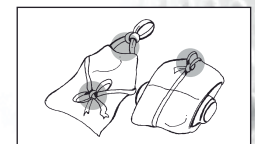

- Close fastener/zippers of trousers and jeans as this will prevent scratching of wash tub

- Remove articles like match sticks, hair pins etc. from pockets before washing.



5.2 Washing

- Connect the water supply hose to wash side and set the wash selector knob to Regular/ Strong position.
- Maintain the water level depending upon the cloth load (Refer to page 11 on how to estimate wash load and select the water level).
- Turn on the water supply and allow water to fill 2-3 cm lower than water level selected.
- Add the detergent and mix properly, so that detergent dissolves fully in water.
- Now put the cloth load into wash tub and fill water up to water level selected.

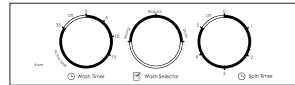

- Select the required wash program for washing depending upon quantity of clothes to be washed, the type of fabric and the dirt levels of the clothes. Refer to page 11 for guidance on selecting wash program Choose between Regular & Strong by turning the wash selector knob.
- Select the wash time required. This time will vary depending on the number of clothes and type of fabric. (Refer to page 11 for guidelines on setting wash time.)
- Set the wash time by turning the wash timer clockwise. The machine starts working immediately on turning the knob. A buzzer will indicate the completion of wash cycle. After washing has stopped, shift the Wash selector knob to 'Drain' position to drain out the water from the wash tub.

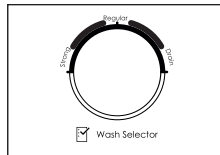

6. HOW TO DO INTERMEDIATE SPINNING

- After completion of the wash cycle it is suggested that an intermediate spin cycle with the spin shower facility to be carried out. This helps to remove the detergent solution from clothes and rinsing becomes more effective.

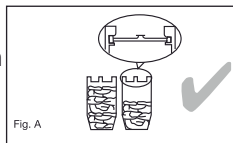

7

6.1 How to use the spin shower

- Remove washed clothes from wash tub and transfer them uniformly into the spin tub as shown in Fig A
- The spin cap needs to be placed horizontally above clothes as shown in Fig A. Even in case of small lot of clothes spin cap should be placed above clothes. This is a safety requirement. The clothes and spin cap should not be placed as shown in Fig B as this could lead to vibrations and cause a rattling sound during spin cycle.

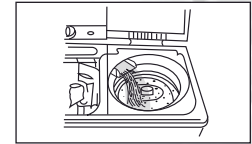
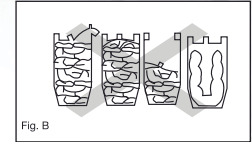

- Connect water inlet hose to 'Spin' side and allow water to flow for 1 minute.
- Turn off the water supply, close the spin inner lid and spin lid.

Note: Spinning will not start till the spin lid is closed completely. For safety reasons this machine is provided with brake mechanism which gets activated as soon as the spin lid is opened. This is a safeguard against accidental opening of spin lid when the tub is spinning at a high speed.

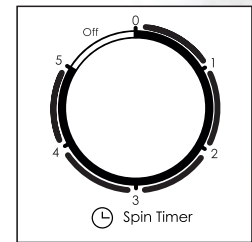

Set the spin timer by turning the knob clockwise. Choose between 1-5 minutes depending upon type and no of clothes. For details refer to page 10.

*It is recommended not to perform spin operation when tap is open. This will make sure that water reaches all the clothes inside the basket, before spinning begins

7. HOW TO RINSE

- After the wash and intermediate spin cycle, use the rinse cycle. This helps to remove detergent from the clothes and makes them soap-free. Rinsing can be done in two ways:

7.1 Overflow Rinse

In this mode water is continuously supplied to wash tub during rinsing and the dirty water flows out through the drain hose. In this mode very efficient rinsing can be done since concentration of detergent in water is lowered significantly



8