



**VERY
IMPORTANT**

Please read the
water filling instructions
on page 10

- **User and maintenance instruction manual**

Keep these instructions close to the Refrigerator

* Above image is for illustration purpose only. Actual product may vary.

MAINS POWERED FRIDGE FREEZER

MODEL NUMBER: GVR 55 FF AC

TABLE OF CONTENT

CONTENT DESCRIPTION	Page No.
User instructions	3
General	3
Installation	3
Operation	3
Decommissioning and disposal	3
R600a Refrigerant Warnings	4
Main components	5
Operating instructions	6
Normal operation	6
Shelves	6
Temperature control	6
Drip tray	6
Water-pack freezing instruction	7
User Maintenance	8
Daily	8
Weekly	8
Monthly	8
Installation instructions	9
You will need	9
Transport and handling	9
Positioning	9
Leveling	10
Water filling instructions	10
Switching On	11
Handover	11
Relocating the refrigerator	11
Technical Section	12
Preventative maintenance	12
Every 6 to 12 months	12
Environment and use	12
Equipment	12
Operation	12
Defrosting	12
Fault finding	13
Getting technical help	14
Specifications	15
Electrical	15
Wiring Diagram	16
Inbuilt voltage stabilizer	16
Operating voltage	17
Controller PCB	17
Spare parts	18
Refrigeration Circuit Product Disposal WEEE Regulations	20
Recycling information	20
Customer support	20

USER INSTRUCTIONS

When using electrical appliances, basic safety precautions should be followed including the following:

General

- Caution! Appliance contains flammable refrigerant and capacitor that can hold charge at dangerous voltages even when the power is switched off.
- Do not climb on appliance.

Installation

- This refrigerator must be properly located and installed according to the installation instructions before it is switched ON.
- Empty the appliance of liquid by siphoning before moving.

Operation

- Always turn off the unit and isolate it before removing the top cover.
- Do not store flammable vapors or liquids near the appliance.
- Servicing should only be performed by a qualified technician.

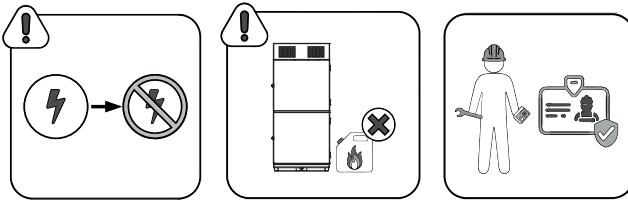

Decommissioning and disposal

- **Danger! Risk of child entrapment – Remove the door before you dispose of your refrigerator.**
- This unit contains flammable R600a refrigerant – this must be disposed of safely in accordance with the national regulations.
- Advice to customers for end-of-life disposal of our products
Each country will have its own laws regarding decommissioning of appliances, and customers are advised to adhere to relevant in-country procedures during the process of writing-off and physically disposing of equipment that is no longer effective.
- It is responsibility of the user to ensure that the product is disposed of properly.
- For more information, please visit: <http://www.surechill.com/disposal/>

R600a Refrigerant Warnings

1. Risk of Fire/Flammable materials.
2. Keep ventilation openings, in the appliance enclosure or in the built-in structure, clear of obstruction.
3. Do not damage the refrigerant circuit.
4. Do not use electrical appliances inside the storage compartments of the appliance, unless they are of the type recommended by the manufacturer.
5. Do not store explosive substances such as aerosol cans with flammable propellant in this appliance.
6. This appliance contains a small quantity of flammable non-synthetic R600a refrigerant.
7. Do not use mechanical devices or other means to accelerate the defrosting process, other than those recommended by the manufacturer.
8. Ensure that the tubing of the refrigerant circuit is not damaged during transportation and installation.
9. Ensure careful installing, handling and disposing to avoid safety hazards. If accidental damage occurs, keep appliance away from open fires or devices that produce sparks, unplug the appliance and call an authorized service agent. Thoroughly ventilate the room in which the appliance is situated for several minutes.

Main Components

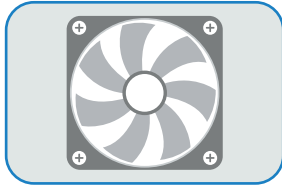

• Condenser fan

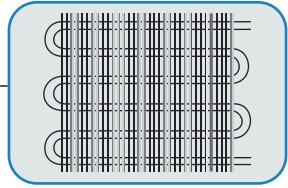

• Condenser

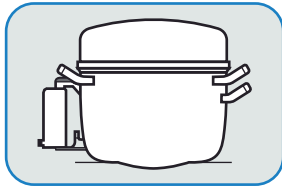

• Compressor and controller

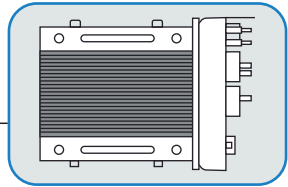

• Voltage stabiliser

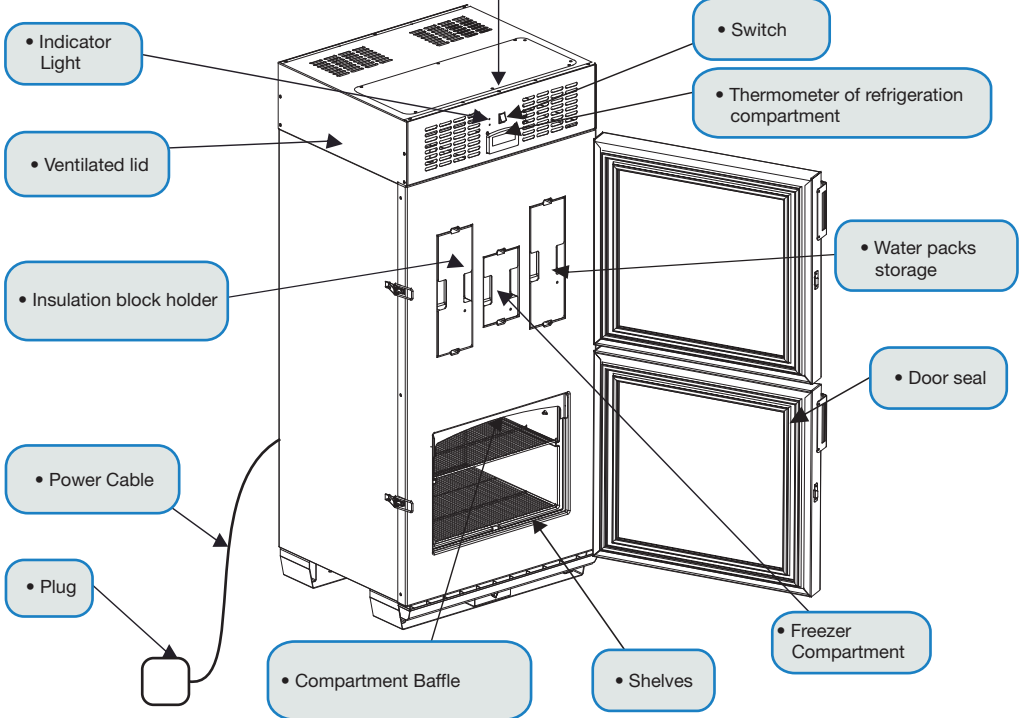

* Above image is for illustration purposes only. Actual product may vary

OPERATING INSTRUCTIONS

Normal operation

- Compartment temperature is displayed on appliance in °C on the thermometer / temperature recorder e.g. Fridge-tag.
- The refrigerator automatically operates between 2°C and 8°C.
- It is normal for the refrigerator to be cooled to 2-8°C within 6-8 days after commissioning. Do not store vaccines in the refrigerator during this time.
- Fans operate and are audible when the compressors are working .
- Always secure both latches every time the refrigerator door is closed.
- The appliance does not require defrosting.
- Do not switch on appliance before filling with water. See commissioning instructions below.

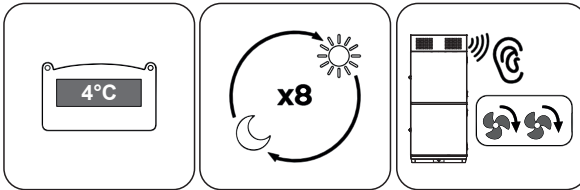

Shelves

Shelves are fitted for separation and storage of vaccines and easy stock control. They are designed to be slightly tight within the cabinet to avoid movement. Keep the shelves clean.

Temperature control

Operating temperature is set during manufacture. There is no need for any user adjustment.

The vaccine storage compartment temperature should be between 2°C and 8°C. If the thermometer or temperature recorder indicates any other temperatures, then refer to the troubleshooting section of this manual.

Drip tray

In humid conditions, warm damp air will enter the refrigerator every time the door is opened.

Once the door closes, the air cools down and the moisture will condense on the walls. This will run down to the bottom of the vaccine compartment where there is a drain hole and water seal. The condensation will then collect in a removable drip tray mounted underneath the front of the refrigerator.

In humid conditions the drip tray should be checked and emptied every few days.

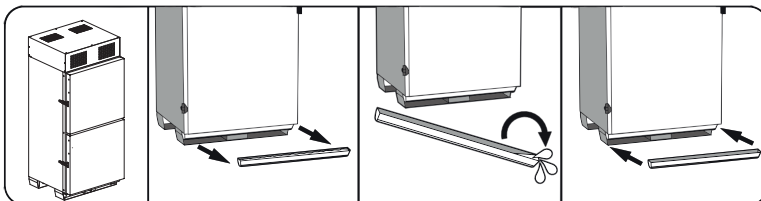

WATER PACK FREEZING INSTRUCTION

Remove insulation block holders from ice pack freezing compartment (centre and from water pack storage compartments (left and right).

- Insert/Load 4 water packs with clean water in water pack freezing compartment.
- After 24 hours, remove all water packs (now frozen) from water pack freezing compartment and load them into adjacent water pack storage compartment and load freshwater packs (4 Nos) into water pack freezing compartment.
- Repeat step 3 until the water pack storage compartment is completely loaded, i.e., 20 frozen water packs loaded in water pack storage compartment and 4 water packs in water pack freezing compartment. It will take 6 days to freeze 24 water packs.
- Make sure that after loading water packs in the freezer compartment and water pack storage compartment, the insulation block holders are kept at their respective positions.

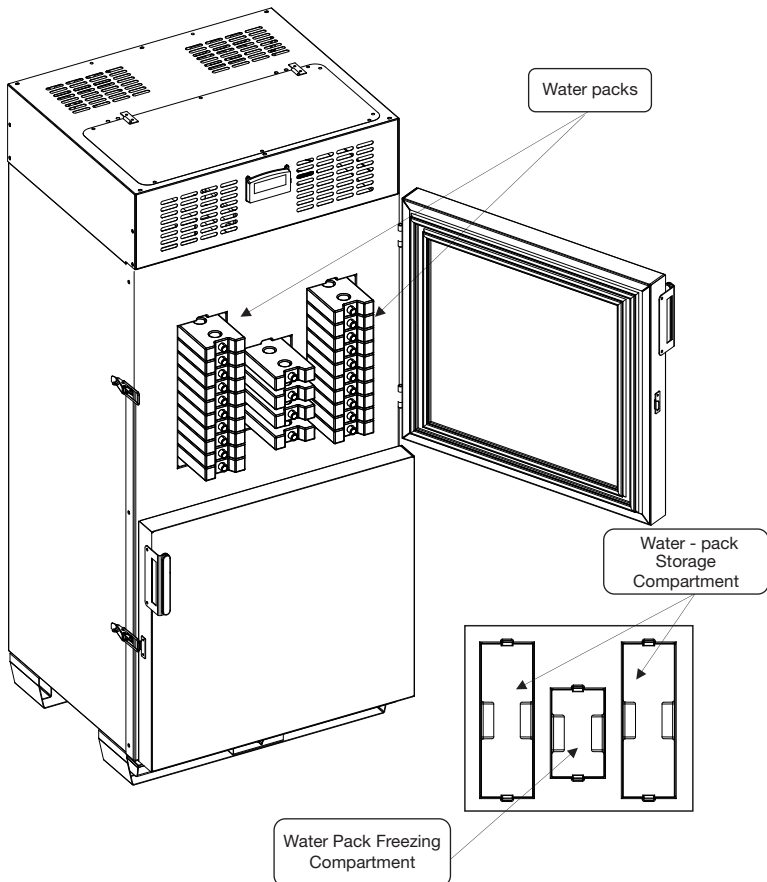

USER MAINTENANCE

Daily

1. Check compartment temperature is between 2°C and 8°C.
2. Check all vents on top of the refrigerator are unobstructed.

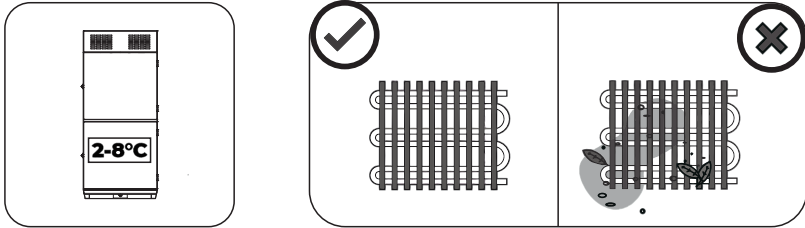

Weekly

1. Wipe clean the outside of the refrigerator with a soft cloth – do not use abrasive or scouring materials.
2. Ensure the door seals are always clean and free from obstruction, distortion or damage.
3. Check for build-up of condensation – empty drip tray and wipe the internal surfaces with a clean, dry cloth if necessary.

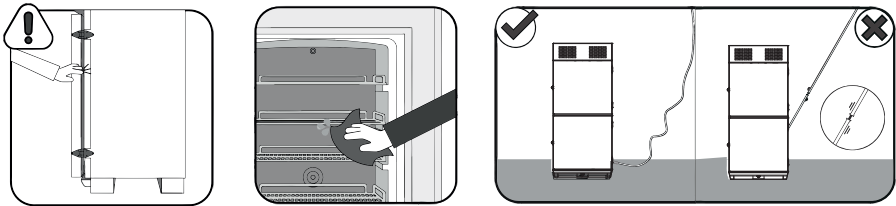

Monthly

1. Check that the condenser is clean, and air is free to move over condenser/compressor assembly. Do not remove the top cover. If there is a lot of dust around the condenser then temporarily remove the power plug and use a plastic tube to blow through the ventilation slots to clear the dust.
2. Check that the electrical cable hangs free and is not damaged.

Please contact maintenance technician immediately if appliance is not functioning correctly.

OPERATING INSTRUCTIONS

Installation must be carried out by competent technicians.

You will need

- ✓ Clean water containers (5 –20 litres), to hold...
- ✓ Clean, drinking water
- ✓ Cross head (Pozidrive) screwdriver (provided)
- ✓ Tape measure or ruler
- ✓ Funnel (provided)
- ✓ Spirit level
- ✓ Packing material for leveling the refrigerator
- ✓ Pry bar to unpack refrigerator
- ✓ Multimeter

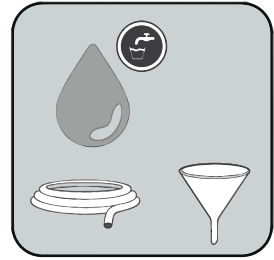

Transport and Handling

- Never try to transport the fridge when full of water or vaccine.
- Keep the refrigerator vertical, and never tilt it further than 30 degrees from vertical.
- Keep the door and latches closed when moving the refrigerator.
- Allow 24 hours after transportation before starting the compressor.
- Moving the appliance requires at least two people – follow manual handling advice.

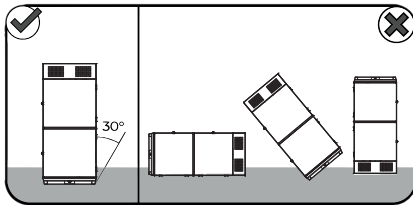

Positioning

- Position the unit with free air all around – keep all faces at least 100mm away from walls.
- Position the unit in the shade and ensure it is NEVER in direct sunlight.
- In order to remove the top cover, to fill and undertake maintenance work it is necessary to have a clearance of at least 300mm from the top of the unit. Ideally there should be 500mm+ clearance above the top of the unit.

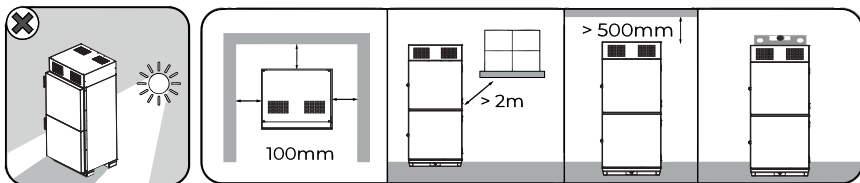

Leveling

- Ensure the unit is level and stable when in position and before filling or starting the unit.
- Check that the support bridge and condensation baffle are correctly positioned in the top of the refrigerator compartment.

Note: The baffle is designed to be loose.

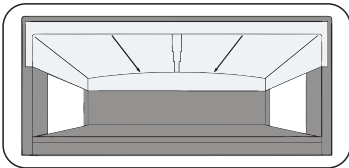

Water filling instructions

- Always check power plug is removed from the socket before removing lid and adding or removing water.
- Remove top cover of the refrigerator using screwdriver provided.
- Remove cap, fill the refrigerator tank with **162L amount of clean drinking water up to 210mm from top of pipe or as specified for that model on the label by the filling the tube.
- Good examples of drinking water would be municipal water (mains water supply), borehole water (low mineral and salt content), Reverse Osmosis (RO) water, distilled water or clean, bottled drinking water.
- The water must neither be dirty nor contaminated.
 1. Check level of water by measuring level in the fill pipe.
 2. If water level is low, add more water
 3. If water level is too high, remove some water using a hose pipe.
 4. The correct water level from the top of the pipe is 210mm.
 5. Observe safe working practices when filling the appliance.
 6. Do not overfill the unit.
 7. Replace screw cap.
 8. Mop up any spillages.

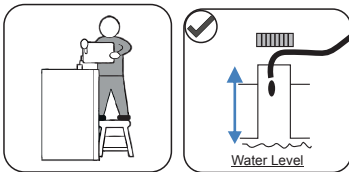

Note:

** - Water quantity mentioned is an indicative value and may vary. This is mentioned to help arrange water. Follow water level value mentioned above for filling the fridge correctly.

Switching on

- Allow 24 hours after transportation before starting the compressor.
- Check the refrigerator has been filled with water to correct level.
- Double check all the cables are secure, and the connections are tight.
- There are no parameters to set on this unit.
- The fridge controller may take 3 to 5 minutes before starting the compressor.
- Check that the door is securely closed.

Handover

- The refrigerator will take up to 6 - 8 days to cool down to operating temperature, depending on ambient temperature. It will continue building its ice store for a further 2 or 3 days.
- Do not store vaccines in the refrigerator until at least 6-8 days after commissioning.
- Users should refer to compartment thermometer/temperature recorder on appliance.
- Explain to users good operating practice, user maintenance, and what to do in the event of a fault.

Relocating the refrigerator

- Drain the water out of the refrigerator tank before transport or storage.
- Use a hose pipe to syphon the water out.

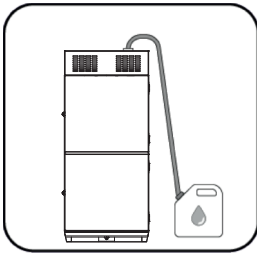

Preventative maintenance

(To be conducted by trained technicians only)

Every 6 to 12 months

1. Record site and refrigerator details.
2. Download temperature recorder.
3. Check performance from temperature record.

Environment and use

4. Confirm that the user is performing the monthly maintenance tasks and correctly using the refrigerator.
5. Check refrigerator position and ventilation and look for any signs of problems – leakages, overheating, etc.

Equipment

6. Check door hinges, locks, seals and adjust if necessary.
7. Switch the Power OFF and remove the top cover.
8. Clean condenser and other components.
9. Check fan is operating correctly.
10. Check pipe insulation.

Operation

11. Measure and record current and voltage for each compressor when running.
12. Replace and secure top cover.
13. Complete service record.





For more information, consult SureChill Standard Operating Procedure /Authorised technician.

Defrosting

This refrigerator does NOT need defrosting. SureChill Technology ensures there are never any freezing temperatures inside the vaccine compartment.

FAULT FINDING

 **These actions require a trained technician**

The compartment temperature is less than 2°C			
	Yes	No	
Is the compartment thermometer / temperature recorder correct? (Verify using another thermometer)	Go to next step	Replace the compartment thermometer/temperature recorder	
Is the appliance in ambient temperatures less than 10°C	Relocate the appliance to ambient temperature more than 10°C	Contact supplier or manufacturer	
The compartment temperature is more than 8°C			
	Yes	No	
Does the door close properly?	Go to next step.	Clean the door seal.	
		Replace the door seal. Adjust the door hinges.	
Is the compartment thermometer showing correct temperature (4- 8°C)? (Verify using another thermometer)	Go to next step.	Replace the compartment thermometer/temperature recorder.	
Are the compressors running when electricity is supplied?	Appliance may still be cooling. Remove vaccines to a safe location and recheck temperature over the next 3 days.	Go to next step.	
Are all electrical connections in place and secure?	Go to next step.	Go to next step.	
		Check all cables are secure and connected.	
Do other appliances work in the power socket?	Go to next step.	Plug the appliance in functioning power socket.	
Check the fuses in stabiliser & thermostat PCB - see details below	Go to next step.	Replace any blown fuses.	
Check electricity supply. Is the voltage within allowable tolerance? Is RED LED glowing in stabiliser PCB?	Remove vaccines to a safe location and recheck temperature over the next 3 days.	Contact supplier or manufacturer.	

Getting technical help

Before contacting a technician or the supplier for assistance, please collect the information listed below. This will make it easier to provide support.

Site and equipment

1. Location of the refrigerator
2. Name of the health facility
3. Contact name
4. Contact phone number
5. Refrigerator model (see label on back)
6. Serial number

Fault description

7. What is the problem?
8. When did it start?
9. What are the symptoms?
10. What can you hear – unusual noises, nothing, compressor/fan humming, etc?
11. What is the internal temperature?

Have you checked:

12. The door is closing properly?
13. Mains power is available at the socket?

If the refrigerator temperature has been above 8°C for more than 24 hours, have you made arrangements to move the vaccines to another cold location?

SPECIFICATIONS

TYPE/ DESCRIPTION	EXAMINATION DETAILS
Model	GVR 55 FF AC
Legal Manufacturer	Godrej & Boyce Mfg. Co. Ltd
Product type	Mains powered
Country of origin	India
Operating temperature range	+10°C to +43°C
Foaming agent	C5H10 Cyclopentane
Insulation	Polyurethane foam
External dimensions (h x w x d (cm))	182 X 79.5 X 75
Vaccine gross volume (litre)	90
Vaccine net capacity (litre)	58
Refrigerant	R600a
Refrigerant Charge (gms)	68
Capillary Diameter (mm)	0.65
Capillary Length (mm)	1372

Electrical

Voltage Stabilizer Version	Operating Voltage (VAC)	Operating Frequency (Hz)
110 V	80 - 155	60
230 V	110 - 278	50/60

Rated Current	1.1A
Max Current	1.3A

WIRING DIAGRAM

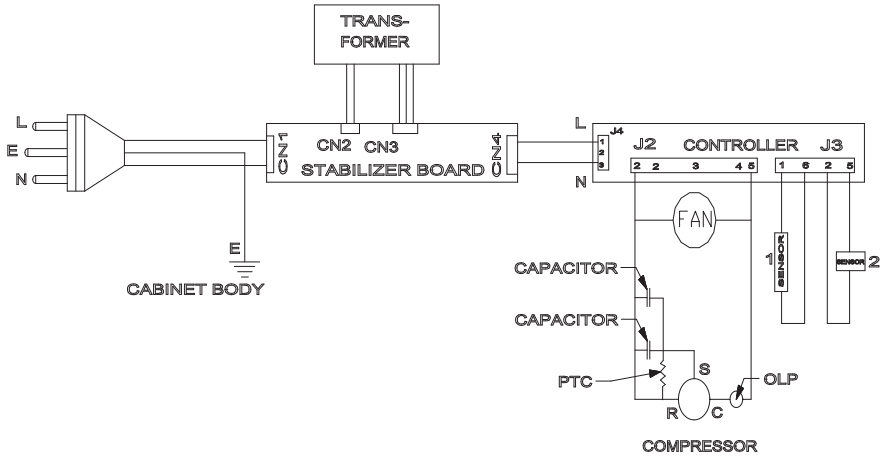

INBUILT VOLTAGE STABILIZER

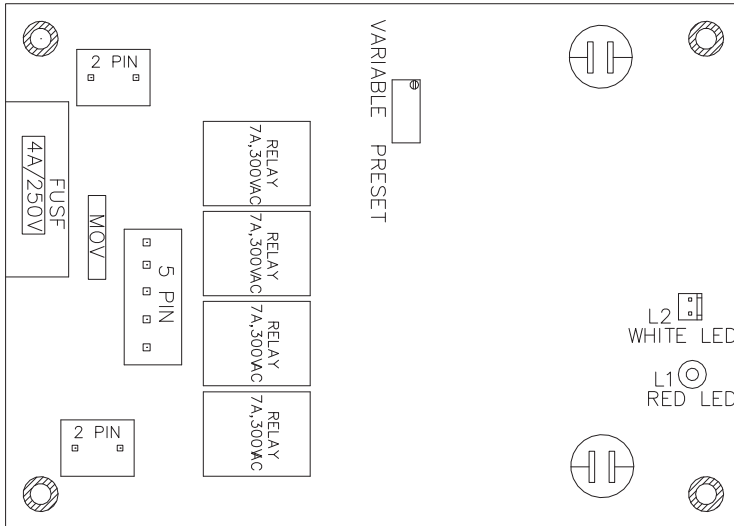

	50Hz	60Hz
Relay (Nos)	4	3
PIN (Nos)	5	4

LED INDICATION

L1 (Red)	ON: Input power present in stabiliser
L2 (Red-fitted on box side)	Flashing: Power output delay ON (180 sec Max.) Power output ON

Note: Refer electrical specification sheet

CONTROLLER PCB

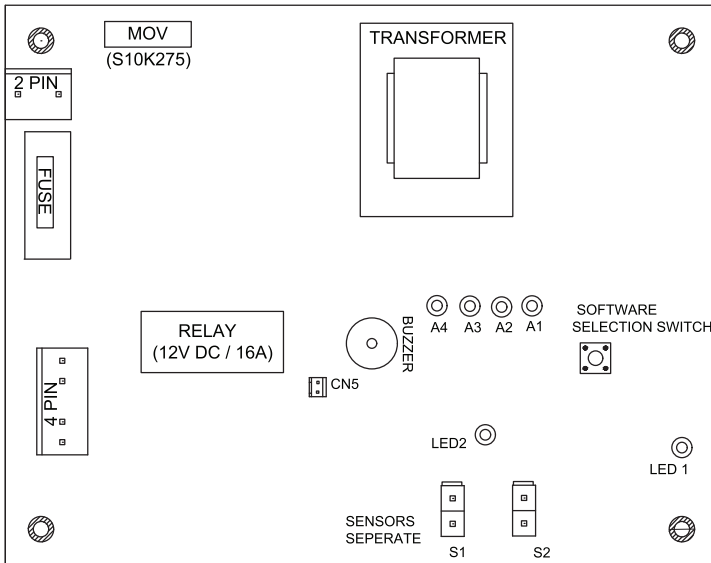

LED LOCATION	LED ON
CN5(Green – Fitted on box side)	Power ON To compressor & fan motor
LED1 (Red)	Power ON To controller
LED2 (Red & Buzzer)	If compressor ON & Temp.not achieved – Sensor fault condition

SPARE PARTS

PARTS		PART NUMBER
Electronic Thermostat		32101502SD02744
Condenser		40101704DG00049
Compressor		4015606SD00230
Capacitor		32121501SD00936
Voltage stabiliser	50hz	32101502SD00418
	60hz	32101502SD02495
Transfor mer	50hz	39121002SD00009
	60hz	39121002SD00096
Fan motor		26101114SD00378
Fan impeller		41103015PA00033
Starting relay		39122330SD00454
OLP/Protector		39122330SD00053

WARRANTY

The Medical Refrigerator is covered by a Manufacturer's Warranty from Godrej and Boyce Manufacturing Co. Ltd. Full details are provided in the Warranty Terms and Conditions, but in summary are as follows:

Duration: _____ months dated from _____.

Extent: Material or manufacturing defects that prevent normal function of the refrigerator as intended.

Limitations:

Liability is limited to the original purchase cost and excludes any consequential losses.

Remedy:

Godrej or their agents will, at their discretion, arrange for the repair or replacement of the defective appliance, either on site or at another location as appropriate.

Exclusions:

1. Accidents, negligent, improper, or inappropriate use.
2. Failure to comply with the manufacturer's instructions for installation, use, and maintenance.
3. Modifications or attempted repairs not carried out by staff authorized by Godrej or Sure Chill.
4. Actions by third parties or any other cause outside the normal operating conditions, such as fires, floods, earthquakes, and lightning (storms).
5. Damage caused by surges from the power supply.
6. Improper transport other than transport by Godrej or its agents or sub - contractors.
7. Refrigerators with serial numbers that have been manipulated and cannot be identified shall be exempt from Warranty
8. Defects due to installation if not provided by Godrej, Sure Chill or their agents.

Procedure for claim: Notify Godrej, Sure Chill or their agents within Warranty validity period of the defect, refrigerator serial number, purchase invoice number (where known), location and contact details.

Refrigeration Circuit Product Disposal WEEE Regulations

This product is covered by the European Union Waste Electrical and Electronic Equipment Regulations.

Do not dispose in landfill. Send for recycling.

Recycling information

Refrigerant:	R600a – recover and reuse
Outer casing:	Galvanized steel sheet
Foam:	Polyurethane
Foam Plastic:	Various – Contact manufacturer for advice

This product is Rohs compliant

CUSTOMER SUPPORT

Godrej & Boyce Manufacturing Company Limited, Pirojshanagar, Vikhroli West,
Mumbai – 400 079

www.godrejappliances.com/medical

Board: +91 226796 5656 / 5959

Fax: +91 226796 1700 / 1800

Email: Sales support: medicalref@godrej.com / hello@surechill.com

Service support: smartcare@godrej.com