

et Potato veg Chicken S... Leany Vegetables Idly... Jeera Rice Dal Tadka Channa Masala Bur...
et Potato Baigan Bhartha... Egg Paneer Bhurji Gaajar Halwa Milk Pudding Pizza Burger Samosa...
ada Chapati Puree Papad Fry Corn Chat Sprouts Spices Dry Fruit Onion Coconut Rawa Paneer Tikka...
g Chicken Kabab Chicken Tandoori Honey Chicken Wings Mutton Mince Balls Grilled Prawns...
ed Crabs Lobster Pizza Fish Roast Chicken Lollypops Cookies Dal Bhati Baked Fish Honey Ginger...
ic Whole Chicken Spaghetti Pasta Macaroni Noodles Steamed Jeera Rice Dal Tadka Channa Masala Bur...

Godrej | APPLIANCES

HOW TO GET THE BEST OUT OF YOUR GODREJ MICROWAVE OVEN...



User Manual

GMX-20GA8 MLM

20 ltr. Microwave Oven, Grill

g Paneer Bhurji Gaajar Halwa Milk Pudding Pizza Burger Samosa Wada Chapati Puree Papad...
y Corn Chat Sprouts Spices Dry Fruit Onion Coconut Rawa Paneer Tikka Veg Chicken Kabab...
cken Tandoori Honey Chicken Wings Mutton Mince Balls Grilled Prawns Grilled Crabs Lobster...
za Fish Roast Chicken Lollypops Cookies Dal Bhati Baked Fish Honey Ginger Garlic Whole Chicken...
ghetti Pasta Macaroni Noodles Steamed Jeera Rice Dal Tadka Channa Masala Butter...
icken Grilled Sandwich Grilled Prawns Nan Katai Veg Cutlets Popcorn Masala Peanuts...
nelette Garam Masala Roast Tadka Tea Coffee Tomato Soup Milk Hot Chocolate Veg Chicken Sto...
fy vegetables Idly Sheera Poha Sabudana kichdi Potato Beet Root Sweet Potato Baigan Bhartha...
g Paneer Bhurji Gaajar Halwa Milk Pudding Pizza Burger Samosa Wada Chapati Puree Papad...
y Corn Chat Sprouts Spices Dry Fruit Onion Coconut Rawa Paneer Tikka Veg Chicken Kabab...
cken Tandoori Honey Chicken Wings Mutton Mince Balls Grilled Prawns Grilled Crabs Lobster...
za Fish Roast Chicken Lollypops Cookies Dal Bhati Baked Fish Honey Ginger Garlic Whole Chicken...
ghetti Pasta Macaroni Noodles Steamed Jeera Rice Dal Tadka Channa Masala Butter...
icken Grilled Sandwich Grilled Prawns Nan Katai Veg Cutlets Popcorn Masala Peanuts...
nelette Garam Masala Roast Tadka Tea Coffee Tomato Soup Milk Hot Chocolate Veg Chicken Sto...
fy vegetables Idly Sheera Poha Sabudana kichdi Potato Beet Root Sweet Potato Baigan Bhartha...
g Paneer Bhurji Gaajar Halwa Milk Pudding Pizza Burger Samosa Wada Chapati Puree Papad...
y Corn Chat Sprouts Spices Dry Fruit Onion Coconut Rawa Paneer Tikka Veg Chicken Kabab...
cken Tandoori Honey Chicken Wings Mutton Mince Balls Grilled Prawns Grilled Crabs Lobster...
za Fish Roast Chicken Lollypops Cookies Dal Bhati Baked Fish Honey Ginger Garlic Whole Chicken...
ghetti Pasta Macaroni Noodles Steamed Jeera Rice Dal Tadka Channa Masala Butter...

Microwave Oven

INSTRUCTION MANUAL

Model No: GMX 20GA8 MLM

Read these instructions carefully before using your microwave oven, and keep it carefully.

If you follow the instructions, your oven will provide you with many years of good service.

SAVE THESE INSTRUCTIONS CAREFULLY

Please record the model number and serial number of this unit for future reference.

Staple your receipt here for proof of purchase.

Model No.: _____

Serial No.: _____

Dealer: _____

Dealer Phone No.: _____

TABLE CONTENT

Sr.No.	Particulars	Page No
1	Precautions & Specifications	1
2	IMPORTANT SAFETY INSTRUCTIONS	2
3	Materials to be used in Microwave Oven	5
4	Materials to be avoided in Microwave Oven & Setting up of Oven	6
5	Oven Controls	8
6	Operations	12
7	Trouble Shooting	13
8	Instacook Menu's	14
9	Warranty Details	71
10	Branch Address	72

PRECAUTIONS TO AVOID POSSIBLE EXPOSURE TO EXCESSIVE MICROWAVE ENERGY

- (a) Do not attempt to operate this oven with the door open since this can result in harmful exposure to microwave energy. It is important not to break or tamper with the safety interlocks.
- (b) Do not place any object between the oven front face and the door or allow soil or cleaner residue to accumulate on sealing surfaces.
- (c) **WARNING:** If the door or door seals are damaged, the oven must not be operated until it has been repaired by a competent person.

ADDENDUM

If the apparatus is not maintained in a good state of cleanliness, its surface could be degraded and affect the lifespan of the apparatus and lead to a dangerous situation.

Specifications

Rated Voltage	230 V ~, 50Hz,
Rated Power Input:	1000W (Grill)
	1270W (Microwave)
Rated Microwave Power Output:	800W
Operation Frequency:	2450MHz
Net Dimension (HxWxD)	24.0 cm X 43.0 cm X 32.0 cm
Turntable Diameter	255 mm
Oven Capacity:	20 Litres
Net Weight:	11.5kg

IMPORTANT SAFETY INSTRUCTIONS

READ CAREFULLY AND KEEP FOR FUTURE USE

Important Safety instructions

The Safety instructions mentioned below will tell you how to use your Microwave Oven without harming yourself and damaging your oven.

Warning – To reduce the risk of burns, electric shock, fire, injury to persons, or exposure to excessive microwave energy

- Read all the instructions before using your oven
- Do not allow children to use this oven without close supervision

Precautions to avoid possible exposure to excessive microwave energy:

- a) Do not attempt to operate this oven with the door open since open door operation can result in harmful exposure to microwave energy. It is important not to tamper with the safety interlocks.
- b) Do not place any object between the microwave oven cavity and the door or allow soil or cleaner residue to accumulate on sealing surfaces
- c) Do not operate the oven if it is damaged. It is particularly important that the oven door closes properly and that there is no damages to the:
 - i. Door (bent)
 - ii. Hinges and latches (broken or loosened)
 - iii. Door seals and sealing surfaces
- d) It is hazardous for anyone other than properly qualified competent service personnel to repair, adjust or remove the cover which gives protection against exposure to microwave energy

1. **Do not heat the following items in the microwave oven:** Whole eggs in the shell, water with oil or fat, sealed containers, or closed glass jars.

These items may explode.

- Do not cover or block any openings in the oven
- Use your oven only for the operations described in this manual
- Do not run the oven empty, without food in it
- Do not deep fry in your microwave oven
- Do not remove the turn table while using the microwave oven

- Do not make popcorn, peanuts and suji roast in plastic utensil. Use only microwaveable glass utensil.
2. Only use utensils suitable for use in microwave oven
 3. Remove wire twist-ties and metal handles from paper or plastic containers/bags before placing them in the oven
 4. The oven should be cleaned regularly and any food deposits should be removed. Failure to maintain the oven in a clean condition could lead to deterioration of the surface, and could adversely affect the life of the appliance and possibly result in a hazardous situation.
 5. When the appliance is operated in the combination mode, children should only use the oven under adult supervision due to the temperatures generated.
 6. To avoid a fire hazard do not severely overcook food. Severely overcooked foods can start a fire in the oven.
 7. When heating food in plastic or paper containers, keep an eye on the oven due to the possibility of ignition.
 8. If smoke is observed, switch off or unplug the appliance and keep the door closed in order to stifle any flames
 9. Do not use the cavity for storage purposes. Do not leave paper products, cooking utensils, or food in the cavity when not in use.
 10. Do not use this oven for commercial purposes. This appliances is intended to be used in household and similar application such as:
 - Staff Kitchen areas in shops, offices and other working environments;
 - Farm Houses;
 - By clients in hotels, motels and other residential environments;
 - Bed and breakfast type environments.
 11. When cleaning the door and the surfaces that touch the door, use only mild, non-abrasive soaps or detergents and a sponge or soft cloth
 12. Do not use corrosive chemicals or vapours, in this appliance. This type of oven is specifically designed to heat, cook, or dry food. It is not designed for industrial or laboratory use

13. Do not use or store this appliance outdoors. Do not use this product near water for example near a kitchen sink, in a wet basement, or near a swimming pool, and the likes.
14. Do not tamper with the built-in safety switches on the oven door. The oven has several built-in safety switches to make sure the power is off when the door is open.
15. If the supply cord is damaged, it must be replaced by the manufacturer, its service agent or similarly qualified persons in order to avoid a hazard
16. If your oven is dropped or damaged, have it thoroughly checked by a qualified service technician before using it again
17. The temperature of accessible surfaces may be high when the appliance is operating. Keep cord away from heated surface, and do not cover the oven.
18. Do not immerse the electrical cord or plug in water
19. Pierce food with heavy skin such as potatoes, whole squashes, apples, tomatoes, brinjals, mutton, chicken before cooking
20. Cooking utensils may become hot because of heat transferred from heated food. Potholders may be needed to handle the utensils. Utensils should be checked to ensure that they are suitable for use in microwave ovens.
21. The microwave oven shall not be placed in a cabinet
22. Liquids, such as water, coffee, or tea can be overheated beyond the boiling point without appearing to be boiling. Visible bubbling or boiling when the container is removed from the microwave oven is not always present. **THIS COULD RESULT IN VERY HOT LIQUIDS SUDDENLY BOILING OVER WHEN THE CONTAINER IS DISTURBED OR A SPOON OR OTHER UTENSIL IS INSERTED INTO THE LIQUID.**
23. To reduce the risk of injury to persons:
 - Do not overheat the liquid
 - Stir the liquid both before and halfway through heating it
 - While cooking or reheating in microwave mode, ensure the vent of the lid is kept open at all times or the lid is partially open
 - After heating, allow the container to stand in the microwave oven for a short time before removing the container
 - Use extreme care when inserting a spoon or other utensil into the container
24. The contents of feeding bottles and baby food jars shall be stirred or shaken and the temperature checked before consumption, in order to avoid burns
25. The appliances is not intended for use by persons (including children) with reduced physical, sensory or mental capabilities, or lack of experience and knowledge, unless they have been given supervision or instruction concerning use of the appliance by a person responsible for their safety
26. The rear surface of the appliance shall be placed against the wall
27. Microwave oven is intended for heating food and beverages. Drying of food or clothing and heating of warming pads, slippers, sponges, damp cloth and similar may lead to risk of injury, ignition or fire.
28. Microwave heating of beverages can result in delayed eruptive boiling, therefore care must be taken when handling the container.
29. Details for cleaning door seals, cavities and adjacent parts are given on page **CLEANING AND CARE.**
30. No temperature sensing probe to be inserted into the food placed inside the cavity of this oven by user, during switched ON state.
A temperature probe may be placed on the food once the food is taken outside the oven.
31. The microwave is intended to be used freestanding.

To Reduce the Risk of Injury to Persons

Grounding Installation

DANGER

Electric Shock Hazard
Touching some of the internal components can cause serious personal injury or death. Do not disassemble this appliance.

WARNING

Electric Shock Hazard
Improper use of the grounding can result in electric shock. Do not plug into an outlet until appliance is properly installed and grounded.

CLEANING

Be sure to unplug the appliance from the power supply.

1. Clean the inside of the oven after using with a slightly damp cloth.
2. Clean the accessories in the usual way in soapy water.
3. The door frame and seal and neighbouring parts must be cleaned carefully with a damp cloth when they are dirty.

Three-round-pin plug

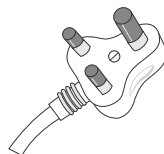

This appliance must be grounded. In the event of an electrical short circuit, grounding reduces the risk of electric shock by providing an escape wire for the electric current. This appliance is equipped with a cord having a grounding wire with a grounding plug. The plug must be plugged into an outlet that is properly installed and grounded.

Consult a qualified electrician or serviceman if the grounding instructions are not completely understood or if doubt exists as to whether the appliance is properly grounded. If it is necessary to use an extension cord, use only a 3-wire extension cord.

1. A short power-supply cord is provided to reduce the risks resulting from becoming entangled in or tripping over a longer cord.
2. If a long cord set or extension cord is used:
 - 1)The marked electrical rating of the cord set or extension cord should be at least as great as the electrical rating of the appliance.
 - 2)The extension cord must be a grounding type 3-wire cord.
 - 3)The long cord should be arranged so that it will not drape over the counter top or tabletop where it can be pulled on by children or tripped over unintentionally.

CAUTION

Personal Injury Hazard

It is hazardous for anyone other than a competent person to carry out any service or repair operation that involves the removal of a cover which gives protection against exposure to microwave energy.

UTENSILS

See the instructions on "Materials you can use in microwave oven or to be avoided in microwave oven." There may be certain non-metalic utensils that are not safe to use for microwaving. If in doubt, you can test the utensil in question following the procedure below.

Utensil Test:

1. Fill a microwave-safe container with 1 cup of cold water (250ml) along with the utensil in question.
2. Cook on maximum power for 1 minute.
3. Carefully feel the utensil. If the empty utensil is warm, do not use it for microwave cooking.
4. Do not exceed 1 minute cooking time.

Materials you can use in microwave oven

Utensils	Remarks
Aluminum foil	Shielding only. Small smooth pieces can be used to cover thin parts of meat or poultry to prevent overcooking. Arcing can occur if foil is too close to oven walls. The foil should be at least 2.5cm away from oven walls.
Browning dish	Follow manufacturer's instructions. The bottom of browning dish must be at least 5mm above the turntable. Incorrect usage may cause the turntable to break.
Dinnerware	Microwave-safe only. Follow manufacturer's instructions. Do not use cracked or chipped dishes.
Glass jars	Always remove lid. Use only to heat food until just warm. Most glass jars are not heat resistant and may break.
Glassware	Heat-resistant oven glassware only. Make sure there is no metallic trim. Do not use cracked or chipped dishes.
Oven cooking bags	Follow manufacturer's instructions. Do not close with metal tie. Make slits to allow steam to escape.
Paper plates & cups	Use for short-term cooking/warming only. Do not leave oven unattended while cooking.
Paper towels	Use to cover food for reheating and absorbing fat. Use with supervision for a short-term cooking only.
Parchment paper	Use as a cover to prevent splattering or a wrap for steaming.
Plastic	Microwave-safe only. Follow the manufacturer's instructions. Should be labeled "Microwave Safe". Some plastic containers soften, as the food inside gets hot. "Boiling bags" and tightly closed plastic bags should be slit, pierced or vented as directed by package.
Plastic wrap	Microwave-safe only. Use to cover food during cooking to retain moisture. Do not allow plastic wrap to touch food.
Thermometers	Microwave-safe only (meat and candy thermometers).
Wax paper	Use as a cover to prevent splattering and retain moisture.

Materials to be avoided in microwave oven

Utensils	Remarks
Aluminum tray	May cause arcing. Transfer food into microwave-safe dish.
Food carton with metal handle	May cause arcing. Transfer food into microwave-safe dish.
Metal or metal-trimmed utensils	Metal shields the food from microwave energy. Metal trim may cause arcing.
Metal twist ties	May cause arcing and could cause a fire in the oven.
Paper bags	May cause a fire in the oven.
Plastic foam	Plastic foam may melt or contaminate the liquid inside when exposed to high temperature.
Wood	Wood will dry out when used in the microwave oven and may split or crack.

SETTING UP YOUR OVEN

Names of Oven Parts and Accessories

Remove the oven and all materials from the carton and oven cavity.

Your oven comes with the following accessories:

- Glass tray 1
- Turntable ring assembly 1
- Instruction Manual 1

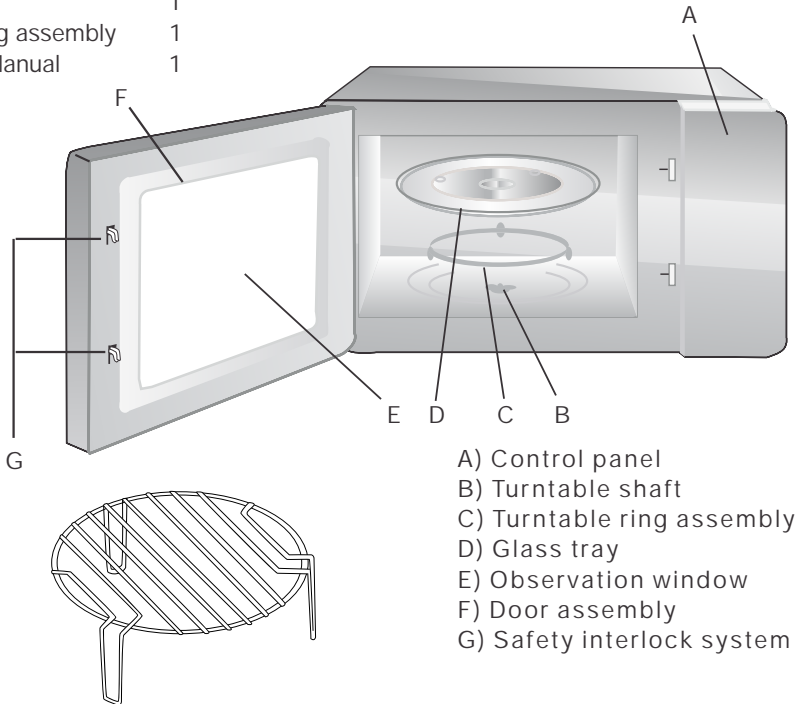

- A) Control panel
- B) Turntable shaft
- C) Turntable ring assembly
- D) Glass tray
- E) Observation window
- F) Door assembly
- G) Safety interlock system

Grill Rack (Only for Grill series)

Shut off oven power if the door is opened during operation

Turntable Installation

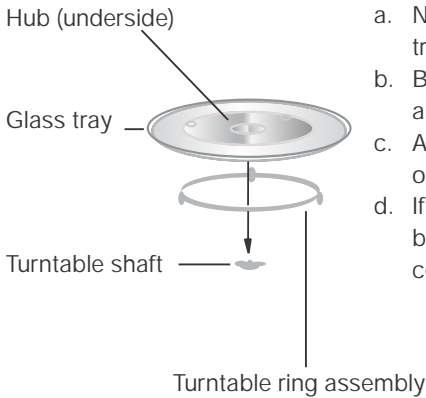

- Never place the glass tray upside down. The glass tray should never be restricted.
- Both glass tray and turntable ring assembly must always be used during cooking.
- All food and containers of food are always placed on the glass tray for cooking.
- If glass tray or turntable ring assembly cracks or breaks, contact your nearest authorised service center.

Countertop Installation

Remove all packing material and accessories. Examine the oven for any damage such as dents or broken door. Do not install if oven is damaged.

Cabinet: Remove any protective film found on the microwave oven cabinet surface. Do not remove the light brown Mica cover that is attached to the oven cavity to protect the magnetron.

Installation

1. Select a level surface that provide enough open space for the intake and/or outlet vents.

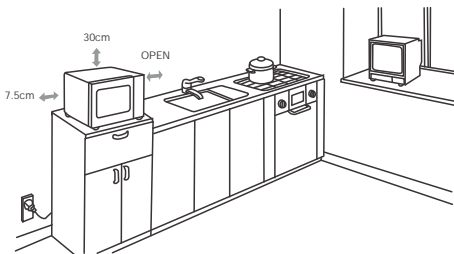

The rear surface of appliance shall be placed against a wall.

A minimum clearance of 3.0 inches (7.5cm) is required between the oven and any adjacent walls. One side must be open.

- (1) Leave a minimum clearance of 12 inches (30cm) above the oven.
- (2) Do not remove the legs from the bottom of the oven.

- (3) Blocking the intake and/or outlet openings can damage the oven.
- (4) Place the oven as far away from radios and TV as possible. Operation of microwave oven may cause interference to your radio or TV reception.
2. Plug your oven into a standard household outlet. Be sure the voltage and the frequency is the same as the voltage and the frequency on the rating label.

WARNING: Do not install oven over a range cooktop or other heat-producing appliance. If installed near or over a heat source, the oven could be damaged and the warranty would be void.

The accessible surface may be hot during operation.





Oven Controls

This microwave oven uses modern electronic control to adjust cooking parameters to meet your needs better for cooking.



1. Clock Setting

When the microwave oven is electrified, the oven will display "0:00", buzzer will ring once.

- 1) Press "CLOCK/PRE-SET", the hour figure will flash;
- 2) Turn "  " to adjust the hour figures, the input time should be within 0--23.
- 3) Press "CLOCK/PRE-SET", the minute figures will flash.
- 4) Turn "  " to adjust the minute figures, the input time should be within 0--59.
- 5) Press "CLOCK/PRE-SET" to finish clock setting. ":" will flash.

Note: 1) If the clock is not set, the clock would not function when powered.
2) During the process of clock setting, if no operation in 1 minute, the oven will go back to the previous status automatically.

2. Microwave Cooking

- 1) Press the "Micro/Grill/Combi" key once, and "P100" display.
- 2) Press "Micro/Grill/Combi" for times or turn "  " to select the microwave power "P100", "P80", "P50", "P30", "P10" will display in order.
- 3) Press "START/+30SEC./CONFIRM" to confirm.
- 4) Turn "  " to adjust the cooking time. (The time setting should be 0:05- 95:00.)
- 5) Press "START/+30SEC./CONFIRM" to start cooking.



NOTE: the step quantities for the adjustment time of the coding switch are as follow:

0---1 min: 5 seconds
0---5 min: 10 seconds
5---10 min: 30 seconds
10---30 min: 1 minute
30---95 min: 5 minutes

Microwave Power Chart



Microwave Power	100%	80%	50%	30%	10%
Display	P100	P80	P50	P30	P10

3. Grill Cooking

- 1) Press the "Micro/Grill/Combi" key once, and "P100" displays.
- 2) Press "Micro/Grill/Combi" for times or turn "  " to select the grill power.
- 3) Press "START/+30SEC./CONFIRM" to confirm when the LED displays "G".
- 4) Turn "  " to adjust the grill time. (The time setting should be 0:05- 95:00.)
- 5) Press "START/+30SEC./CONFIRM" to start cooking.

Note: If half the grill time passes, the oven sounds twice, and this is normal. In order to have a better effect of grilling food, you should turn the food over, close the door, and then press "START/+30 SEC./CONFIRM" to continue cooking. If no operation, it will continue working.

4. Combination Cooking

- 1) Press the "Micro/Grill/Combi" key once, and "P100" displays.
- 2) Press "Micro/Grill/Combi" for times or turn " " to select the combination power "C-1(55%microwave+45%grill)" and "C-2(36%microwave+64%grill)" will display in order.
- 3) Press "START/+30SEC./CONFIRM" to confirm.
- 4) Turn " " to adjust the cooking time. (The time setting should be 0:05- 95:00.)
- 5) Press "START/+30SEC./CONFIRM" to start cooking.

5. Speedy Cooking

- 1) In waiting state, press "START/+30SEC./CONFIRM" key to cook with 100% power level for 30 seconds. Each press on the same key can increase 30 seconds. The maximum cooking time is 95 minutes.
- 2) During the microwave,grill and combination cooking and time defrost process, press "START/+30SEC./CONFIRM" to increase the cooking time.
- 3) In waiting state, turn " " left to choose the cooking time directly. After choosing the time, press "START/+30SEC./CONFIRM" to start cooking. The microwave power is 100%.

Note: Under the states of auto menu and weight defrost, cooking time cannot be increased by pressing "START/+30SEC./CONFIRM"

6. Defrost By Weight

- 1) Press "W.T./TIME DEFROST" once, the screen will display "dEF1".
- 2) Turn " " to select the food weight. The range of weight is 100-2000g.
- 3) Press "START/+30SEC./CONFIRM" key to start defrosting



7. Defrost By Time

- 1) Press "W.T./TIME DEFROST" twice, the screen will display "dEF2".
- 2) Turn " " to select the cooking time. The MAX.time is 95 minutes.
- 3) Press "START/+30SEC./CONFIRM" key to start defrosting

8. Multi-Stage Cooking

Two stages can be maximumly set. If one stage is defrosting, it should be put in the first stage. The buzzer will ring once after each stage and the next stage will begin.

Note: Auto menu cannot be set as one of the multi-stage.
Example: if you want to defrost the food for 5 minutes, then to cook with 80% microwave power for 7 minutes. The steps are as following:

- 1) Press "W.T./TIME DEFROST" twice, the screen will display "dEF2";
- 2) Turn " " to adjust the defrost time of 5 minutes;
- 3) Press "Micro./Grill/Combi" once;
- 4) Turn " " to choose 80% microwave power till "P80" displays;
- 5) Press "START/+30SEC./CONFIRM" to confirm;
- 6) Turn " " to adjust the cooking time of 7 minutes;
- 7) Press "START/+30SEC./CONFIRM" to start cooking.

9. Pre-set Function

1) Set the clock first. (Consult the instruction of clock setting.)

2) Input the cooking program. Two stages can be set at most. Defrosting should not be set in preset function.

Example: if you want to cook with 80% microwave power for 7 minutes.

a. Press "Micro/Grill/Combi" once;

b. Turn "  " to choose 80% microwave power till "P80" displays;

c. Press "START/+30SEC./CONFIRM" to confirm;

d. Turn "  " to adjust the cooking time of 7 minutes;

After the above steps, please do not press "START/+30SEC./CONFIRM". Then do as following:

3) Press "CLOCK/PRE-SET". The hour figures flash;

4) Turn "  " to adjust the hour figures, the input time should be within 0--23.

5) Press "CLOCK/PRE-SET", the minute figures will flash.

6) Turn "  " to adjust the minute figures, the input time should be within 0--59.

7) Press "START/+30SEC./CONFIRM" to finish setting. ":" will light, buzzer will ring twice when the time arrives, then cooking will start automatically.

Note: clock must be set first. Otherwise, pre-set function will not work.

10. Auto Menu

1) In waiting state, turn "  " right to choose the menu from A-1 to A-8.

2) Press "START/+30SEC./CONFIRM" to confirm the menu you choose;

3) Turn "  " to choose the food weight;

4) Press "START/+30SEC./CONFIRM" to start cooking;

5) After cooking finishes, the buzzer sounds five times.

11. Lock-out Function for Children

Lock: In waiting state, press "STOP/CLEAR" for 3 seconds, there will be a long "beep" denoting entering the children-lock state and screen will display " **⏏**".

Unlocking: In locked state, press "STOP/CLEAR" for 3 seconds, there will be a long "beep" denoting that the lock is released.

12. Inquiring Function

1) In cooking states of microwave, grill and combination, press "Micro/Grill/Combi", the current power will be displayed for 2-3 seconds.

2) In pre-set state, press "CLOCK/PRE-SET" to inquire the time for delay start cooking.

The pre-set time will flash for 2-3 seconds, then the oven will turn back to the clock display.

3) During cooking state, press "CLOCK/PRE-SET" to check the current time. It will be displayed for 2-3 seconds.

13. Specification

1) The buzzer will sound once when turning the knob at the beginning;

2) "START/+30SEC./CONFIRM" must be pressed to continue cooking if the door is opened during cooking;

3) Once the cooking programme has been set, "START/+30SEC./CONFIRM" is not pressed in 1 minute. The current time will be displayed. The setting will be cancelled.

4) The buzzer sounds once by efficient press, inefficient press will be no response.

5) The buzzer will sound five times to remind you when cooking is finished

OPERATION

Control Panel and Features Operation Instructions

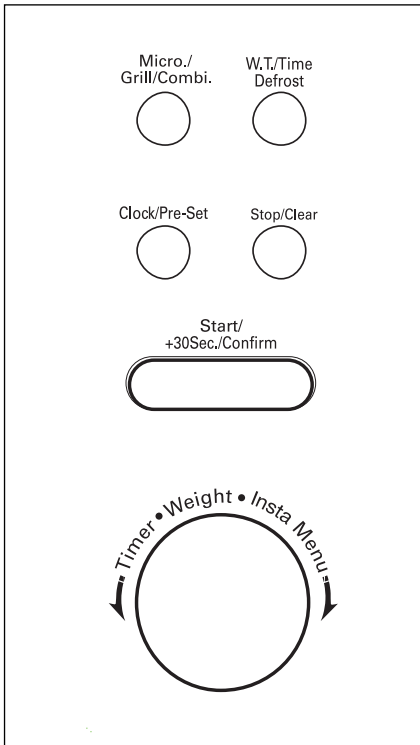

1. To set cooking power by turning the power knob to desired level.
2. To set the time of cooking by turning the timer knob to desired time per your food cooking guide.
3. The microwave oven will automatically start cooking after power level and time are set.
4. After the cooking time is up, the unit will give a bell sound
5. If the unit is not in use, always set time to "0".

Notice: When removing food from the oven, please ensure that the oven power is switched off by turning the timer switch to 0 (zero). Failure to do so, and operating the microwave oven without food in it, can result in overheating and damage to the magnetron.

Trouble shooting

Normal	
Microwave oven interfering TV reception	Radio and TV reception may be interfered when microwave oven operating. It is similar to the interference of small electrical appliances, like mixer, vacuum cleaner, and electric fan. It is normal.
Dim oven light	In low power microwave cooking, oven light may become dim. It is normal.
Steam accumulating on door, hot air out of vents	In cooking, steam may come out of food. Most will get out from vents. But some may accumulate on cool place like oven door. It is normal.
Oven started accidentally with no food in.	It is forbidden to run the unit without any food inside. It is very dangerous.

Trouble	Possible Cause	Remedy
Oven cannot be started.	(1) Power cord not plugged in tightly.	Unplug. Then plug again after 10 seconds.
	(2) Fuse blowing or circuit breaker works.	Replace fuse or reset circuit breaker (repaired by professional personnel of our company)
	(3) Trouble with outlet.	Test outlet with other electrical appliances.
Oven does not heat.	(4) Door not closed well.	Close door well.
Glass turntable makes noise when microwave oven operates	(5) Dirty roller rest and oven bottom.	Refer to "Maintenance of Microwave" to clean dirty parts.

INSTA MENU'S

For food or the following cooking mode, it is not necessary to program the duration and the cooking power. It is sufficient to indicate the type of food that you wish to cook as well as the weight of this food.

Note: To select a specific recipe from those given below, identify the InstaCook menu it falls under (Insta1, Insta2, etc), rotate the jog dial in the anti clockwise direction and select the relevant Insta menu. The InstaCook menu will be displayed as A1, A2,A8.

InstaCook Recipes

TEA	Insta 1	TEA	200g	400g	600g
		Ingredients;			
		tea	1½ tsp	2 tsp	3 tsp
		milk	2 cups	3 cups	4 cups
		sugar to taste			
		water as required			
		Method of preparation:			
		Take a microwave oven safe large bowl, add water, milk, sugar, tea, mix well and place the bowl in microwave oven, select Insta 1, enter weight, press start.			

OMLETTE	Insta 1	OMLETTE	200g	400g	600g
		Ingredients:			
		eggs - beaten	2	3	4
		onion - finely chopped	1	1	2
		green chillies - finely chopped	1	2	2
		red chilli powder	½ tsp	½ tsp	1 tsp
		oil as required			
		coriander leaves for garnish			
		salt To Taste			
		Method of preparation;			
		Prepare tadka in a microwave oven safe flat bowl as explained in Insta 2 with all the ingredients other than egg and coriander leaves. Remove, add the beaten eggs, but not the coriander leaves and mix well. Place the bowl in the microwave oven, select Insta 1, enter weight and press start. remove garnish with coriander leaves and serve hot			

CORN CHAT	Insta 1	CORN CHAT	200 g	400 g	600 g
		Ingredients:			
		sweat corn kernels	¾ cup	1 cup	1¼ cup
		tomato chopped to small pieces	¾ cup	1 cup	1¼ cup
		cooked potato cut into pieces	¾ cup	1 cup	1¼ cup
		cucumber cut into small pieces	¾ cup	1 cup	1¼ cup
		chopped coriander	½ tbsp	1 tbsp	1 tbsp
		lime juice	½ tsp	¾ tsp	¾ tsp
		chat masala	1½ tsp	2 tsp	2 tsp
		cumins powder	1 tsp	1½ tsp	1½ tsp
		red chilli powder	1 tsp	1 tsp	1½ tsp
		salt to taste			
		Method of preparation			
		Take a microwave oven safe bowl, add sweet corn, tomatoes, chat masala, cumins powder, red chilli powder, salt, mix well and select Insta 1, enter weight and press start. Remove and serve hot.			

ROTI CHIWDA	Insta 1	ROTI CHIWDA	200g	400g	600g
		Ingredients:			
		roti (break into small pieces)	1 cup	1½ cup	2 cup
		green peas	1 tbsp	1½ tbsp	1½ tbsp
		carrot (chopped)	1 tbsp	1½ tbsp	1½ tbsp
		channa dhal	1 tsp	1½ tsp	1½ tsp
		urad dhal	1 tsp	1½ tsp	1½ tsp
		onions (chopped)	1	1	2
		green chilli (small chopped)	2	3	3
		turmeric powder	¼ tsp	¼ tsp	½ tsp
		cumin seeds	½ tsp	1 tsp	1tsp
		salt to taste			
		oil as required			
		grated coconut for garnish;			
		fresh coriander for garnish;			
Method of preparation;					
<p>Prepare tadka as explained in Insta 2 in a microwave oven safe bowl with all the ingredients other than small pieces of roti, salt, sugar and lime. Remove; add the remaining ingredients and mix well. Cover the bowl with lid and place it in the microwave oven. select Insta 1, enter weight and press start. garnish with coconut and fresh coriander, serve hot</p>					

VEGETABLE CHAT	Insta 1	VEGETABLE CHAT	200g	400g	600g
		Ingredients:			
		sev	40 gms	80 gms	120 gms
		peanuts - roasted & crushed	40 gms	80 gms	120 gms
		boiled potato - diced into small cubes	40 gms	80 gms	120 gms
		chick peas (Kabuli channa) - Boiled (optional)	40 gms	80 gms	120 gms
		corn kernel - Boiled	40 gms	80 gms	120 gms
		onion - chopped finely	½	1	1
		green chilli - chopped finely	1	2	2
		tomato - chopped finely	½	½	1
		fresh coriander leaves - chopped	½ tbsp	½ tbsp	1 tbsp
		chaat masala powder (optional)	1 tsp	1 tsp	1½ tsp
		red chilli powder	½ tsp	½ tsp	1 tsp
		lemon juice	½ tsp	1 tsp	1 tsp
		tamarind chutney	½ tbsp	½ tbsp	1 tbsp
		salt to taste			
Method of preparation:					
<p>Take a Microwave oven safe bowl, combine all the ingredients, mix well, keep bowl on the turn table and select Insta 1, enter weight, press start. Remove and serve.</p>					

TOMATO PUREE	Insta 1	TOMATO PUREE	200g	400g	600g
		Ingredients;			
		tomatoes	200g	400g	600g
		Method of preparation:			
Take a microwave oven safe bowl, add tomatoes, and place the bowl in the microwave oven. Select Insta 1, set weight and press start. Set a side to cool, remove the top cover, smash and serve.					

CASHEW ROAST	Insta 1	CASHEW ROAST	200g	400g	600g
		Ingredients;			
		cashew nuts	200g	400g	600g
		Method of preparation			
Take a microwave oven safe bowl, add cashew nuts, place the bowl in microwave oven and select Insta 1, enter weight and press start.					

COCONUT ROAST	Insta 1	COCONUT ROAST	200g	400g	600g
		Ingredients;			
		grated coconut	200g	400g	600g
		Method of preparation:			
Take a microwave oven safe glass bowl, add grated coconut, place the bowl in the microwave oven. select Insta 1, enter weight, press start. stir once in between.					

FENNEL (saunf) ROAST	Insta 1	FENNEL (saunf) ROAST	200g	400g	600g
		Ingredients;			
		fennel seeds	200g	400g	600g
		Method of preparation			
Take a microwave oven safe glass bowl, add fennel, place the bowl in microwave oven and select Insta 1, enter weight and press start.					

TAMARIND PULP	Insta 1	TAMARIND PULP	200g	400g	600g
		Ingredients:			
		tamarind	200g	400g	600g
		water as required			
		Method of preparation:			
Take a microwave oven safe bowl, add tamarind and water, keep aside for some time. Place the bowl on the turn table in the microwave oven, select Insta 1, enter weight & press start. Remove, and smash the tamarind smoothly to make pulp.					

Tadka/ vagar/ talimpu	Insta 2	Tadka/ Vagar/ Talimpu	200g	300g	400g
		Ingredients:			
		oil / ghee as required			
		Green chillies	2	3	3
		chopped onions	2	2	3
		jeera	¼ tsp	1 tsp	1¾ tsp
		garlic	¼ tsp	1 tsp	1¾ tsp
		ginger	¼ tsp	1 tsp	1¾ tsp
		hing	a pinch	a pinch	a pinch
		Mustard seeds	¼ tsp	1 tsp	1 tsp
		turmeric powder	¼ tsp	½ tsp	½ tsp
		red chilli powder	1 tsp	1½ tsp	2 tsp
		curry leaves	few	few	few
		cinnamon	2	2	3
		cardamom	3	4	4
		bay leaves	few	few	few
		coriander	few	few	few
		cloves	3	4	4
		pepper corns	few	few	few
Method of preparation					
Take a microwave oven safe bowl, add any ingredients according to the recipe, mix well select Insta cook 2, enter weight, press start.					

POHA	Insta 2	POHA	200g	300g	400g
		Ingredients:			
		poha	1 cup	2 cup	2½ cup
		green peas	1 tbsp	1½ tbsp	1½ tbsp
		carrot (chopped)	1 tbsp	1½ tbsp	1½ tbsp
		channa dhal	1 tsp	1½ tsp	1½ tsp
		urad dhal	1 tsp	1½ tsp	1½ tsp
		onions (chopped)	1	1	2
		green chilli (small chopped)	2	3	3
		turmeric powder	¼ tsp	¼ tsp	½ tsp
		cumin seeds	½ tsp	1 tsp	1tsp
		salt to taste			
		oil as required			
		grated coconut for garnish;			
		fresh coriander for garnish;			
		Method of preparation;			
		Prepare tadka as explained in Insta 2 in a microwave oven safe bowl with all the ingredients other than pohe, salt, sugar and lime. Remove; add the remaining ingredients and mix well. Cover the bowl with lid and place it in the microwave oven. Select Insta 2, enter weight and press start. Garnish with grated coconut & fresh coriander, serve hot.			

STIR FRIED OATS	Insta 2	STIR FRIED OATS	200g	300g	400g
		Ingredients:			
		oats	200g	300g	400g
		raisins	few	few	few
		flour	½ tbsp	1 tbsp	1 tbsp
		cinnamon	1 stick	2 stick	3 stick
		sugar	1 tsp	1½ tsp	2 tsp
		butter as required			
		salt to taste			
		Method of preparation;			
		Prepare tadka in a microwave oven safe bowl as explained in Insta 2 with all the ingredients other than raisins and flour. After beep, remove, add the remaining ingredients and mix well. Place the bowl in the microwave oven select Insta 2, enter weight and press start.			

POP CORN	Insta 2	POP CORN	200g	300g	400g
		Ingredients:			
		pop corn	200g	300g	400g
		butter	2 tsp	2 tsp	3 tsp
		red chilli powder (optional)	½ tsp	1 tsp	1½ tsp
		turmeric powder	½ tsp	½ tsp	½ tsp
		salt to taste			
		Method of preparation			
Take a microwave oven safe large glass bowl, add all ingredients, mix well and place the bowl in the microwave oven, select Insta 2, set weight, press start. Remove and serve hot.					

BOMBIL FRY	Insta 2	BOMBIL FRY	200g	300g	400g
		Ingredients:			
		Bombay duck fish	200g	300g	400g
		ginger, garlic paste	1 tsp	1 tsp	1½ tsp
		red chilli powder	1 tsp	1 tsp	1½ tsp
		garam masala powder	¼ tbsp	½ tbsp	1 tbsp
		rice flour	1 tbsp	1½ tbsp	2 tbsp
		salt to taste			
		oil as required			
		coriander leaves for garnish			
Method of preparation:					
Marinate bombil with all ingredients other than oil and coriander leaves for 20 minutes. Take a microwave oven safe bowl, add oil and marinated bombil, mix well. Place the bowl in the microwave oven select Insta 2, enter weight and press start. Remove, garnish with coriander leaves. serve hot.					

CHICKEN STOCK	Insta 2	CHICKEN STOCK	200g	300g	400g
		Ingredients:			
		Fresh Chicken (or leftover chicken parts)	200g	300g	400g
		Carrot (peeled and roughly chopped)	1 cup	1 cup	1½ cup
		Onion (peeled and quartered)	1	2	2
		Water	½ tbsp	1 tbsp	2 tbsp
		Bay Leaf	1	2	2
		Celery (roughly chopped)	½ tbsp	1½ tbsp	1½ tbsp
		Fresh Parsley	½ tbsp	1½ tbsp	1½ tbsp
		Fresh Thyme	½ tbsp	1½ tbsp	1½ tbsp
		Peppercorns	few	few	few
		Salt to taste			
		Method of preparation			
Take a Microwave oven safe bowl and put the chicken, vegetables, salt, pepper corns, water, bay leaf, parsley, thyme stir and place the bowl on the turn table select Insta cook 2, enter weight, press start.					

PUMPKIN SOUP	Insta 2	PUMPKIN SOUP	200g	300g	400g
		Ingredients:			
		pumpkin	200g	300g	400g
		chopped onion	1 cup	1½ cup	2 cup
		green chillies	2	2	3
		garlic, finely chopped	½ tsp	1 tsp	1½ tsp
		curry powder	½ tsp	1 tsp	1½ tsp
		chilli powder	½ tsp	1 tsp	1½ tsp
		black pepper	½ tsp	½ tsp	½ tsp
		sugar	1 tsp	1½ tsp	2 tsp
		curry leaves	few	few	few
		chicken broth	½ cup	1 cup	1½ cup
		evaporated milk	½ cup	1 cup	1 cup
		coconut milk	½ cup	1 cup	1 cup
		butter as required			
		salt to taste			
		Method of preparation			
		Prepare tadka in a microwave oven safe bowl as explained in Insta 2 with all the ingredients other than pumpkin, chicken broth, evaporated milk and coconut milk. Remove, add the remaining ingredients and mix well. Place the bowl in the microwave oven select Insta 2, enter weight and press start.			

BREAD CHIWDA	Insta 2	BREAD CHIWDA	200g	300g	400g
		Ingredients:			
		bread slices	200g	300g	400g
		mustard seeds	¼ tsp	½ tsp	1 tsp
		cumin seeds	1 tsp	1 tsp	1½ tsp
		onion finely chopped	1	2	2
		turmeric powder	¼ tsp	¼ tsp	¼ tsp
		hing	a pinch	a pinch	a pinch
		curry leaves	few	few	few
		raw peanuts	½ tbsp	1 tbsp	1 tbsp
		oil as required			
		salt to taste			
		coriander leaves for garnish			
		Method of preparation;			
		Prepare tadka in a microwave oven safe bowl as explained in Insta 2 with all the ingredients other than bread slices, hing and coriander leaves. after beep, remove, add the remaining ingredients other than the coriander leaves and mix well. Place the bowl in the oven, select Insta 2, enter weight & press start. Garnish with coriander leaves, serve hot.			

MASALA PEANUTS	Insta 2	MASALA PEANUTS	200g	300g	400g
		Ingredients:			
		shelled peanuts	200g	300g	400g
		red chilli powder	1 tsp	1½ tsp	2 tsp
		soda bicarb	1 pinch	1 pinch	1 pinch
		oil	¼ tbsp	½ tbsp	1 tbsp
		plain flour	1 tbsp	1 tbsp	1½ tbsp
		rice flour	1 tbsp	1 tbsp	1½ tbsp
		chat masala	½ tsp	1 tsp	1 tsp
		salt to taste			
		Method of preparation:			
		Take oil in a microwave oven safe glass bowl, add peanuts, red chilli powder, plain flour, rice flour, soda bicarb, chat masala, salt & mix well. Make sure that the peanuts are evenly coated. Place the bowl in the microwave oven, select Insta 2, enter weight & press start. For better result stir twice in between.			

MUSHROOM MASALA	Insta 2	MUSHROOM MASALA	200g	300g	400g
		Ingredients:			
		mushrooms (sliced)	200g	300g	400g
		bread Crumbs	1 tbsp	1½ tbsp	2 tbsp
		sour Cream	¾ cup	1 cup	1 cup
		flour	½ tbsp	½ tbsp	1 tbsp
		red chilli powder	½ tsp	½ tsp	1 tsp
		lemon juice	½ tsp	½ tsp	1 tsp
		butter	½ tbsp	½ tbsp	1 tbsp
		salt to taste			
		cheese (grated) for garnish			
		Method of preparation			
		Prepare tadka in a microwave oven safe bowl as explained in Insta 2 with all the ingredients other than bread crumbs, sour cream, flour and cheese. Remove, add the remaining ingredients other than the cheese and mix well. Place the bowl in the microwave select Insta 2, enter weight and press start.			

MASHED POTATO SALAD	Insta 2	MASHED POTATO SALAD	200g	300g	400g
		Ingredients:			
		mashed potatoes	200g	300g	400g
		chopped celery	few	few	few
		onion paste	½ cup	1 cup	1½ cup
		milk	½ cup	1 cup	1½ cup
		dry mustard	¼ tsp	½ tsp	1 tsp
		green bell pepper rings	few	few	few
		pepper to taste			
		salad dressing as required			
		salt to taste			
Method of preparation;					
<p>Take a microwave oven safe bowl, add potatoes. Place the bowl in the microwave oven select Insta 2, enter weight and press start. After beep, remove and mash the potatoes with milk and onion. Prepare tadka as explained in Insta 2 with mashed potato and all ingredients, select Insta 2, enter weight & press start.</p>					

PEANUTS CHUTNEY	Insta 2	PEANUTS CHUTNEY	200g	300g	400g
		Ingredients:			
		peanuts	200g	300g	400g
		red chillies	2	2	3
		onion	1 cup	1½ cup	2 cup
		garlic	½ tsp	1 tsp	1½ tsp
		tamarind pulp	½ cup	1 cup	1 cup
		cumin	½ tsp	1 tsp	1 tsp
		curry leave	few	few	few
		mustard seeds	½ tsp	1 tsp	1 tsp
		urad dal	1 tsp	1½ tsp	1½ tsp
		salt to taste			
Method of preparation;					
<p>Take a microwave oven safe glass bowl, add peanuts and place the bowl in the microwave oven select Insta 2, enter weight and press start. After beep, remove the peanuts and rub the skins off and make a fine paste of the peanuts. Prepare tadka as explained in Insta 2 with all ingredients other than peanuts paste. Remove & add peanuts paste.</p>					

DALIYA KICHDI	Insta 2	DALIYA KICHDI	200g	300g	400g
		Ingredients:			
		dalia (broken wheat)	200g	300g	400g
		mix vegetable chopped	1 cup	1 cup	1½ cup
		onion chopped	1	1	2
		green chillies	2	2	3
		garlic, ginger paste	1 tsp	1 tsp	1½ tsp
		turmeric powder	a pinch	a pinch	a pinch
		cumin's seeds	1 tsp	1 tsp	1½ tsp
		coriander powder	1 tsp	1 tsp	1½ tsp
		oil as required			
		salt to taste			
		coriander leaves for garnish			
		Method of preparation;			
		Prepare tadka in a microwave oven safe bowl as explained in Insta 2 with all the ingredients other than dalia and coriander leaves. After beep, remove, add the remaining ingredients other than the coriander leaves and mix well. Place the bowl in the microwave oven, select Insta 2, enter weight & press start.			

PANEER PEAS CURRY	Insta 2	PANEER PEAS CURRY	200g	300g	400g
		Ingredients:			
		paneer cubes	200g	300g	400g
		green peas	1 cup	1 cup	1½ cup
		onions	1	1	2
		tomato puree	1 cup	1 cup	1½ cup
		ginger, garlic paste	½ tsp	1 tsp	1½ tsp
		coriander powder	½ tsp	1 tsp	1 tsp
		cumin powder	½ tsp	1 tsp	1 tsp
		garam masala	½ tsp	1 tsp	1 tsp
		turmeric powder	½ tsp	1 tsp	1 tsp
		green chillies chopped	2	2	3
		heavy cream	¼ cup	½ cup	½ cup
		oil as required			
		salt to taste			
		coriander leaves for garnish			
		Method of preparation;			
		Prepare tadka in a microwave oven safe bowl as explained in Insta 2 with all the ingredients other than paneer, tomato puree, heavy cream and coriander leaves. After beep, remove, add the remaining ingredients other than the coriander leaves and mix well. Place the bowl in the microwave oven select Insta 2, enter weight and press start. Remove, garnish with grated coriander and serve.			

KHANDVI	Insta 3	Ingredients:	250gms	350gms	450gms
		Besan	1 cup	1½ cup	2 cup
		Butter Milk	2 cup	3 cup	4 cup
		Turmeric Powder	¼ tsp	¼ tsp	½ tsp
		Sesame Seeds	1 tsp	1½ tsp	2 tsp
		Mustard Seeds	¼ tsp	½ tsp	½ tsp
		Coconut Scraped	½ tbsp	½ tbsp	¾tbsp
		Chopped Coriander	½ tbsp	½ tbsp	¾tbsp
		Hing	a pinch	a pinch	pinch
		Chopped Green Chillies	2	2	3
		Oil As Required			
		Salt To Taste			
		Water As Required (Optional)			
		Method of preparation;			
		Take butter milk in a microwave oven safe bowl, add besan, turmeric powder, oil, salt, sesame seeds, mustard, hing, coconut, coriander, green chillies & mix well to avoid lump formation. Place the bowl on the turn table in the microwave oven, select Insta 4, enter weight & press start. When done, pour a cup full in a large flat plate. Spread as thin as possible with the back of a large flat spoon using circular outward movements. Allow to cool & cut into 1½ inch wide strips. Carefully roll each strip & Serve with chutney.			

SAUNF LEAVES CURRY	Insta 3	SAUNF LEAVES CURRY	250gms	350gms	450gms
		Ingredients:			
		saunf leaves, Finely Chopped	250gms	350gms	450gms
		Red Chilly Powder	1 tsp	1 tsp	1½ tsp
		Moong Dal	¼ cup	½ cup	¾cup
		Garam Masala	1 tsp	1 tsp	1 tsp
		Turmeric Powder	¼ tsp	¼ tsp	½ tsp
		Garlic Paste	¼ tsp	¼ tsp	½ tsp
		Ginger Paste	¼ tsp	¼ tsp	½ tsp
		Oil As Required			
		Salt To Taste			
		Method of preparation			
		Prepare tadka in a microwave oven safe bowl as explained in Insta 2 with all the ingredients other than palak and salt. After beep, remove, add the remaining ingredients and mix well. Place the bowl in the microwave oven, select Insta 3, enter weight and press start. Remove and serve hot.			

SWEET CORN	Insta 3	SWEET CORN	250gms	350gms	450gms
		Ingredients:			
		sweet corn	250gms	350gms	450gms
Method of preparation					
keep the sweet corns on the turn table in the microwave oven, select Insta 4, enter weight and press start. Remove and serve hot.					

IDLI	Insta 3	IDLI	250gms	350gms	450gms
		Ingredients:			
		Idly Batter	250gms	350gms	450gms
Method of preparation					
Pour idly batter in lightly greased microwave safe idly stand. Pour some water in the bottom of the idly bowl and cover the bowl with lid. Place the bowl in the microwave oven, select Insta 3, enter weight & press start. Remove after beep & serve hot with sambhar and coconut chutney.					

DHOKLA	Insta 3	DHOKLA	250gms	350gms	450gms
		Ingredients:			
		Besan (Gram Flour)	1 cup	1½ cup	2 cup
		Corn Flour	1 tsp	1½ tsp	2 tsp
		Sugar	½ tsp	1 tsp	1½tsp
		Turmeric Powder	¼ tsp	¼ tsp	½ tsp
		Curd	¼ cup	½ cup	¾ cup
		Soda-Bi-Carb	¼ tsp	¼ tsp	½ tsp
		Lemon Juice	1 tsp	1½ tsp	2 tsp
		Mustard Seeds	½ tbsp	½ tbsp	¾tbsp
		Green Chillies - Finely Chopped	1 tsp	1½ tsp	2 tsp
		Salt To Taste			
		Oil As Required			
		Grated Coconut For Garnish			
		Coriander Leaves For Garnish			
		Water As Required			
		Curry Leaves For Garnish			
Method of preparation					
Take gram flour, curd, water, salt, mix well into a batter. Cover it and set aside for 4 hours to marinate. Add green chillies, turmeric, lime juice, oil, soda-bi-carb and mix into a smooth batter. Pour into microwave oven safe lightly greased bowl, place in the microwave oven, select Insta 3, enter weight, and press start. For tadka, use curry leaves, mustard seeds, oil, and green chillies. Garnish with coriander leaves and grated coconut. Serve with chutney.					

GUJARATI KADHI	Insta 3	GUJARATI KADHI	250gms	350gms	450gms
		Ingredients:			
		Curd	2 cup	2½ cup	3 cups
		Besan	4 tsp	4 tsp	5 tsp
		Green Chillies	2	2	3
		Turmeric Powder	¼ tsp	¼ tsp	¼ tsp
		Ginger Paste	½ tsp	½ tsp	¾ tsp
		Cinnamon Powder	¼ tsp	¼ tsp	¼ tsp
		Mustard Seeds	½ tsp	½ tsp	¾ tsp
		Cumin Seeds	½ tsp	½ tsp	¾ tsp
		Hing	a pinch	a pinch	a pinch
		Coriander Leaves	few	few	few
		Curry Leaves	few	few	few
		Oil As Required			
		Salt To Taste			
		Method of preparation			
		<p>Make a paste of ginger, green chillies, cinnamon and coriander leaves. In a mixing bowl, add two cups of water, curd, besan and salt and turmeric powder. Mix well. Add the paste with curd, mix well and set aside. Prepare tadka in a microwave oven safe bowl in Insta 2 with oil, mustard seeds, curry leaves, cumin's seeds and hing. After beep, remove, add the remaining ingredients and mix well. Place the bowl in the microwave oven, select Insta 3, enter weight and press start. Remove and serve hot.</p>			

SEV- BHAJI	Insta 3	SEV- BHAJI	250gms	350gms	450gms
		Ingredients:			
		sev	250gms	350gms	450gms
		tomato puree	1 tbsp	1 tbsp	1½ tbsp
		chopped onions	1	1	2
		mustard seeds	¼ tsp	½ tsp	1 tsp
		cumin seeds	¼ tsp	½ tsp	1 tsp
		green chilli	1	2	3
		hing	a pinch	a pinch	a pinch
		curry leaves	few	few	few
		turmeric powder	¼ tsp	¼ tsp	¼ tsp
		red chilli powder	1 tsp	1½ tsp	2 tsp
		ground coriander	½ tsp	½ tsp	1 tsp
		ground cumin	½ tsp	½ tsp	1 tsp
		oil as required			
		salt to taste			
		coriander leaves for garnish			
		Method of preparation;			
		<p>Prepare tadka in a microwave oven safe bowl as explained in Insta 2 with all the ingredients other than sev, tomato puree and coriander leaves. After beep, remove, add the remaining ingredients other than the coriander leave and mix well. Place the bowl in the microwave oven select Insta 3, enter weight and press start. Remove, garnish with grated coriander and serve.</p>			

HOT CHOCOLATE	Insta 3	HOT CHOCOLATE	250gms	350gms	450gms
		Ingredients:			
		condensed Milk	1½ cup	2 cup	3 cup
		sugar	¾ cup	1 cup	1½ cup
		unsweetened cocoa	1 tsp	1 tsp	2 tsp
		ground cinnamon	a pinch	a pinch	a pinch
		salt to taste			
		water as required			
		Method of preparation;			
		In a Microwave oven safe bowl, combine the condensed milk, sugar, cocoa, cinnamon and salt and water stir until milk powder is dissolved. Keep bowl on the turn table and select Instacook 3, enter weight, press start.			

MIRCHI KA SALAN	Insta 3	MIRCHI KA SALAN	250gms	350gms	450gms
		Ingredients:			
		Deep fried Green chillies	250gms	350gms	450gms
		Onion paste	1 cup	1½ cup	2 cups
		Ginger garlic paste	1tsp	1½tsp	2tsp
		Mustard seeds	1tsp	1½tsp	2tsp
		Cloves	few	few	few
		Curry leaves	few	few	few
		Tamarind pulp			
		Oil as required			
		Coriander leaves for garnish			
		Salt to taste			
		Salan Paste			
		Grated Coconut	½ cup	1 cup	1½ cup
		Roasted Peanuts	½ cup	1 cup	1½ cup
		Coriander seeds	1tsp	1½tsp	2tsp
		Sesame seeds	½ cup	1 cup	1½ cup
		Cumin seeds	1tsp	1½tsp	2tsp
		Peppercorns	few	few	few
		Red Chillies	3	4	5
		Method of preparation;			
		Prepare tadka in a microwave oven safe bowl as explained in Insta 2 with all the ingredients other than green chillies, tamarind pulp and coriander leaves. After beep, remove; add the remaining ingredients other than the coriander leaves and mix smoothly. Place the bowl in the microwave oven select Insta 3, enter weight and press start. Remove, garnish with grated coriander and serve.			

PANEER BHURJI	Insta 4	PANEER BHURJI	250gms	350gms	450gms
		Ingredients:			
		Paneer Grated	250gms	350gms	450gms
		Tomatoes	2	3	4
		Oil	½ tbsp	1 tbsp	1tbsp
		Cumin Seeds	½ tsp	1 tsp	1 tsp
		Green Chillies	3	4	4
		Onion Chopped	2	3	3
		Turmeric Powder	¼ tsp	½ tsp	½ tsp
		Garam Masala Powder	1 tsp	1½ tsp	2 tsp
		Ginger-Garlic Paste	1 tsp	1½ tsp	1½ tsp
		Salt To Taste			
		Method of preparation			
Prepare tadka in a microwave oven safe bowl as explained in Insta 2 with all the ingredients other than grated paneer and salt. After beep, remove, and add grated paneer, salt, mix well and select Insta 4, enter weight, press start. Serve hot.					

LEAFY VEGETABLE	Insta 4	LEAFY VEGETABLE	250gms	350gms	450gms
		Ingredients:			
		spinach leaves, washed & chopped	125gms	175gms	225gms
		mustard greens, washed & chopped	125gms	175gms	225gms
		cumin seeds	½ tsp	1 tsp	1 tsp
		green chilli (minced)	½ tsp	1 tsp	1 tsp
		ginger paste	½ tsp	1 tsp	1 tsp
		garlic paste	½ tsp	1 tsp	1 tsp
		turmeric powder	¼ tsp	½ tsp	½ tsp
		red chilli powder	1 tsp	1½ tsp	2 tsp
		hing a pinch			
		oil as required			
		salt to taste			
Method of preparation					
Prepare tadka in a microwave oven safe bowl as explained in Insta 2 with all the ingredients other than spinach leaves and mustard greens. Remove; add the remaining ingredients and mix well. Cover the bowl with lid and place it in the microwave oven. Select Insta 4, enter weight and press start. Remove, mix well and serve hot.					

BESAN KA LADOO	Insta 4	BESAN KA LADOO	250gms	350gms	450gms
		Ingredients:			
		besan	1½ cups	2 cups	2½ cups
		sugar (grinded)	¾ cup	1 cup	1½ cup
		ghee	¾ cup	1 cup	1 cup
		almonds (roasted)	few	few	few
		pistachios	few	few	few
		cashew nuts (roasted)	few	few	few
Method of preparation;					
Take a microwave oven safe glass bowl, add ghee and besan, mix well and place the bowl in the microwave oven select Insta 4, enter weight and press start.(stir twice in-between to avoid lumps).After beep, remove and add all the ingredients to the flour, mix thoroughly and form small balls like ladoo.					

APPLE JAM	Insta 4	APPLE JAM	250 gms	350 gms	450 gms
		Ingredients;			
		Apples cut into slices	250gms	350gms	450gms
		Sugar	150gms	200gms	300gms
		Lemon juice or Citric acid	1 tsp	1½ tsp	1½ tsp
		Water as required			
		Method of preparation			
Prepare tadka in a microwave oven safe bowl as explained in Insta 2 with all the ingredients other than pakodas, tomato puree and coriander leaves. After beep, remove, add the remaining ingredients other than the coriander leave and mix well. Place the bowl in the microwave oven selects Insta 4, enter weight and press start. Remove, garnish with grated coriander and serve.					

PAKODA CURRY	Insta 4	PAKODA CURRY	250gms	350gms	450gms
		Ingredients:			
		pakodas	250gms	350gms	450gms
		tomato puree	1 cup	1½ cup	1½ cup
		green chilli	2	2	3
		ginger paste	½ tsp	½ tsp	1 tsp
		curry leaves	few	few	few
		mustard seeds	½ tsp	½ tsp	1 tsp
		cumin seeds	½ tsp	½ tsp	1 tsp
		hing	a pinch	a pinch	a pinch
		coriander powder	½ tsp	½ tsp	1 tsp
		red chilli powder	½ tsp	½ tsp	1 tsp
		sugar	1 tsp	1½ tsp	2 tsp
		turmeric	a pinch	a pinch	a pinch
		salt to taste			
		coriander leaves for garnish			
Method of preparation					
Prepare tadka in a microwave oven safe bowl as explained in Insta 2 with all the ingredients other than pakodas, tomato puree and coriander leaves. After beep, remove, add the remaining ingredients other than the coriander leave and mix well. Place the bowl in the microwave oven selects Insta 4, enter weight and press start. Remove, garnish with grated coriander and serve.					

PULIHORA	Insta 4	PULIHORA	250gms	350gms	450gms
		Ingredients:			
		cooked rice	2 cup	2 ½ cup	3 cup
		tamarind juice	1 cup	1½ cup	2 cup
		channa dal	2 tsp	3 tsp	3tsp
		dried red chilly	3	3	4
		turmeric powder	¼ tsp	¼ tsp	¼ tsp
		curry leaves	few	few	few
		jaggery grated	1 tsp	2 tsp	3 tsp
		fenugreek	½ tsp	1 tsp	1½ tsp
		hing	a pinch	a pinch	a pinch
		mustard	½ tsp	½ tsp	1 tsp
		oil as required	1 tbsps	1 tbsps	1 tbsps
		peanuts	2 tsp	2 tsp	2 tsp
		salt to taste			
		Method of preparation			
		Prepare tadka in a microwave oven safe bowl as explained in Insta 2 with all the ingredients other than tamarind juice and cooked rice. After beep, Remove, add the remaining ingredients and mix well. Place the bowl in the microwave oven selects Insta 4, enter weight and press start.			

AAMTI	Insta 5	AAMTI	50g/ 450g	100g/ 800g	
		Ingredients:			
		moong dal	1½ cup	2 cup	
		chopped tomato	1 cup	1½ cup	
		green chillies	3	4	
		curry leaves	few	few	
		mustard seeds	½ tsp	¾ tsp	
		hing	a pinch	a pinch	
		turmeric powder	¼ tsp	½ tsp	
		cumin seeds	½ tsp	¾ tsp	
		oil as required			
		salt to taste			
		water as required			
		coriander leaves for garnish			
		Method of preparation			
		Prepare tadka in a microwave oven safe bowl as explained in Insta 2 with all the ingredients other than moong dal, tomato, hing, coriander leaves and water. After beep, remove, add the remaining ingredients other than coriander leaves and mix well. Place the bowl in the microwave oven, select Insta 4, enter weight and press start. remove and garnish with coriander leaves. serve hot.			

Spaghetti	Insta 5	Spaghetti	50g/ 450g	100g/ 800g	
		Ingredients;			
		spaghetti	1½ cup	1½ cup	
		carrot - chopped	½ cup	½ cup	
		butter	½ tbsp	1 tbsp	
		capsicum - chopped	½ cup	½ cup	
		mushrooms - chopped	½ cup	½ cup	
		tomatoes - chopped	½ cup	½ cup	
		oregano	a pinch	a pinch	
		basil	a pinch	a pinch	
		green peas	½ cup	½ cup	
		green onion - chopped	½ tbsp	1 tbsp	
		tomato ketchup (optional)	½ tbsp	1 tbsp	
		grated cheese for garnish			
		salt to taste			
		Method of preparation			
		Prepare tadka in a microwave oven safe glass bowl as explained in Insta 2 with all the ingredients other than tomatoes, spaghetti, green peas and tomato ketchup; mix well. Remove, add the remaining ingredients other than grated cheese and mix well. Place the bowl in the microwave oven, select Insta 5, enter weight and press start. Remove, garnish and serve.			

PASTA	Insta 5	PASTA	50g/ 450g	100g/ 800g	
		Ingredients:			
		pasta	1½ cup	2 cups	
		garlic paste	½ tsp	1tsp	
		cumin's	½ tsp	1tsp	
		garam masala	1 tsp	1½ tsp	
		red chilli powder	½ tsp	1tsp	
		coriander powder	1 tsp	1½ tsp	
		tomato puree	½ cup	1 cup	
		butter as required			
		salt to taste			
		grated cheese for garnish			
		water as required			
		Method of preparation:			
		Prepare tadka in a microwave oven safe glass bowl as explained in Insta 2 with all the ingredients other than tomato puree, pasta, grated cheese& water.mix well. Remove, add the remaining ingredients other than grated cheese and mix well. Place the bowl in the microwave oven, select Insta 5, enter weight and press start. Remove, garnish and serve.			

BASUNDI	Insta 5	BASUNDI	50g/ 450g	100g/ 800g
		Ingredients:		
		milk	6 cups	8 cups
		sugar	2tbsp	2½ tbsp
		chopped almonds	6	8
		lemon juice (optional)	1½ tsp	2 tsp
		crushed cardamoms	6	8
		chopped charoli nuts (saara)	1 tsp	1½ tsp
		Method of preparation:		
Take a microwave safe bowl, add Milk & Sugar, stir well, keep in the bowl in the microwave oven select insta 5, enter weight & press start. After beep, remove & add all the remaining ingredients & select Tadka Option in Insta 2, enter weight & press start & serve hot.				

PAYASAM	Insta 5	PAYASAM	50g/ 450g	100g/ 800g
		Ingredients:		
		milk	6 cups	8 cups
		vermicelli (seviya)	1½ cups	2 cups
		sugar	1½ cup	2 cup
		cardamom	6	8
		cashew nuts	½ tbsp	¾ tbsp
		almonds	½ tbsp	¾ tbsp
		ghee	1 tbsp	1½ tbsp
Method of preparation				
Prepare tadka in a microwave oven safe bowl as explained in Insta 2 with all the ingredients other than milk, sugar, cardamom. Remove, add the remaining ingredients and mix well. Place the bowl in the microwave oven, select Insta 5, enter weight and press start. Remove, and serve hot.				

GAJAR KA HALWA	Insta 5	GAJAR KA HALWA	50g/ 450g	100g/ 800g
		Ingredients:		
		carrots (grated)	50g/ 450g	100g/ 800g
		kawa (mawa grated)	1½ cup	2 cup
		sugar	2 cup	2½ cup
		milk condensed	1cup	1½ cup
		milk	1cup	1½ cup
		cardamoms	few	few
		pistachio flakes (almonds)	few	few
		raisins	few	few
		ghee as required		
		Method of preparation:		
Prepare tadka in a microwave oven safe bowl as explained in Insta 2 with all the ingredients other than milk, condensed milk, cardamom, flakes and raisins. After beep, remove, add the remaining ingredients and mix well. Place the bowl in the microwave oven selects Insta 5, enter weight and press start.				

CHICKEN XACUTI	Insta 5	CHICKEN XACUTI	50g/ 450g	100g/ 800g	
		Ingredients:			
		Chicken	50g/ 450g	100g/ 800g	
		Small Potatoes	few	few	
		Small Onions	few	few	
		Nutmeg Powder	¼ tsp	½ tsp	
		Coconut Paste	1 cup	1½ cup	
		Xacuti Masala Ingredients:			
		Red Chillies	5	6	
		Coconut Pieces	few	few	
		Cloves	3	4	
		Turmeric Powder	¼ tsp	½ tsp	
		Pepper Corns	few	few	
		Jeera	½ tsp	1 tsp	
		Methi Seeds	½ tsp	1 tsp	
		Saunf	2 tsp	3 tsp	
		Garlic Flakes	4	5	
		Ginger	½ " inch	1 " inch	
		Cinnamon	½ " inch	1 " inch	
		Khus Khus	1 cup	1½ cup	
		Coriander Seeds	2 tsp	3 tsp	
		Sesame seeds	2 tsp	3 tsp	
		Onion	2	2	
			Method of preparation:		
			Make a fine paste of all masala ingredients. Prepare tadka as explained in Insta 2 in a microwave oven safe bowl with all the ingredients other than chicken and potato. After the beep, remove and add all remaining ingredients, mix well. Place the bowl in the microwave oven. Select Insta 5, enter weight and press start. Serve hot.		

OLAN	Insta 5	OLAN	50g/ 450g	100g/ 800g		
		Ingredients:				
		black-eyed beans (soaked)	1½ cup	1½ cup		
		pumpkin, cubed	2 cup	1½ cup		
		onion sliced thin	1½ cup	1½ cup		
		Jeera	1½ tsp	2 tsp		
		mustard seeds	1 tsp	1½ tsp		
		curry leaves	few	few		
		green chillies chopped	few	few		
		coconut milk	1½ cup	2 cup		
		coconut oil as required				
		salt to taste				
		Method of preparation:				
		Prepare tadka in a microwave oven safe bowl as explained in Insta 4 with all the ingredients other than pumpkin and coconut milk. After beep, remove, add the remaining ingredients and mix well. Place the bowl in the microwave oven select Insta 5, enter weight and press start.				

CURD RICE	Insta 5	CURD RICE	50g/ 450g	100g/ 800g
		Ingredients;		
		rice	1½ cup	2 cups
		dahi / yogurt	200 gms	300 gms
		milk	1 cup	1½ cup
		mustard seeds	½ tsp	½ tsp
		cumin's seeds	½ tsp	½ tsp
		dry red chilly (cut into small)	2	3
		ghee	1 tbsps	1 tbsps
		medium size cucumber grated	½	¾
		seedless grapes (chopped)	50 gms	75 gms
		pomegranate (dalim) seeds	¼ cut	½ cut
		water as required		
		salt to taste		
		Method of preparation		
Prepare tadka in a microwave oven safe bowl as explained in Insta 2 with all the ingredients other than rice, yogurt, milk, cucumber, grapes, dalim and water. Remove, add the remaining ingredients other than grapes, and dalim, mix well. Place the bowl in the microwave oven, select Insta 5, enter weight and press start. Remove, add grapes, dalim and serve hot.				

DALCHA	Insta 5	DALCHA	50g/ 450g	100g/ 800g
		Ingredients:		
		soaked channa dal	50 gms	100 gms
		lauki (cut into pieces)	1 cup	1½ cup
		oil	1 tbsp	1 tbsp
		onion paste	1 cup	1 cup
		curry leaves	few	few
		red chilli powder	1 tsp	1½ tsp
		turmeric powder	¼ tsp	½ tsp
		ginger paste	½ tsp	¾ tsp
		garlic paste	½ tsp	¾ tsp
		cumin seeds	1 tsp	1½ tsp
		tamarind juice	½ cup	¾ cup
		salt to taste		
		water as required		
Method of preparation				
Prepare tadka in a microwave oven safe bowl as explained in Insta 2, with all the ingredients other than channa dal, lauki, tamarind juice and water. Remove, add the remaining ingredients except coriander leaves and mix well. Place the bowl in the microwave oven, select Insta 5, enter weight and press start. Remove, garnish with coriander and serve hot.				

JEERA RICE	Insta 5	JEERA RICE	50g/ 450g	100g/ 800g		
		Ingredients:				
		rice	1 cup	1½ cup		
		jeera (cumin seeds)	2 tsp	2 tsp		
		cashew nuts	2 tbsp	2 tbsp		
		peppercorns	4	5		
		bay leafs	2	3		
		cloves	3	4		
		cinnamon sticks	2	3		
		onions, sliced	1	2		
		ghee as required				
		salt To Taste				
		water as required				
		Method of preparation				
		Prepare tadka in a microwave oven safe bowl as explained in Insta 2 with all the ingredients other than rice and water. Remove, add the remaining ingredients and mix well. Place the bowl in the microwave oven, select Insta 5, enter weight and press start. Remove, and serve hot.				

EGGPLANT DAL	Insta 5	EGGPLANT DAL	50g/ 450g	100g/ 800g
		Ingredients:		
		toovar dal	1 cup	1½ cup
		eggplants chopped	1 cup	2 cup
		dried coconut	1tbsp	1tbsp
		turmeric powder	¼ tsp	¼ tsp
		green chillies	3	4
		cumin's seeds	½ tsp	¾ tsp
		garlic, ginger paste	1 tsp	1½ tsp
		mustard seeds	½ tsp	¾ tsp
		oil as required		
		salt to taste		
Method of preparation				
Prepare tadka in a microwave oven safe bowl as explained in Insta 2 with all the ingredients other than dal and egg plants. Remove. add the remaining ingredients and mix well. Place the bowl in the microwave oven, select Insta 5, enter weight and press start. Remove, and serve hot.				

AMRITSARI DAL	Insta 5	AMRITSARI DAL	50g/ 450g	100g/ 800g
		Ingredients:		
		urad dal	1 cup	2 cup
		channa dal	1 cup	2 cup
		tomatoes	2	3
		onion chopped	1	2
		mint leaves	few	few
		ginger, garlic paste	1 tsp	1½ tsp
		green chillies chopped	2	2
		butter as required		
		salt to taste		
		Method of preparation		
Prepare tadka in a microwave oven safe bowl as explained in Insta 2 with all the ingredients other than urad & channa dal. Remove. add the remaining ingredients and mix well. Place the bowl in the microwave oven, select Insta 5, enter weight and press start. Remove, and serve hot.				

DAL MAKHANI	Insta 5	DAL MAKHANI	50g/ 450g	100g/ 800g
		Ingredients:		
		urad daal	1 cup	1½ cup
		tomato finely chopped	2	3
		onion finely chopped	1	1
		ginger, garlic paste	1 tsp	1½ tsp
		chillies finely chopped	few	few
		curd	1 cup	1½ cup
		cream (malai)	½ cup	¾ cup
		cumin seeds	½ tsp	¾ tsp
		turmeric powder	¼ tsp	¼ tsp
		garam masala	1 tsp	1½ tsp
		red chilli powder	1 tsp	1½ tsp
		dhania powder	1 tsp	1½ tsp
		butter as required		
		chopped coriander leaves for garnish		
		salt to taste		
		Method of preparation		
Prepare tadka in a microwave oven safe bowl as explained in Insta 2 with all the ingredients other than urad dal, tomato, cream, curd and coriander. Remove. add the remaining ingredients other than coriander and mix well. Place the bowl in the microwave oven, select Insta 5, enter weight and press start. Remove, and garnish with coriander leaves. serve hot.				

RASAM	Insta 5	RASAM	50g/ 450g	100g/ 800g
		Ingredients:		
		red gram dal	1 cup	1½ cup
		tomatoes	1	2
		ginger paste	½ tsp	¾ tsp
		garlic paste	½ tsp	¾ tsp
		green chillies chopped	1	2
		turmeric powder	¼ tsp	¼ tsp
		mustard seeds	½ tsp	¾ tsp
		cumin seeds	½ tsp	¾ tsp
		dried red chillies	2	3
		hing	a pinch	a pinch
		curry leaves	few	few
		pepper powder	½ tsp	¾ tsp
		oil as required	1 tbsps	1 tbsps
		salt to taste		
		coriander leaves for garnish		
		Method of preparation		
Prepare tadka in a microwave oven safe bowl as explained in Insta 2 with all the ingredients other than tomato, hing and coriander. Remove. add the remaining ingredients other than coriander and mix well. Place the bowl in the microwave oven, select Insta 5, enter weight and press start. Remove, and garnish with coriander leaves. serve hot.				

CHICKEN KURMA	Insta 5	CHICKEN KURMA	50g/ 450g	100g/ 800g
		Ingredients:		
		chicken	50g/ 450g	100g/ 800g
		grated coconut	½ cup	1cup
		curd	1½ cup	2 cups
		ginger, garlic paste	1 tsp	1½ tsp
		onions, chopped		1 tsp
		garam masala	1 tsp	1½ tsp
		ground coriander	1 tsp	1½ tsp
		green chilli paste	1 tsp	1½ tsp
		cumin	1 tsp	1½ tsp
		cardamom	4	6
		cinnamon sticks	3	4
		turmeric powder	¼ tsp	½ tsp
		bay leaves	3	4
		coriander for garnish		
		oil as required		
		salt to taste		
Method of preparation:				
Marinate the chicken with the curd, turmeric powder, ginger, garlic paste, garam masala and ground coriander for 1 hour. Prepare tadka in a microwave oven safe bowl as explained in Insta 2 with all the ingredients other than marinated chicken, coriander leaves and bay leaves. After beep, remove, add the remaining ingredients other than coriander leave and mix well. Place the bowl in the microwave oven selects Insta 5, enter weight and press start. Remove, add coriander leaves and Serve hot.				

CAKE - BROWNIE	Insta 6	CAKE - BROWNIE	200g	400g	600g
		Ingredients:			
		flour - sifted	1 cup	1½ cup	2 cup
		margarine	1½ tbsp	2 tbsp	2½ tbsp
		sugar	1 cup	1½ cup	2 cup
		baking powder	½ tsp	1 tsp	1 tsp
		cocoa powder	½ cup	¾ cup	1 cup
		walnuts	¼ tbsp	½ tbsp	½ tbsp
Method of preparation;					
Mix the margarine and sugar in a mixing bowl until the sugar is completely dissolved. Add cocoa powder, flour, nuts, baking powder and mix well until smooth. Pour into a lightly greased glass bowl, Place in the microwave oven, select Insta 6, enter weight and press start. Remove, allow to cool and serve.					

UPMA	Insta 6	UPMA	200 gms	400 gms	600 gms
		Ingredients;			
		roasted semolina (suji)	1½ cup	2 cup	2½ cup
		onions medium sized (finely chopped)	1	2	2
		green chilly (finely chopped)	2	3	4
		curry leaves	few	few	few
		mustard	½ tsp	½ tsp	1 tsp
		cumin's seeds	½ tsp	½ tsp	1 tsp
		turmeric powder	¼ tsp	½ tsp	½ tsp
		groundnuts (roasted)	½ tbsps	½ tbsps	1 tbsps
		channa dhal	2 tsp	2 tsp	3 tsp
		urad dhal	2 tsp	2 tsp	3 tsp
		tomato (chopped)	¼ cup	¼ cup	½ cup
		green peas	½ tbsps	½ tbsps	1 tbsps
		carrot (chopped)	¼ cup	¼ cup	½ cup
		ghee as required			
		salt to taste			
		water as required			
		grated coconut & shev for garnish			
		Method of preparation:			
		Prepare tadka in a microwave oven safe bowl as explained in Insta 2 with all the ingredients other than roasted suji and water. After beep, remove and add the remaining ingredients, mix well. Place the bowl in the microwave oven, select Insta 6, enter weight and press start. Garnish with coconut & shev, serve hot.			

FRUIT CUSTARD	Insta 6	FRUIT CUSTARD	200g	400g	600g
		Ingredients:			
		Custard Powder	½ cup	½ cup	1 cup
		Milk	2 cup	3 cup	5 cup
		Sugar	1 cup	1½ cup	2 cups
		Apple	1	1	2
		Banana	2	2	3
		Pineapple Slices	¼ cup	¼ cup	½ cup
		Strawberries	¼ cup	¼ cup	½ cup
		Black Grapes (Seedless)	¼ cup	¼ cup	½ cup
		Green Grapes (Seedless)	¼ cup	¼ cup	½ cup
		Cherries To Garnish	¼ cup	¼ cup	½ cup
		Method of preparation;			
		Take a microwave oven safe large glass bowl; add milk, sugar, custard powder and mix well. Place the bowl in the microwave oven, select Insta 6, enter weight and press start. Slice the apple, banana, pineapple into pieces and put them into a bowl which is large enough to hold all the contents. The grapes and the strawberries need not be cut and should be added along with it. Add custard to the fruits and mix gently. Set to cool and serve.			

NOODLES	Insta 6	NOODLES	200g	400g	600g
		Ingredients:			
		Noodles – Boiled	200g	400g	600g
		Mixed Vegetables(Carrots, Beans, Cauliflower, Baby Corn)	1 cup	1½ cup	2 cups
		Mushrooms – Sliced	½ cup	½ cup	1 cup
		Garlic – Chopped	½ tsp	½ tsp	1 tsp
		Ginger – Chopped	½ tsp	½ tsp	1 tsp
		Soya Sauce	2 tsp	3 tsp	4 tsp
		Spring Onions – Chopped	½ tbsp	½ tbsp	1 tbsp
		Oil As Required			
		Pepper To Taste			
		Salt To Taste			
		Method of preparation:			
		Prepare tadka as mentioned in Insta 2 with all the ingredients other than noodles and soya sauce. After beep, remove, add noodles & soya sauce, mix smoothly, select Insta 6, enter weight and press start. Serve hot			

PALAK PANEER	Insta 6	PALAK PANEER	200g	400g	600g
		Ingredients:			
		Paneer	200g	400g	600g
		Palak Paste	2 cup	3 cup	4 cup
		Onion Paste	1 cup	2 cup	3 cup
		Black Pepper Powder	½ tsp	½ tsp	1 tsp
		Ginger-Garlic Paste	1 tsp	1 tsp	1½ tsp
		Green Chilli Paste	1 tsp	1 tsp	1½ tsp
		Bay Leaves	2	3	4
		Cumin Seeds	1 tsp	1 tsp	1½ tsp
		Garam Masala Powder	1 tsp	2 tsp	2½ tsp
		Butter As Required			
		Coriander Leaves For Garnish			
		Salt To Taste			
		Method of preparation:			
		Prepare tadka in a microwave oven safe bowl as explained in Insta 2 with all the ingredients other than paneer, spinach paste, and salt. Remove, add the remaining ingredients and mix well. Place the bowl in the microwave oven, select Insta 6, enter weight and press start. Remove, garnish with coriander and serve.			

BAINGAN MASALA	Insta 6	BAINGAN MASALA	200g	400g	600g
		Ingredients:			
		brinjal (baingan), cut into half	200g	400g	600g
		tomatoes, chopped	2	3	4
		onions, chopped	1	2	2
		methi leaves (fenugreek)	½ cup	¾ cup	1 cup
		garlic paste	½ tsp	¾ tsp	1 tsp
		cumin seeds	1 tsp	1½ tsp	2 tsp
		curry leaves	few	few	few
		turmeric powder	¼ tsp	¼ tsp	½ tsp
		red chilli powder	1½ tsp	2 tsp	3 tsp
		oil as required			
		coriander for garnish			
		salt & pepper to taste			
Method of preparation					
Prepare tadka in a microwave oven safe bowl as explained in Insta 2 with all the ingredients other than tomato, methi leaves, vinegar, salt and pepper. After beep, Remove, add the remaining ingredients and mix well. Place the bowl in the microwave oven, select Insta 6, enter weight and press start. Remove, garnish with coriander and serve.					

CARROT SOUP	Insta 6	CARROT SOUP	200g	400g	600g
		Ingredients:			
		Carrot – Chopped	200g	400g	600g
		Sweet Potato – Chopped	½ cup	¾ cup	1 cup
		Onion – Chopped	1 cup	1½ cup	1½ cup
		Vegetable Broth	1 cup	1½ cup	1½ cup
		Coconut Milk	1 cup	1½ cup	1½ cup
		Ginger Sliced	½ tsp	½ tsp	1 tsp
		Garlic Chopped	½ tsp	½ tsp	1 tsp
		Curry Powder	½ tsp	½ tsp	1 tsp
		Pepper Powder	1 tsp	1 tsp	1½ tsp
		Salt To Taste			
Method of preparation;					
Prepare tadka in a microwave oven safe bowl as explained in Insta 2 with all the ingredients other than carrots, sweet potato, vegetable broth and coconut milk, After beep, remove, add the remaining ingredients, mix well. Place the bowl in the microwave oven, select Insta 6, enter weight and press start. Remove, allow it to cool and blend in a juicer. Drain, reheat and serve.					

TOMATO CHUTNEY	Insta 6	TOMATO CHUTNEY	200g	400g	600g
	Ingredients:				
	Tomatoes – Chopped		200g	400g	600g
	Onion - Large Chopped		1	1	2
	Garlic – Chopped		½ tsp	½ tsp	1 tsp
	Red Chilli Powder		1 tsp	1 tsp	1½ tsp
	Tamarind Extract (Juice)		½ cup	½ cup	1 cup
	Oil As Required				
	Salt To Taste				
	For seasoning:				
	Oil As Required				
	Curry Leaves As Required				
	Mustard Seeds As Required				
	Pinch Of Asafetida Powder				
Method of preparation;					
Take a microwave oven safe bowl; add oil, onion, garlic, salt, tomatoes, red chilli powder, and tamarind juice and mix well. Place the bowl in the microwave oven, select Insta 2, enter weight and press start. Remove and allow to cool grind into a fine paste. Take a microwave oven safe bowl; add the ingredients for seasoning and place it in the microwave oven. Select Insta 6, enter weight and press start. Remove, add to the tomato mixture, mix well and serve.					

MUSHROOM SOUP	Insta 6	MUSHROOM SOUP	200g	400g	600g	
	Ingredients:					
	Button Mushrooms		200g	400g	600g	
	Chicken Stock		1 cup	1½ cup	2 cup	
	Spring Onions, Chopped Finely		½ tbsp	½ tbsp	1 tbsp	
	Ginger Paste		½ tsp	½ tsp	1 tsp	
	Black Peppers		few	few	few	
	Salt To Taste					
	Method of preparation;					
	Prepare tadka in a microwave oven safe glass bowl as explained in Insta 2, with all the ingredients other than mushrooms and salt. Remove, add all remaining ingredients and mix well. Place the bowl in the microwave oven, select Insta 6, enter weight and press start. Remove and serve.					

PUDINA CHUTNEY	Insta 6	PUDINA CHUTNEY	200g	400g	600g
		Ingredients:			
		Pudina Leaves	200g	400g	600g
		Raw Mango Peeled, Chopped	1 cup	1½ cup	2 cup
		Sesame Seeds	½ cup	½ cup	1 cup
		Green Chillies / Red Chillies	3	4	5
		Mustard Seeds	1 tsp	1 tsp	1 tsp
		Cumin Seeds	1 tsp	1 tsp	1 tsp
		Chana Dal, Soaked	½ tbsp	½ tbsp	1 tbsp
		Asafetida	a pinch	a pinch	a pinch
		Oil As Required			
		Salt To Taste			
		Method of preparation;			
Prepare tadka in a microwave oven safe glass bowl as explained in Insta 2, with all the ingredients other than raw mango, pudina leaves, salt. Remove, add all remaining ingredients and mix well. Place the bowl in the microwave oven, select Insta 6, enter weight and press start. Remove and serve.					

BHENDI FRY	Insta 6	BHENDI FRY	200g	400g	600g
		Ingredients:			
		Lady Finger	200g	400g	600g
		Gram Flour	½ cup	1 cup	1½ cup
		Sliced Onion	½ cup	1 cup	1½ cup
		Sliced Green Chilli	2	3	4
		Coriander Powder	½ tsp	1 tsp	1½ tsp
		Red Chilli Powder	1 tsp	1½ tsp	2 tsp
		Garam Masala Powder	1 tsp	1½ tsp	2 tsp
		Cumin Seeds	½ tsp	1 tsp	1½ tsp
		Turmeric Powder	¼ tsp	¼ tsp	½ tsp
		Oil As Required			
		Salt To Taste			
Method of preparation;					
Prepare tadka in a microwave oven safe glass bowl as explained in Insta 3 with all the ingredients other than lady finger. Remove, add lady fingers and mix well. Place the bowl in the microwave oven, select Insta 2, enter weight and press start. Remove and serve.					

METHI MALAI MATAR	Insta 6	METHI MALAI MATAR	200g	400gms	600gms
		Ingredients:			
		Methi Leaves	100 gms	200 gms	300 gms
		Green Peas	100 gms	200 gms	300 gms
		Malai / Cream	½ cup	1 cup	1½ cup
		Onion Paste	½ cup	1 cup	1½ cup
		Green Chilli Paste	1 tsp	1½ tsp	2 tsp
		Garlic, Ginger Paste	½ tsp	½ tsp	1 tsp
		Khus Khus Paste	½ tbsp	½ tbsp	1 tbsp
		Cumins	½ tsp	½ tsp	1 tsp
		Cashew Nuts	4	5	6
		Milk	1 cup	1½ cup	2 cup
		Oil As Required			
		Salt To Taste			
		Method of preparation:			
		Prepare tadka as explained in Insta 2 in a microwave oven safe glass bowl with all the ingredients other than methi leaves, green peas, malai and milk. Remove; add methi leaves, green peas, malai, and milk and mix well. Cover the bowl with lid and place it in the microwave oven. Select Insta 6, enter weight and press start. Remove and serve.			

GREEN PEAS CURRY	Insta 6	GREEN PEAS CURRY	200g	400g	600g
		Ingredients:			
		Green Peas	200g	400g	600g
		Tomato	1	2	2
		Onions	1	2	2
		Ginger, Garlic Paste	1 tsp	1½ tsp	2 tsp
		Green Chillies	1	2	2
		Turmeric Powder	¼ tsp	¼ tsp	½ tsp
		Coriander Leaves	few	few	few
		Garam Masala Powder	1 tsp	1½ tsp	2 tsp
		Coriander Powder	¼ tsp	¼ tsp	½ tsp
		Chilly Powder	1 tsp	1½ tsp	2 tsp
		Mustard Seeds	¼ tsp	¼ tsp	½ tsp
		Black Pepper Powder	¼ tsp	¼ tsp	½ tsp
		Coconut Milk	½ cup	½ cup	1 cup
		Curry Leaves	few	few	few
		Oil As Required			
		Salt To Taste.			
		Method of preparation;			
		Prepare tadka in a microwave oven safe glass bowl as explained in Insta 2 with all the ingredients other than tomato, green peas and coconut milk. After beep, remove; add the remaining ingredients mix well. Place the bowl in the microwave oven, select Insta 6, enter weight and press start.			

GRATED RADISH CURRY	Insta 6	GRATED RADISH CURRY	200g	400g	600g
		Ingredients:			
		Radish (Grated)	200g	400g	600g
		Coconut (Grated)	1 cup	1½ cup	2 cup
		Onion Chopped	1 cup	1½ cup	2 cup
		Chilli Powder	1½ tsp	2 tsp	3 tsp
		Chopped Green Chillies	3	4	5
		Turmeric Powder	¼ tsp	½ tsp	½ tsp
		Mustard Seeds	½ tsp	1 tsp	1 tsp
		Curry Leaves	few	few	few
		Oil As Required			
		Salt To Taste			
		Coriander Leaves For Garnish			
		Method of preparation:			
		Prepare tadka as explained in Insta 2 in a microwave oven safe glass bowl with all the ingredients other than grated radish, grated coconut and coriander leaves. Remove; add all remaining ingredients other than coriander leaves and mix well. Cover the bowl with lid and place it in the microwave oven. Select Insta 6, enter weight and press start. Remove, garnish with coriander leaves and serve.			

CASHEW BURFI	Insta 6	CASHEW BURFI	200g	400g	600g
		Ingredients:			
		Cashew Nuts Powder	3 cup	4 cup	5 cup
		Powdered Sugar	1½ cup	2 cup	2½ cup
		Ghee	¼ cup	½ cup	¾ cup
		Elaichi Powder	¼ tsp	¼ tsp	½ tsp
		Water As Required			
		Silver Warq Few Sheets (Optional)			
		Method of preparation:			
		Take a microwave oven safe glass bowl, add water and sugar to make sugar syrup, select Insta 2, set weight, press start. After beep, remove and add cashew powder, ghee, stir well and select Insta 6, set weight, press start. Pour the cashew mixture in a lightly greased tray. Apply silver warq over the cashew mixture. Set to cool and cut into diamond shape pieces.			

ALOO MATAR	Insta 6	ALOO MATAR	200g	400g	600g
		Ingredients:			
		Potatoes	150 gms	300 gms	400 gms
		Green Peas	50 gms	100 gms	200 gms
		Curd	1 cup	1½ cup	2 cup
		Green Chillies	2	2	3
		Turmeric Powder	¼ tsp	¼ tsp	½ tsp
		Onion	1	2	3
		Tomatoes Puree	1 cup	1½ cup	2 cup
		Ginger	½ tsp	½ tsp	1 tsp
		Coriander Powder	½ tsp	½ tsp	1 tsp
		Red Chilli Powder	1 tsp	1 tsp	1½ tsp
		Garam Masala	1 tsp	1 tsp	1½ tsp
		Oil As Required			
		Salt To Taste			
		Coriander Leaves For Garnish			
Method of preparation:					
Prepare tadka in a microwave oven safe glass bowl as explained in Insta 2, with all the ingredients other than tomato puree, salt, green peas, and curd. Remove, add all remaining ingredients and mix well. Place the bowl in the microwave oven, select Insta 6, enter weight and press start. Remove, garnish with coriander leaves and serve.					

COCONUT PAYASAM	Insta 6	COCONUT PAYASAM	200g	400g	600g
		Ingredients:			
		Grated Coconut	2 cup	3 cup	4 cup
		Jaggery	1 cup	1½ cup	2 cup
		Milk	1 cup	1½ cup	2 cup
		Ghee	3 tsp	4 tsp	5 tsp
		Roasted Cashew Nuts	6	8	10
		Cardamom Powder	a pinch	a pinch	a pinch
Method of preparation:					
Grind coconut and squeeze milk from it 2 times. Take a microwave oven safe bowl; add ghee, coconut milk, jaggery and milk, cardamom powder, mix well. Place the bowl in microwave oven select Insta 6, set weight, press start. After beep, remove and add cashew. Serve hot.					

SWEET POTATO SOUP	Insta 6	SWEET POTATO SOUP	200g	400g	600g
		Ingredients:			
		Sweet Potato Chopped	200g	400g	600g
		Onion Chopped	1	2	3
		Nutmeg Powder	a pinch	a pinch	a pinch
		Black Pepper Powder	a pinch	a pinch	a pinch
		Milk Or Heavy Cream	1 cup	1½ cup	2 cup
		Corn Flour	1 tbsp	1½ tbsp	2 tbsp
		Vegetable Stock	1 cup	1½ cup	2 cup
		Lemon Juice	1 tsp	1 tsp	1½ tsp
		Butter	1 tbsp	1½ tbsp	2 tbsp
		Salt To Taste			
		Method of preparation:			
		Prepare tadka as explained in Insta 2 in a microwave oven safe bowl with all the ingredients other than nutmeg powder, pepper powder, milk, vegetable stock and lemon juice. After the beep, remove and add all remaining ingredients, mix well. Place the bowl in the microwave oven. Select Insta 6, enter weight and press start. Remove and make puree of the sweet potato mixture. Serve hot.			

TINDORA FRY	Insta 6	TINDORA FRY	200g	400g	600g
		Ingredients:			
		Tindora Chopped	200g	400g	600g
		Roasted Dalia Powder	1 cup	1½ cup	2 cup
		Ajwain	1 tsp	1 tsp	1½ tsp
		Red Chilli Powder	1 tsp	1½ tsp	2 tsp
		Turmeric Powder	a pinch	a pinch	a pinch
		Mustard Seeds	½ tsp	½ tsp	1 tsp
		Cumin Seeds	1 tsp	1½ tsp	2 tsp
		Curry Leaves	few	few	few
		Oil As Required			
		Salt To Taste			
		Method of preparation:			
		Prepare tadka as explained in Insta 2 in a microwave oven safe bowl with all the ingredients other than tindora and salt. After the beep, remove and add all remaining ingredients, mix well. Place the bowl in the microwave oven. Select Insta 6, enter weight and press start. Serve hot.			

CAPSICUM WITH PEANUTS	Insta 6	CAPSICUM WITH PEANUTS	200g	400g	600g
		Ingredients:			
		Capsicum	200g	400g	600g
		Raw Peanuts Powder	2 tbsp	3 tbsp	4 tbsp
		Urad Dal	1 Tbsp	2 tbsp	3 tbsp
		Whole Red Chilli	3	4	5
		Tamarind (Optional)	1" piece	2" piece	3" piece
		Mustard Seeds	½ tsp	½ tsp	1 tsp
		Cumin Seeds	½ tsp	1 tsp	1½ tsp
		Urad Dal	1 tsp	1½ tsp	2 tsp
		Curry Leaves	few	few	few
		Oil As Required			
		Salt To Taste			
		Method of preparation;			
		Prepare tadka in a microwave oven safe glass bowl as explained in Insta 2 with all the ingredients other than capsicum and tamarind, after beep. Remove, add the remaining ingredients and mix well. Place the bowl in the microwave oven, select Insta 6, enter weight and press start. Serve hot.			

SARSON KA SAAG	Insta 6	SARSON KA SAAG	200g	400g	600g
		Ingredients:			
		Spinach Chopped	2 cup	2½ cup	3 cup
		Mustard Greens Chopped	2 cup	2½ cup	3 cup
		Green Chillies	2	3	4
		Ginger Paste	½ tsp	½ tsp	1 tsp
		Garlic Paste	½ tsp	½ tsp	1 tsp
		Onion Grated	½ cup	1 cup	1½ cup
		Coriander Powder	1 tsp	1½ tsp	2 tsp
		Cumin Powder	1 tsp	1½ tsp	2 tsp
		Garam Masala Powder	1½ tsp	2 tsp	3 tsp
		Lime Juice	1 tsp	1½ tsp	2 tsp
		Bengal Gram Flour	1 tbsp	1½ tbsp	2 tbsp
		Ghee As Required			
		Salt To Taste			
		Method of preparation:			
		Make a paste of spinach, mustard green, green chillies and salt. Set aside. Prepare tadka as explained in Insta2 in a microwave oven safe bowl with all the ingredients other than green paste, lime juice and Bengal gram flour. After the beep, remove and add all remaining ingredients, mix well. Place the bowl in the microwave oven. Select Insta 6, enter weight and press start. Serve hot.			

SUKHDI	Insta 6	SUKHDI	200g	400g	600g
		Ingredients:			
		Whole Wheat Flour	2 cup	3 cup	4 cup
		Ghee	1½ cup	2 cup	2½ cup
		Jaggery - Sliced Thinly	1½ cup	2 cup	2½ cup
		Milk	1 cup	1½ cup	2 cup
Method of preparation:					
Take a microwave oven safe glass bowl, add wheat flour and ghee, mix well. to roast the wheat flour select tadka option in Insta 2, enter weight, press start. after beep, remove and add jaggery, milk, mix well. Place the bowl in the microwave oven. Select Insta 6, enter weight and press start. Serve hot.					

PLAIN PALAK CURRY	Insta 6	PLAIN PALAK CURRY	200g	400g	600g
		Ingredients:			
		Palak (Spinach) Finely Chopped	2 cup	2½ cup	3 cups
		Red Chilly Powder	1 tsp	1 tsp	1 tsp
		Moong Dal	¼ cup	½ cup	¾cup
		Garam Masala	1 tsp	1 tsp	1 tsp
		Turmeric Powder	¼ tsp	¼ tsp	½ tsp
		Garlic Paste	¼ tsp	¼ tsp	½ tsp
		Ginger Paste	¼ tsp	¼ tsp	½ tsp
		Oil As Required			
		Salt To Taste			
Method of preparation					
Prepare tadka in a microwave oven safe bowl as explained in Insta 2 with all the ingredients other than palak and salt. After beep, remove, add the remaining ingredients and mix well. Place the bowl in the microwave oven, select Insta 6, enter weight and press start. Remove and serve hot.					

ALOO GOBI MASALA	Insta 6	ALOO GOBI MASALA	200g	400g	600g
		Ingredients;			
		Potatoes cut into cubes	1 cup	1½ cup	2 cup
		Cauliflower florets	1 cup	1½ cup	2 cup
		Onion chopped	1 cup	1½ cup	2 cup
		Red chilli powder	1tsp	1½ tsp	2 tsp
		Turmeric powder	¼ tsp	¼ tsp	½ tsp
		Cumins	½ tsp	1 tsp	1 tsp
		Mustard	¼ tsp	½ tsp	1 tsp
		Chopped green chillies	1tsp	1½ tsp	2 tsp
		Coriander leaves for garnish			
		Oil as required			
		Salt To Taste			
		Method of preparation:			
		Prepare tadka in a microwave oven safe bowl as explained in Insta 2 with all the ingredients other than coriander leaves and salt. After beep, remove; add the all ingredients, mix well. Place the bowl in the microwave oven selects Insta 6, enter weight and press start. Garnish with coriander leaves and Serve hot.			

PANEER MAKHANI	Insta 6	PANEER MAKHANI	200g	400g	600g
		Ingredients:			
		Paneer	200g	400g	600g
		Tomato Puree	1 cup	1½ cup	2 cup
		Fresh Cream	1 cup	1½ cup	2 cup
		Green Chillies	1	2	3
		Red Chilli Powder	1 tsp	1 tsp	1½ tsp
		Garam Masala Powder	1 tsp	1 tsp	1½ tsp
		Dried Kasuri Methi	few	few	few
		Butter As Required			
		Salt To Taste			
		Method of preparation;			
		Prepare tadka in a microwave oven safe bowl as explained in Insta 2 with all the ingredients other than tomato puree and fresh cream. After beep, remove, add the remaining ingredients and mix well. Place the bowl in the microwave oven, select Insta 6, enter weight and press start. Remove, and serve hot.			

COCONUT LADOO	Insta 6	COCONUT LADOO	200g	400g	600g
		Ingredients:			
		Suji / Rava	1 cup	2 cup	3 cup
		Grated Coconut	1½ cup	3 cup	4 cup
		Condensed Milk	as required	as required	as required
		Powdered Sugar	1 cup	2 cup	3 cup
		Dry Coconut Powder	½ cup	¾ cup	1 cup
		Method of preparation;			
		Take suji (rava) in a microwave oven safe glass bowl. Place in the microwave oven, select Insta 2, enter weight & press start. After beep, remove, add grated coconut, condensed milk, powdered sugar & mix well. Select Insta 6, enter weight, and press start. Remove after beep & set aside to cool. Make small balls of the mixture. Roll the balls in dry coconut powder & serve.			

BANANA HALWA	Insta 6	BANANA HALWA	200g	400g	600g
		Ingredients:			
		Banana Ground To Paste	2 cup	2½ cup	3 cups
		Wheat Flour	¾ cup	1 cup	1½ cup
		Milk	¾ cup	1 cup	1½ cup
		Cardamom Powder	a pinch	a pinch	a pinch
		Sugar	1 cup	1½ cup	2 cup
		Cashews	few	few	few
		Almonds	few	few	few
		Ghee As Required			
		Method of preparation			
		Prepare tadka in a microwave oven safe bowl as explained in Insta 2 with wheat flour and ghee. After beep, remove, add the remaining ingredients and mix well. Place the bowl in the microwave oven, select Insta 6, enter weight and press start. Remove and serve hot.			

LAUKI SABZI	Insta 6	LAUKI SABZI	200g	400g	600g
		Ingredients:			
		Lauki (Peel The Skin & Cut Into Pieces)	200g	400g	600g
		Peas	1 tbsp	1½ tbsp	2 tbsp
		Chopped Capsicum	1	1	1½
		Chopped Onion	1	2	2
		Chopped Green Chilli	2	2	3
		Yogurt	1 tbsp	1½ tbsp	2 tbsp
		Crushed Ginger	½ inch	¾ inch	1 inch
		Garam Masala	1 tsp	1½ tsp	2 tsp
		Turmeric Powder	½ tsp	¾ tsp	1 tsp
		Red Chilli Powder	1 tsp	1½ tsp	2 tsp
		Oil	1 tbsp	1 tbsp	1½ tbsp
		Chopped Coriander For Garnish			
		Salt To Taste			
		Water			
Method of preparation					
Prepare tadka in a microwave oven safe bowl as explained in Insta 2 with all the ingredients other than peas, capsicum, yogurt and coriander. After beep, remove, add the remaining ingredients other than coriander and mix well. Place the bowl in the microwave oven, select Insta 6, enter weight and press start. Remove and serve hot.					

SEVIYA KHEER	Insta 6	SEVIYA KHEER	200g	400g	600g
		Ingredients:			
		Seviya (Vermicelli) Roasted	2 cup	3 cup	4 cup
		Milk	4 cup	6 cup	8 cup
		Condensed Milk	1 cup	1½ cup	2 cup
		Sugar	1 cup	1½ cup	2 cup
		Raisins	½ tbsp	1 tbsp	1½ tbsp
		Cashew Nut Pieces (Roasted)	1 tbsp	1 tbsp	1½ tbsp
		Almonds (Roasted)	1tbsp	1tbsp	1½ tbsp
		Powdered Elaichi (Cardamom)	½ tsp	½ tsp	1 tsp
		Water As Required			
Method of preparation					
Take a microwave oven safe bowl; add all the ingredients except elaichi powder and raisins and mix well. Place the bowl in the microwave oven, select Insta 6, enter weight and press start. Remove; add elaichi powder and raisins mix well. Serve hot.					

DRUM STICK LEAVES CURRY	Insta 6	DRUMSTICK LEAVES CURRY	200g	400g	600g
	Ingredients:				
	Drum Stick Leaves		2 cup	3 cup	4 cup
	Coconut Grated		1 tbsp	1 tbsp	1½ tbsp
	Masoor Dal		1 tbsp	1 tbsp	1½ tbsp
	Cumins Seeds		½ tsp	½ tsp	1 tsp
	Mustard Seeds		½ tsp	½ tsp	1 tsp
	Red Chilli Powder		1 tsp	1½ tsp	2 tsp
	Turmeric Powder		¼ tsp	¼ tsp	½ tsp
	Oil As Required				
	Salt To Taste				
	Method of preparation				
Prepare tadka in a microwave oven safe bowl as explained in Insta 2 with all the ingredients other than drumstick leaves. After beep, remove, add the drumstick leaves and mix well. Place the bowl in the microwave oven, select Insta 6, enter weight and press start. Remove and serve hot.					

SHEERA	Insta 6	SHEERA	200g	400g	600g
	Ingredients:				
	Suji - Roasted		1 cup	1½ cup	2 cup
	Milk		1 cup	1½ cup	2 cup
	Sugar		1 cup	1½ cup	2 cup
	Ghee		1 tbsp	1½ tbsp	2 tbsp
	Cardamom Powder		a pinch	a pinch	a pinch
	Cashews		4	5	6
	Almonds		4	5	6
	Raisins		few	few	few
	Water As Required				
	Method of preparation				
Take a microwave oven safe bowl; add all ingredients and mix well. Place the bowl in the microwave oven, select Insta 6, enter weight and press start. Add water if required. Stir twice in between for better result. PN - Suji can be roasted by placing it on plain paper in the microwave oven and cooking it in microwave mode for 3 - 4 min. Mix twice in between					

TOMATO CURRY	Insta 6	TOMATO CURRY	200g	400g	600g
		Ingredients:			
		Tomatoes, Finely Chopped	200g	400g	600g
		Red Chilli Powder	1 cup	1½ cup	2 cup
		Onions, Finely Chopped	1 cup	1½ cup	2 cup
		Garlic, Slightly Crushed	2	3	4
		Mustard Seeds	½ tsp	½ tsp	1 tsp
		Turmeric Powder	¼ tsp	¼ tsp	½ tsp
		Curry Leaves	few	few	few
		Jaggery	a pinch	a pinch	a pinch
		Coriander Powder	½ tsp	½ tsp	1 tsp
		Oil As Required			
		Salt To Taste			
		Coriander Leaves For Garnish			
Method of preparation					
Prepare tadka in a microwave oven safe bowl as explained in Insta 2 with all the ingredients other than tomatoes, jaggery and coriander leaves. After beep, remove, add all the ingredients other than coriander leave and mix well. Place the bowl in the microwave oven, select Insta 6, enter weight and press start. Remove and garnish with coriander leaves. Serve hot.					

TAMARIND RICE	Insta 6	TAMARIND RICE	200g	400g	600g
		Ingredients:			
		Cooked Rice	1 cup	1½ cup	2 cup
		Tamarind Juice	¼ cup	½ cup	¾ cup
		Channa Dal	1 tsp	1½ tsp	2 tsp
		Dried Red Chilly	3	4	4
		Turmeric Powder	¼ tsp	½ tsp	¾ tsp
		Curry Leaves	few	few	Few
		Jaggery Powder	½ tsp	¾ tsp	1 tsp
		Fenugreek	½ tsp	¾ tsp	1 tsp
		Hing	a pinch	a pinch	a pinch
		Mustard	½ tsp	¾ tsp	1 tsp
		Sesame Oil	1 tbsp	1 tbsp	1½ tbsp
		Peanuts	few	few	Few
		Salt To Taste			
Method of preparation					
Prepare tadka in a microwave oven safe bowl as explained in Insta 2 with all the ingredients other than cooked rice and tamarind juice. After beep, remove, add the all ingredients and mix well. Place the bowl in the microwave oven, select Insta 6, enter weight and press start. Remove and serve hot.					

BABY CORN MASALA	Insta 6	BABY CORN MASALA	200g	400g	600g
		Ingredients:			
		Baby Corn	200g	400g	600g
		Tomatoes Chopped	1 cup	1½ cup	2 cup
		Onion Chopped	1 cup	1½ cup	2 cup
		Roasted Groundnut Powder	¼ cup	½ cup	¾ cup
		Chilli Powder	1 tsp	1½ tsp	2 tsp
		Turmeric Powder	¼ tsp	¼ tsp	½ tsp
		Mustard Seeds	½ tsp	¾ tsp	1 tsp
		Cumin Seeds	1 tsp	1½ tsp	2 tsp
		Fenugreek Seeds	1 tsp	1½ tsp	2 tsp
		Saunf	1 tsp	1½ tsp	2 tsp
		Salt To Taste			
		Oil As Required			
		Coriander Leaves For Garnish			
Method of preparation					
Prepare tadka in a microwave oven safe bowl as explained in Insta 2 with all the ingredients other than baby corn, tomatoes and coriander leaves. After beep, remove, add the all ingredients other than coriander leaves and mix well. Place the bowl in the microwave oven, select Insta 6, enter weight and press start. Remove, garnish with coriander leaves and serve hot.					

BEET ROOT RASAM	Insta 6	BEET ROOT RASAM	200g	400g	600g
		Ingredients:			
		Beetroot chopped	200g	400g	600g
		Tamarind juice	1 cup	1½ cup	2 cup
		Urad Dal	200g	400g	600g
		Garlic paste	½ tsp	¾ tsp	1 tsp
		Cilantro Sprigs	¼ cup	½ cup	¾ cup
		Mustard Seeds	½ tsp	¾ tsp	1 tsp
		Cumin Seeds	½ tsp	¾ tsp	1 tsp
		Curry Leaves	few	few	few
		Oil as required			
		Salt to taste			
Method of preparation					
Prepare tadka in a microwave oven safe bowl as explained in Insta 3 with all the ingredients other than beetroot and tamarind juice. After beep, remove, add the all ingredients and mix well. Place the bowl in the microwave oven selects Insta 6, enter weight and press start. Remove, and serve hot.					

POTATO CURRY	Insta 6	POTATO CURRY	200g	400g	600g
		Ingredients:			
		Potato cut into cubes	2 cup	3 cup	4 cup
		Tomato puree	1 cup	1½ cup	2 cup
		Onion chopped	1 cup	1½ cup	2 cup
		Green Chile chopped	2	3	4
		Red Chile Powder	1 tsp	1½ tsp	2 tsp
		Turmeric Powder	¼ tsp	¼ tsp	¼ tsp
		Mustard Seeds	½ tsp	¾ tsp	1 tsp
		Cumin Seeds	½ tsp	¾ tsp	1 tsp
		Curry leaves	few	few	few
		Salt to Taste			
		Oil as required			
Method of preparation					
Prepare tadka in a microwave oven safe bowl as explained in Insta 2 with all the ingredients other than potato and tomato puree. After beep, remove, add the all ingredients and mix well. Place the bowl in the microwave oven selects Insta 6, enter weight and press start. Remove, and serve hot.					

METHI CHUTNEY	Insta 6	METHI CHUTNEY	200g	400g	600g
		Ingredients:			
		methi leaves	3 cups	4 cup	5 cup
		sesame seeds	¼ cup	½ cup	¾ cup
		urad dal	2 tsp	3 tsp	4 tsp
		dried red chillies	6	8	10
		tamarind juice	¼ cup	½ cup	¾ cup
		salt to taste			
		peanut oil as required			
Method of preparation					
Take a microwave oven safe bowl, add all the ingredients and mix well. Place the bowl in the microwave oven selects Insta 6, enter weight and press start. Remove, set to cool and blend the mixture into a smooth paste.					

DUM ALOO	Insta 6	DUM ALOO	200g	400g	600g
		Ingredients:			
		aloo (potatoes)	200g	400g	600g
		tomato puree	1 cup	1½ cup	2 cup
		curd	½ cup	1 cup	1½ cup
		ghee as required			
		Spices	2	3	4
		bay leaves	1	2	3
		black peppercorns	4	5	6
		green cardamoms	2	3	4
		brown cardamom	2	3	4
		cinnamon stick	1	2	3
		Paste			
		onion (chopped)	1	2	3
		flakes garlic	3	4	6
		ginger	¼" inch	½" inch	½" inch
		black peppercorns	4	5	6
		poppy seeds	½ tsp	½ tsp	1 tsp
		coriander seeds	½ tsp	½ tsp	1 tsp
		cumin seeds	½ tsp	½ tsp	1 tsp
		dry red chillies	2	3	4
		turmeric powder	¼ tsp	¼ tsp	½ tsp
		ground mace	a pinch	a pinch	a pinch
		ground nutmeg	a pinch	a pinch	a pinch
		salt to taste			
		Method of preparation			
		Prepare tadka in a microwave oven safe bowl as explained in Insta 2 with all the ingredients other than palak and paneer. After beep, remove, add all the ingredients and mix well. Place the bowl in the microwave oven selects Insta 6, enter weight and press start. Serve hot.			

EGG KURMA	Insta 6	EGG KURMA	200g	400g	600g
		Ingredients:			
		beaten eggs	3	4	5
		grated coconut	½ cup	¾ cup	1 cup
		onion, chopped	½ cup	¾ cup	1 cup
		milk	2 tbsp	2 tbsp	3 tbsp
		cashew nuts	2 tbsp	2 tbsp	3 tbsp
		green chillies, chopped	2	3	4
		coriander powder	1 tsp	1½ tsp	2 tsp
		cloves	2	3	4
		cinnamon	2	3	4
		cardamoms	1 stick	2 stick	3 stick
		ginger paste	½ tsp	¾ tsp	1 tsp
		turmeric powder	¼ tsp	¼ tsp	½ tsp
		ghee as required			
		salt to taste			
Method of preparation					
Prepare tadka in a microwave oven safe bowl as explained in Insta 2 with all the ingredients other than egg and milk. After beep, remove, add the all ingredients and mix well. Place the bowl in the microwave oven selects Insta 6, enter weight and press start. Remove, and serve hot.					

PRAWNS VINDALOO	Insta 6	PRAWNS VINDALOO	200g	400g	600g
		Ingredients:			
		Shelled Prawns	200g	400g	600g
		Tomatoes, Chopped	1 cup	1½ cup	2 cup
		Cumin Seeds	½ tsp	¾ tsp	1 tsp
		Ginger, Garlic Paste	1 tsp	1½ tsp	2 tsp
		Curry Leaves	few	few	few
		Chilli Powder	1 tsp	1½ tsp	2 tsp
		Turmeric Powder	¼ tsp	¼ tsp	½ tsp
		Vinegar	1 tbsp	1 tbsp	1½ tbsp
		Corn Flour	1 tbsp	1 tbsp	1½ tbsp
		Sugar	1 tsp	1½ tsp	2 tsp
		Salt To Taste			
Method of preparation					
Prepare tadka in a microwave oven safe bowl as explained in Insta 2 with all the ingredients other than prawns, tomato and vinegar. After beep, remove, add the remaining ingredients and mix well. Place the bowl in the microwave oven, select Insta 6, enter weight and press start. Remove and serve hot.					

PRAWNS MASALA	Insta 6	PRAWNS MASALA	200g	400g	600g
		Ingredients:			
		Prawn – Shelled	200g	400g	600g
		Onions Cut Into Small Pieces	1	2	3
		Garlic Paste	¼ tsp	½ tsp	1 tsp
		Ginger Paste	¼ tsp	½ tsp	1 tsp
		Chilli Powder	1 tsp	1½ tsp	2 tsp
		Turmeric Powder	¼ tsp	¼ tsp	½ tsp
		Mustard Seeds	¼ tsp	½ tsp	1 tsp
		Oil As Required			
		Salt To Taste			
Method of preparation;					
Prepare tadka in a microwave oven safe glass bowl as explained in Insta 2 with all the ingredients other than the prawns. Remove, add the prawns and mix well. Place the bowl in the microwave oven, enter Insta 6, enter weight and press start. Remove and serve hot.					

POMFRET FRY	Insta 6	POMFRET FRY	200g	400g	600g
		Ingredients:			
		Pomfret - washed and cleaned	200g	400g	600g
		garlic	½ tsp	½ tsp	1 tsp
		lemon juice	1tsp	1½ tsp	2 tsp
		chilli powder	1tsp	1½ tsp	2 tsp
		turmeric powder	¼ tsp	¼ tsp	½ tsp
		pepper powder	1tsp	1½ tsp	2 tsp
		garam masala	1tsp	1½ tsp	2 tsp
		rice flour	½ tbsp	1tbsp	1 tbsp
		oil as required			
		salt to taste			
Method of preparation					
Mix all the ingredients other than Pomfret to make a paste. Toss the fish into it and apply evenly on all sides. Set aside for 1 hr. Arrange the marinated fish in a flat base glass bowl. Place the bowl in the microwave oven, select Insta 6, enter weight and press start. Remove and serve.					

MACHER JHOL	Insta 6	MACHER JHOL	200g	400g	600g
		Ingredients:			
		Fish Rohu	200g	400g	600g
		Potatoes	2	4	6
		Onion Paste	½ cup	1 cup	1½ cup
		Green Chillies	2	3	4
		Coriander Seeds	1 tsp	1½ tsp	2 tsp
		Cumin Seeds	1 tsp	1½ tsp	2 tsp
		Turmeric Powder	¼ tsp	¼ tsp	½ tsp
		Chilli Powder	1 tsp	1½ tsp	2 tsp
		Oil			
		Salt To Taste			
Method of preparation:					
Marinate fish with turmeric powder and salt for 20 minutes and wash it well. Prepare tadka in a microwave oven safe bowl as explained in Insta 2 with all the ingredients other than fish. After beep, remove, add the remaining ingredients, mix smoothly. Place the bowl in the microwave oven, select Insta 6, enter weight and press start.					

MACHE BESARA	Insta 6	MACHE BESARA	200g	400g	600g
		Ingredients:			
		fish (rohu or any fresh water fish)	200g	400g	600g
		potato (cut into cubes)	1	2	2
		curd	1cup	2 cup	2 cup
		green chillies paste	4	5	6
		mustard paste	1tbsp	1½ tbsp	2 tbsp
		garlic cloves paste	2	3	4
		turmeric powder	¼ tsp	½ tsp	¾ tsp
		cumin seeds	1 tsp	1½ tsp	2 tsp
		mustard seeds	1 tbsp	1 tbsp	1½ tbsp
		fennel seeds	1 tsp	1½ tsp	2 tsp
		fénugreek seeds	1 tsp	1½ tsp	2 tsp
		kale jeera seeds	1 tsp	1½ tsp	2 tsp
		oil as required			
		salt to taste			
		coriander leaves for garnish			
Method of preparation					
Prepare tadka in a microwave oven safe bowl as explained in Insta 2 with all the ingredients other than fish, curd and coriander leaves. After beep, remove; add all the ingredients other than coriander leaves and mix smoothly. Place the bowl in the microwave oven selects Insta 6, enter weight and press start. Remove, garnish with coriander leaves and serve hot.					

DOI MACHCH	Insta 6	DOI MACHCH	200g	400g	600g
		Ingredients:			
		Fish (Rohu)-sliced & rubbed with turmeric & salt	200g	400g	600g
		Curd	1 cup	1½ cup	2 cup
		Onion paste	1 cup	1½ cup	2 cup
		Garlic paste	½ tsp	¾ tsp	1 tsp
		Ginger paste	½ tsp	¾ tsp	1 tsp
		Turmeric powder	¼ tsp	¼ tsp	½ tsp
		Chilli powder	1 tsp	1½ tsp	2 tsp
		Bay leaves	2	2	3
		Cumin seeds	½ tsp	¾ tsp	1 tsp
		Cardamoms	3	4	5
		Cloves	2	3	4
		Cinnamon-broken	1	2	3
		Sugar	1 tsp	1½ tsp	2 tsp
		Oil as required			
		Salt to taste			
		Method of preparation			
		Prepare tadka in a microwave oven safe bowl as explained in Insta 2 with fish. After beep, remove; add all the ingredients mix smoothly. Place the bowl in the microwave oven selects Insta 6, enter weight and press start. Serve hot.			

FISH CURRY	Insta 6	FISH CURRY	200g	400g	600g
		Ingredients:			
		Fish - Washed & Sliced	200g	400g	600g
		Coriander Leaves – Chopped	1 tbsp	1½ tbsp	2 tbsp
		Tomatoes - Finely Chopped	2	2	3
		Garlic Cloves	5	6	7
		Green Chillies – Chopped	2	3	4
		Methi Seeds	1 tsp	1½ tsp	2 tsp
		Coriander Powder	1 tsp	1½ tsp	1½ tsp
		Turmeric Powder	¼ tsp	½ tsp	½ tsp
		Salt To Taste			
		Oil As Required			
		Method of preparation:			
		Marinate the fish in salt and turmeric powder for 15 minutes. Grind the coriander leaves, garlic and green chillies into a paste. Prepare tadka as explained in Insta 2 with all the ingredients other than the fish and above mentioned paste. Remove, add fish & coriander, green chilli, garlic paste to the tadka and mix smoothly. Place the bowl in the microwave oven, select Insta 6, enter weight and press start. Remove and serve hot.			

MISA MACH PORA	Insta 6	MISA MACH PORA	200g	400g	600g
		Ingredients:			
		Shrimps, Shelled	2 cup	3 cup	4 cup
		Ground Coriander	1½ tsp	2 tsp	3 tsp
		Lime Juice	2 tsp	3 tsp	3 tsp
		Onion, Chopped	½ cup	1 cup	1½ cup
		Peppercorns	few	few	few
		Turmeric Powder	a pinch	a pinch	a pinch
		Salt To Taste			
		Oil As Required			
		Method of preparation:			
		Rub salt and turmeric powder on the shelled shrimps. Marinate for 20 minutes. Prepare tadka as explained in Insta 2 in a microwave oven safe bowl with all the ingredients other than marinated shrimps and lime juice. After the beep, remove and add all remaining ingredients, mix well. Place the bowl in the microwave oven. Select Insta 6, enter weight and press start. Serve hot.			

MUTTON LIVER CURRY	Insta 6	MUTTON LIVER CURRY	200g	400g	600g
		Ingredients:			
		Goat Liver	200g	400g	600g
		Onion Finely Sliced	1	2	3
		Ginger & Garlic Paste	½ tsp	1 tsp	1½ tsp
		Tomato Puree	½ cup	½ cup	1 cup
		Turmeric	¼ tsp	¼ tsp	½ tsp
		Red Chilli Powder	1 tsp	1½ tsp	2 tsp
		Coriander Powder	1 tsp	1½ tsp	2 tsp
		Cumin Powder	1 tsp	1½ tsp	2 tsp
		Garam Masala Powder	1 tsp	1½ tsp	2 tsp
		Ghee	½ tbsp	½ tbsp	1 tbsp
		Bay Leaves	2	3	4
		Cinnamon	1" stick	2" stick	3" stick
		Green Cardamom	3	4	6
		Cloves	3	4	6
		Coriander Leaves For Garnish			
		Water As Required			
		Salt To Taste			
		Method of preparation;			
		Prepare tadka in a microwave oven safe glass bowl as explained in Insta 2 with all the ingredients other than liver, tomato puree, coriander leaves and water. Remove, add the remaining ingredients other than coriander leaf and mix well. Place the bowl in the microwave oven, select Insta 6, enter weight and press start. Remove, garnish with coriander leaves and serve.			

CAULIFLOWER ONION FRY	Insta 6	CAULIFLOWER ONION FRY	200g	400g	600g
		Ingredients:			
		Cauliflower Florets	200g	400g	600g
		Onion Chopped	1	2	3
		Green Chillies	2	3	4
		Coriander Powder	2 tsp	3 tsp	4 tsp
		Lemon Juice	1 tsp	2 tsp	2 tsp
		Turmeric Powder	¼ tsp	¼ tsp	½ tsp
		Mustard Seeds	¼ tsp	½ tsp	½ tsp
		Cumin Seeds	½ tsp	1 tsp	1 tsp
		Curry Leaves	few	few	few
		Oil As Required			
		Salt To Taste			
		Method of preparation:			
		Prepare tadka as explained in Insta 2 in a microwave oven safe glass bowl with all the ingredients other than cauliflower florets and salt. After the beep, remove and add all remaining ingredients, mix well. Place the bowl in the microwave oven. Select Insta 6, enter weight and press start. Serve hot.			

BEEETROOT PORIYAL	Insta 6	BEEETROOT PORIYAL	200g	400g	600g
		Ingredients			
		Beetroot - (chopped or grated)	1 big	1 1/2 big	2 big
		Grated coconut	1 tblsp	2 tblsp	3 tblsp
		Red Chilly Powder	1 tsp	1 tsp	2 tsp
		Oil	1 tblsp	2 tblsp	3 tblsp
		Mustard seeds	1 tsp	1 tsp	2 tsp
		Urad dal	1 tsp	2 tsp	2 tsp
		Dry Red Chillies - 2	2	2	3
		Asafoetida (Hing)	a pinch	a pinch	a pinch
		Curry leaves	few	few	few
		Salt - to taste			
		Method of preparation:-			
		Take a microwave oven safe bowl, add all Tadka ingredients other than beet root, select insta 2, enter weight and press start. After beep, Remove and add Beetroot, mix well and select Insta 6, enter weight, press start. Serve hot.			
		Method of preparation			
		Cut the top of tomato like a cap. Gently scoop out the center. Keep aside. Prepare tadka in a microwave oven safe bowl as explained in Insta 2 with all the ingredients other than tomato, grated cheese and coriander leaves. After beep, remove, fill all the ingredients into tomatoes other than coriander leaves and mix well. Place the tomatoes in a flat glass bowl, select Insta 6, enter weight and press start. Remove, garnish with coriander leaves and serve hot.			

STUFFED TOMATOES	Insta 7	STUFFED TOMATOES	200g	400g
		Ingredients:		
		Tomatoes	200 gms	400 gms
		Paneer grated	1½ cup	2 cup
		Onion finely chopped	1½ cup	2 cup
		Green chili (finely chopped)	2	3
		Red chili powder to taste.	1½ tsp	2 tsp
		Gram Masala to taste	1½ tsp	2 tsp
		Turmeric powder	¼ tsp	½ tsp
		Grated cheese	½ cup	¾ cup
		Coriander leaves for garnish		
		Oil as required		
		Salt to taste		
		Method of preparation		
		Cut the top of tomato like a cap. Gently scoop out the centres. Keep aside.		
		Prepare tadka in a microwave oven safe bowl as explained in Insta 2 with all the ingredients other than tomato, grated cheese and coriander leaves. After beep, remove, fill all the ingredients into tomatoes other than coriander leaves and mix well. Place the tomatoes in a flat glass bowl, select Insta 7, enter weight and press start. Remove, garnish with coriander leaves and serve hot.		

STUFFED CAPSICUM	Insta 7	STUFFED CAPSICUM	200g	400g
		Ingredients:		
		Tomatoes	200 gms	400 gms
		Paneer grated	1½ cup	2 cup
		Onion finely chopped	1½ cup	2 cup
		Green chilli (finely chopped)	2	3
		Red chilli powder to taste.	1½ tsp	2 tsp
		Gram Masala to taste	1½ tsp	2 tsp
		Turmeric powder	¼ tsp	½ tsp
		Grated cheese	½ cup	¾ cup
		Coriander leaves for garnish		
		Oil as required		
		Salt to taste		
		Method of preparation		
		Cut the top of Capsicum like a cap. Gently scoop out the centres. Keep aside.		
		Prepare tadka in a microwave oven safe bowl as explained in Insta 2 with all the ingredients other than capsicum, grated cheese and coriander leaves. After beep, remove, fill all the ingredients into capsicum other than coriander leaves and mix well. Place the capsicum in a flat glass bowl, select Insta 7, enter weight and press start. Remove, garnish with coriander leaves and serve hot.		

TOMATO SOUP	Insta 8	TOMATO SOUP	200ml	400ml
		Ingredients:		
		Tomatoes - Large	2	4
		Mint Leaves	Few	few
		Pepper To Taste		
		Salt To Taste		
		Method of preparation:		
Take a microwave oven safe bowl; add salt, pepper, tomatoes, mix well and select Insta 2, enter weight & press start. Remove after beep, add mint leaves, mix well and select Insta 8, set weight, press start. When cool, blend the tomatoes in a mixer. Strain and serve hot.				

MILK PUDDING	Insta 8	MILK PUDDING	200ml	400ml
		Ingredients:		
		Ground Rice	2 cups	3 cups
		Milk	2 cups	3 cups
		Granulated Sugar	1 cup	1½ cup
		Melted Butter Or Ghee	1 tbsp	1½ tbsp
		Rose Water	1 tsp	1½ tsp
		Ground Cardamom	¼ tsp	¼ tsp
		Almonds	few	Few
		Pistachio Nuts	few	Few
Method of preparation				
Take a microwave oven safe bowl add ghee or butter, ground rice, select Insta 2, enter weight, press start. After beep, remove; add the remaining ingredients other than almonds and pistachio, mix well. Place the bowl in the microwave oven, select Insta 8, enter weight and press start. Remove, garnish with almonds and pistachio and serve.				

PITLA	Insta 8	PITLA	200ml	400ml
		Ingredients:		
		besan	1cup	2 cup
		chopped tomato	1	2
		chopped coriander leaves	½ tbsp	1 tbsp
		chopped onion	1	2
		curry leaves	few	few
		hing	a pinch	a pinch
		mustard seeds	¼ tsp	¼ tsp
		cumin's powder	1 tsp	1 tsp
		coriander powder	1 tsp	1 tsp
		lemon juice / tamarind juice	½ tbsp	1 tbsp
		red chilli powder	1tsp	1½ tsp
		turmeric powder	¼ tsp	¼ tsp
		salt to taste		
Method of preparation				
Prepare tadka in a microwave oven safe bowl as explained in Insta 2 with all the ingredients other than besan, tamarind juice and coriander. Remove, add the remaining ingredients other than the coriander and mix well. Place the bowl in the microwave oven selects Insta 8, enter weight and press start. Remove, garnish with coriander leaves and serve.				

MILK BOILING	Insta 8	MILK BOILLING	200ml	400ml
		Ingredients		
		Milk	200ml	400ml
Method of preparation:-				
Take Milk in to a microwave oven safe bowl and place it in the oven, select insta 8, enter weight and press start. Serve hot.				

MICROWAVE OVEN WARRANTY

The Godrej Microwave Oven comes with a **THREE** years Warranty on the magnetron and a **ONE** year warranty (except for plastic parts, glass components and decorative stripes, knobs etc.) against defective material or workmanship on all components of the microwave oven. Godrej & Boyce Mfg. Co. Ltd. Appliance Division undertakes repairs, free of charge during the warranty period.

INSTRUCTIONS FOR THE CUSTOMER

1. Kindly ensure that the dealer fills the warranty details correctly and completely.
2. You should retain the warranty page for record and produce the same in the event of any warranty repairs.
3. In the event of a defect developing in the product, contact the nearest authorised Godrej & Boyce Service Centre for obtaining warranty service and inform the defect, model details and Serial No.

TERMS AND CONDITIONS

1. Repairs and replacement of parts will be earned out through the authorised customer service centre.
2. For units installed beyond the municipal limits of the jurisdiction of the authorised customer care centre all expenses incurred in collecting the units or parts thereof from the company's customer care centre, as well as expenses incurred with depositing of service personnel/technician's towards conveyance and other incidents will be borne by the customer.
3. The concerned customer care centre will advise the customer whether to effect the repair at site or at the customer care centre.
4. While the company will make every effort to carry out the repairs at the earliest, it however is made expressly clear that the company is under no obligation to do so in a specified period of time.
5. The company or its authorised customer care centre/service dealer reserves the right to retain any parts, components replaced at its discretion.
6. Warranty does not cover accessories to the equipment.
7. The warranty is confined to the first purchaser of MWO only and non-transferable.
8. Call registered with the centralised helpline/authorised service centre, where in only cleaning of the unit/parts in the unit due to dust accumulation on portions of the units are not to be considered as defects.
9. In case of any damages to the product, customer abuse, repairs by unauthorised personnel & misuse detected by the authorised service centre personnel, the warranty conditions are not applicable.
10. If any coloured internal or external components are replaced, effort will be made to ensure that the shades match with the original or other components. However, the replaced shades, pattern, tints may vary from the customer's unit due to usage of the unit. Any matching components changed at customer's request will be charged, except the component which is actually needed.
11. The unit shall be operated with variation $\pm 5\%$ of the rated voltage. Fluctuation beyond specified tolerance will not be covered under warranty. Customer shall not operate the product below 210V under any circumstances.
12. Parts not covered - Main door, Glass, Bulb, Rubber, Plastic Components.
13. This warranty does not cover any type of painting, plating including rusting etc. or defects thereof.
14. The product must be maintained to keep hygiene. Any insects, rodents their causing obstruction to functioning the product, company is not responsible and In turn warranty stands terminated.

Godrej & Boyce Mfg. Co. Ltd. - Appliance Division

MODEL NO.

WARRANTY DETAILS

UNIT SR. NO.

UNIT SR. NO.

CUSTOMER'S NAME & ADDRESS _____ _____ _____ TEL. _____

DEALER'S NAME & ADDRESS _____ _____ _____ TEL. _____

Customer's Signature:

Dealer's Signature:

This card is valid only if it is filled in and stamped by our authorised dealer on the date of purchase.

Warranty is Void If:

1. The warranty card is not completed properly at the time of purchase.
2. The completed warranty card is not presented to the authorised personnel at the time of service of the product.
3. The microwave is not operated according to instructions given in the 'User Guide'.
4. Defects are caused by improper or reckless use, which shall be determined by the company personnel.
5. Any repair work earned out by persons other than authorised company personnel.
6. Defects caused beyond control like abnormal voltage, acts of God, or while in transit to service centre or purchaser's residence.
7. The warranty is not valid in case the serial number is deleted, defaced or altered.
8. Damage to the microwave or any parts due to transportation or shifting is not covered by the warranty.
9. The warranty automatically expires after 12 month of original date of purchase, even if the microwave may not be in use for any time for whatever reasons during the warranty period.

BRANCH ADDRESSES / SERVICE CONNECT

For any further assistance, please contact our nearest branch office or service centre:

Branch	Branch Addresses	Service Connect
Ahmedabad	4 th Floor, APM Shopping Mall Near IOCL Petrol Pump, Shyamal-Karnavati 100 Ft. Road, Satellite, Ahmedabad - 380 015.	<p style="text-align: center;">Call • 1800-209-5511 (Toll-Free)</p>
Bangalore	3 rd Floor, The Karnataka Film Chamber of Commerce Bldg. 28, 1st Main, Crescent Road, High Grounds Nr. Shivanand Circle, Bangalore - 560 001.	
Bhopal	217, Zone I, M.P. Nagar, Beh. Jyoti Talkies, Bhopal - 462 011.	
Bhubaneswar	Highway Complex NH-5, Rudrapur, Bhubaneswar - 752 101.	
Chandigarh / Mohali	Plot No.A-40, Phase-VIII-A, Industrial Area, Mohali - 160059.	
Chennai	No.1, Sidco Industrial Estate. Ambattur, Chennai - 600 098.	
Coimbatore	585-590, Sathya Towers 3 rd floor, D.B. Road R.S. Puram, Coimbatore - 641 002.	
Delhi	Godrej Bhavan, 2 nd Floor, Shershah Suri Marg, Okhla, New Delhi - 110 065.	
Faridabad	Godrej Bhavan, 2 nd Floor, Shershah Suri Marg, Okhla, New Delhi - 110 065.	
Ghaziabad	Godrej Bhavan, 2 nd Floor, Shershah Suri Marg, Okhla, New Delhi - 110 065.	
Guwahati	Godrej Building, G.S.Road, Ulubari, Flyover, Guwahati - 781 007.	
Hyderabad	201 & 202, Lala-1 Land Mark, 5-4-94 to 97, 2nd Floor, Above Digital Shoppo, Ranigunj, M.G. Road, Secunderabad - 500 003.	
Jaipur	502-506, 5 th Floor, Gaurav Towers, Malviya Nagar, Jaipur-302 017.	
Kochi	2 nd Floor, Angels' Arcade South Kalamassery, Near CUSAT Signal Ernakulam - 682022.	
Kolkata	Block GN, Sector V, Salt lake, Kolkata - 700 091.	
Lucknow	C 3/3 & C3/4, Sanjay Complex Behind Akashwani Bhawan, Vidhan Sabha Marg Lucknow - 226001.	
Mumbai	Appliance Divn., Plant 4, Pirojshanagar, Vikhroli, Mumbai - 400079.	
Nagpur	Dr. Bhiwapurkar Chamber 2nd Floor, Opp: Yashwant Stadium Dhantoli, Nagpur - 440012.	
Patna	Jeevan Deep Bldg. Exhibition Road, Patna - 800 001.	
Pune	Apollo Building Square, Plot No.60, Survey No.599 Sahaney Sujan Park, Lullanagar, Bibewadi Road, Pune - 411 040.	
Raipur	9/1, Besides Bharat Petrol Pump Opp: Hotel Picadelly, Mahoba Bazaar, GE Road, Raipur - 492001.	
Ranchi	C/o. Surya Motors, Near Krishi Bazaar Samiti Pandra, Ranchi (Jharkhand) - 835 222.	

Website: www.godrejappliances.com & www.smartcare@godrej.com
E-mail: smartcare@godrej.com

Protection of Environment:

Protection of environment" is one of the core values of Godrej and we seek your co-operation to make sure that the product, packaging and plastic material is not disposed as unsorted municipal waste.



This symbol is known as the "Crossed-out Wheellie Bin Symbol". It means that the product should not be disposed of with your general house-hold waste.

It should be disposed of only through the company's collection points with special treatment so as to prevent any damage to the environment. Please call: **1800 209 5511** for applicable buy back arrangement or **visit: www.godrejappliances.com/green-think** for details about Godrej Appliances authorised collection points.

Godrej | APPLIANCES