

Godrej

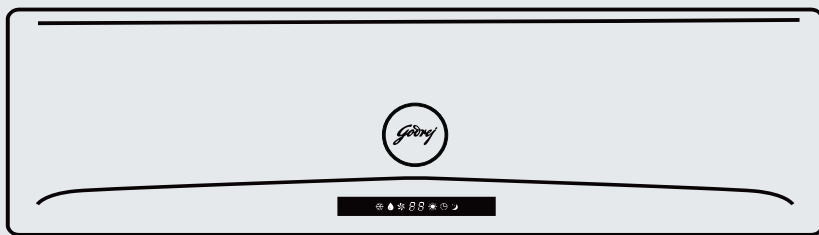

Split Air Conditioner
Wall - mounted

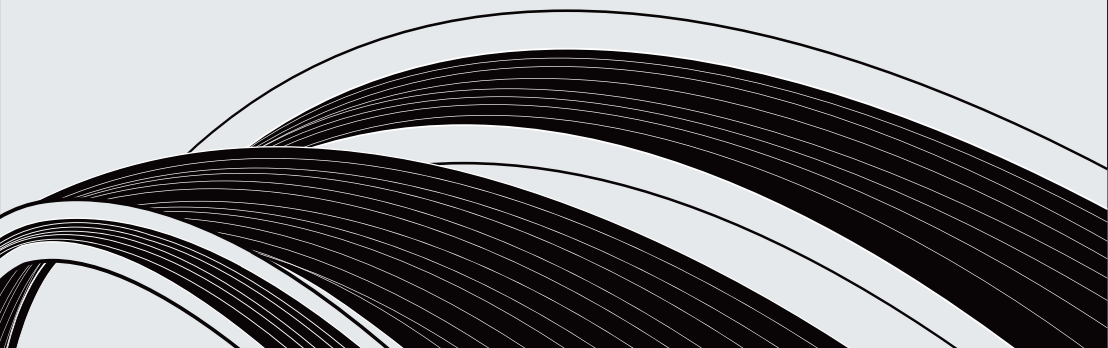

OWNER'S MANUAL

Dear Customer,

On behalf of Godrej Appliances, we welcome you to the Godrej family, and thank you for giving us an opportunity to serve you.

Godrej Appliances is a leading brand not just in technology and performance but also for its excellent customer service, we have more than 660 service centers across India, so that we can be close to our customers and serve them better.

In order to get the maximum out of your superior Air Conditioner, we urge you to go through this detailed user manual, if you need any assistance at any time, do not hesitate to call us on 1800 209 5511 or write to us at smartcare@godrej.com

We again thank you for giving us the privilege to serve you, and look forward to a long and delightful association.

Warm Regards,
Team Godrej

PERFORMANCE PARAMETERS

MODEL NAME	GIC 18WTC3-WSB	GIC 18YTC3-WTA	GIC 12WTC3-WTA	GIC 12YTC3-WTA	GIC 12WTC5-WTA	GIC 12YTC5-WTA
OPERATING MODE	Cooling	Cooling	Cooling	Cooling	Cooling	Cooling
RATED VOLTAGE	230 V	230 V	230 V	230 V	230 V	230 V
RATED FREQUENCY/ PHASE	50 Hz/1Ø	50 Hz/1Ø	50 Hz/1Ø	50 Hz/1Ø	50 Hz/1Ø	50 Hz/1Ø
COOLING CAPACITY	5150 W	5150 W	3550 W	3550 W	3500 W	3500 W
RATED POWER INPUT	1840 W	1840 W	1290 W	1290 W	930 W	930 W
RATED INPUT CURRENT	8.40 A	8.40 A	5.90 A	5.90 A	4.50 A	4.50 A
REFRIGERANT	R32	R32	R32	R32	R32	R32
REFRIGERANT CHARGE	0.64 kg	0.64 kg	0.45 kg	0.45 kg	0.63 kg	0.63 kg
AIR FLOW VOLUME	800 CMH	800 CMH	450 CMH	450 CMH	760 CMH	760 CMH
COMP LRA	25.0 A	25.0 A	20.0 A	20.0 A	20.0 A	20.0 A
WEIGHT	IDU	10.00 kg	8.00 kg	8.00 kg	10.00 kg	10.00 kg
	ODU	27.00 kg	27.00 kg	22.60 kg	22.60 kg	24.50 kg

CONTENTS

INTRODUCTION TO REFRIGERANTS R32/R290	1
SAFETY PRECAUTIONS	2
NAMES OF PARTS	5
INDOOR UNIT DISPLAY	6
EMERGENCY FUNCTION & AUTO-RESTART FUNCTION	7
REMOTE CONTROLLER	8
OPERATING INSTRUCTIONS	12
PROTECTION	17
INSTALLATION MANUAL.....	18
MAINTENANCE	31
METHODOLOGY FOR FREQUENCY SETTING	32
TROUBLESHOOTING	33

Protection of Environment:

Protection of environment" is one of the core values of Godrej and we seek your co-operation to make sure that the product, packaging and plastic material is not disposed as unsorted municipal waste.



This symbol is known as the "Crossed-out Wheellie Bin Symbol". It means that the product should not be disposed of with your general house-hold waste.

It should be disposed of only through the company's collection points with special treatment so as to prevent any damage to the environment. Please call: **1800 209 5511** for applicable buy back arrangement or **visit: www.godrejappliances.com/green-think** for details about Godrej Appliances authorised collection points.

In line with the company's policy of continual product improvement, the aesthetic and dimensional characteristics, technical data and accessories of this appliance may be changed without notice.

In line with the company's policy of continual product improvement, the aesthetic and dimensional characteristics, technical data and accessories of this appliance may be changed without notice.

INTRODUCTION TO REFRIGERANTS R32&R290

Introduction to Refrigerants R32 & R290

The refrigerants used for air conditioners are environmentally friendly hydrocarbons R32 and R290. The two kinds of refrigerants are combustible and odorless. Moreover, they can burn and explode under certain condition. However, there will be no risk of burning and explosion if you comply with the following table to install your air conditioner in a room with an appropriate area and use it correctly.

Compared with ordinary refrigerants, Refrigerants R32 & R290 are environmentally friendly and do not destroy the ozone sphere and that their values of greenhouse effect are also very low.

Room area requests for air conditioner with Refrigerants R32 & R290

Refrigerants	Capacity (Btu)	Room Area
R32	9K	Above 4m ²
	12K	Above 4 m ²
	18K	Above 15 m ²
	22K/24K	Above 25 m ²
R290	9K	Above 10 m ²
	12K	Above 13 m ²
	18K	Above 15 m ²
	22K/24K	Above 30 m ²

Warnings

- Please read the manual before installation, using, maintenance.
- Do not use means to accelerate the defrosting process or to clean, other than those recommended by the manufacturer.
- Do not pierce or burn the appliance.
- The appliance shall be stored in a room without continuously operating sources (for example: open flames, an operating ignition gas appliance or an operating electric heater.)
- Please contact the nearest after-sale service center when maintenance is necessary. At the time of maintenance, the maintenance personnel must strictly comply with the Operation Manual provided by the corresponding manufacturer and any non-professional is prohibited to maintain the air conditioner.
- It is necessary to comply with the provisions of gas-related national laws and regulations.
- It is necessary to clear away the refrigerant in the system when maintaining or scrapping an air conditioner.



Warning: Combustible
& Dangerous



Read the user manual





















Read the installation
manual





















Read the service
manual

SAFETY RULES AND RECOMMENDATIONS FOR THE INSTALLER

-  Read this guide before installing and using the appliance.
-  During the installation of the indoor and outdoor units the access to the working area should be forbidden to children. Unforeseeable accidents could happen.
-  Make sure that the base of the outdoor unit is firmly fixed.
-  Check that air cannot enter the refrigerant system and check for refrigerant leaks when moving the air conditioner.
-  Carry out a test cycle after installing the air conditioner and record the operating data.
-  The ratings of the fuse installed in the built-in control unit are T 5A / 250V .
-  The user must protect the indoor unit with a fuse of suitable capacity for the maximum input current or with another overload protection device.
-  Ensure that the mains voltage corresponds to that stamped on the rating plate . Keep the switch or power plug clean. Insert the power plug correctly and firmly into the socket, thereby avoiding the risk of electric shock or fire due to insufficient contact.
-  Check that the socket is suitable for the plug , otherwise have the socket changed.
-  The appliance must be fitted with means for disconnection from the supply mains having a contact separation in all poles that provide full disconnection under overvoltage category III conditions, and these means must be incorporated in the fixed wiring in accordance with the wiring rules.
-  The air conditioner must be installed by professional or qualified persons.

-  Do not install the appliance at a distance of less than 50 cm from inflammable substances (alcohol, etc.) Or from pressurised containers (e.g. spray cans).
-  If the appliance is used in areas without the possibility of ventilation, precautions must be taken to prevent any leaks of refrigerant gas from remaining in the environment and creating a danger of fire
-  The packaging materials are recyclable and should be disposed of in the separate waste bins .Take the air conditioner at the end of its useful life to a special waste collection centre for disposal.
-  Only use the air conditioner as instructed in this booklet . These instructions are not intended to cover every possible condition and situation . As with any electrical household appliance , common sense and caution are therefore always recommended for installation, operation and maintenance.
-  The appliance must be installed in accordance with applicable national regulations.
-  Before accessing the terminals , all the power circuits must be disconnected from the power supply.
-  The appliance shall be installed in accordance with national wiring regulations.
-  This appliance can be used by children aged from 8 years and above and persons with reduced physical, sensory or mental capabilities or lack of experience and knowledge if they have been given supervision or instruction concerning use of the appliance in a safe way and understand the hazards involved. Children shall not play with the appliance. Cleaning and user maintenance shall not be made by children without supervision.

SAFETY RULES AND RECOMMENDATIONS FOR THE USER

-  Do not try to install the conditioner alone; always contact specialized technical personnel.
-  Cleaning and maintenance must be carried out by specialised technical personnel. In any case disconnect the appliance from the mains electricity supply before carrying out any cleaning or maintenance.
-  Ensure that the mains voltage corresponds to that stamped on the rating plate. Keep the switch or power plug clean. Insert the power plug correctly and firmly into the socket, thereby avoiding the risk of electric shock or fire due to insufficient contact.
-  Do not pull out the plug to switch off the appliance when it is in operation, since this could create a spark and cause a fire, etc.
-  This appliance has been made for air conditioning domestic environments and must not be used for any other purpose, such as for drying clothes, cooling food, etc.
-  The packaging materials are recyclable and should be disposed of in the separate waste bins. Take the air conditioner at the end of its useful life to a special waste collection centre for disposal.
-  Always use the appliance with the air filter mounted. The use of the conditioner without air filter could cause an excessive accumulation of dust or waste on the inner parts of the device with possible subsequent failures.
-  The user is responsible for having the appliance installed by a qualified technician, who must check that it is earthed in accordance with current legislation and insert a thermomagnetic circuit breaker.
-  The batteries in remote controller must be recycled or disposed of properly. Disposal of Scrap Batteries --- Please discard the batteries as sorted municipal waste at the accessible collection point.
-  Never remain directly exposed to the flow of cold air for a long time. The direct and prolonged exposition to cold air could be dangerous for your health. Particular care should be taken in the rooms where there are children, old or sick people.
-  If the appliance gives off smoke or there is a smell of burning, immediately cut off the power supply and contact the Service Centre.
-  The prolonged use of the device in such conditions could cause fire or electrocution.
-  Have repairs carried out only by an authorised Service Centre of the manufacturer. Incorrect repair could expose the user to the risk of electric shock, etc.
-  Unhook the automatic switch if you foresee not to use the device for a long time. The airflow direction must be properly adjusted.
-  The flaps must be directed downwards in the heating mode and upwards in the cooling mode.
-  Only use the air conditioner as instructed in this booklet. These instructions are not intended to cover every possible condition and situation. As with any electrical household appliance, common sense and caution are therefore always recommended for installation, operation and maintenance.
-  Ensure that the appliance is disconnected from the power supply when it will remain inoperative for a long period and before carrying out any cleaning or maintenance.
-  Selecting the most suitable temperature can prevent damage to the appliance.

SAFETY RULES AND PROHIBITIONS

- ⊖ Do not bend , tug or compress the power cord since this could damage it. Electrical shocks or fire are probably due to a damaged power cord. Specialised technical personnel only must replace a damaged power cord.
- ⊖ Do not use extensions or gang modules.
- ⊖ Do not touch the appliance when barefoot or parts of the body are wet or damp.
- ⊖ Do not obstruct the air inlet or outlet of the indoor or the outdoor unit.
The obstruction of these openings causes a reduction in the operative efficiency of the conditioner with possible consequent failures or damages.
- ⊖ In no way alter the characteristics of the appliance.
- ⊖ Do not install the appliance in environments where the air could contain gas , oil or sulphur or near sources of heat.
- ⊖ This appliance is not intended for use by persons (including children) with reduced physical, sensory or mental capabilities, or lack of experience and knowledge, unless they have been given supervision or instruction concerning use of the appliance by a person responsible for their safety.
- ⊖ Do not climb onto or place any heavy or hot objects on top of the appliance.
- ⊖ Do not leave windows or doors open for long when the air conditioner is operating.
- ⊖ Do not direct the airflow onto plants or animals.
- ⊖ A long direct exposition to the flow of cold air of the conditioner could have negative effects on plants and animals.
- ⊖ Do not put the conditioner in contact with water.
The electrical insulation could be damaged and thus causing electrocution.
- ⊖ Do not climb onto or place any objects on the outdoor unit
- ⊖ Never insert a stick or similar object into the appliance. It could cause injury.
- ⊖ Children should be supervised to ensure that they do not play with the appliance. If the supply cord is damaged, it must be replaced by the manufacturer, its service agent or similarly qualified persons in order to avoid a hazard.

NAMES OF PARTS

INDOOR UNIT

No.	Description
1	Front panel
2	Air filter
3	Optional filter (if installed)
4	LED Display
5	Signal receiver
6	Terminal block cover
7	Ionizer generator (if installed)
8	Deflectors
9	Emergency button
10	Indoor unit rating label (Stick position optional)
11	Airflow direction louver
12	Remote controller

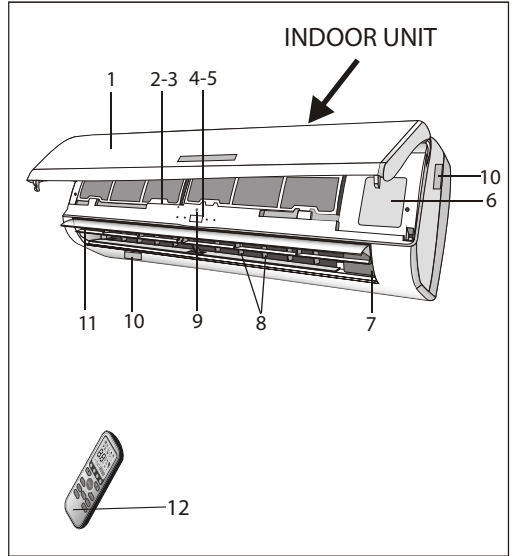

OUTDOOR UNIT

No.	Description
13	Air outlet grill
14	Outdoor unit rating label
15	Terminal block cover
16	Gas valve
17	Liquid valve

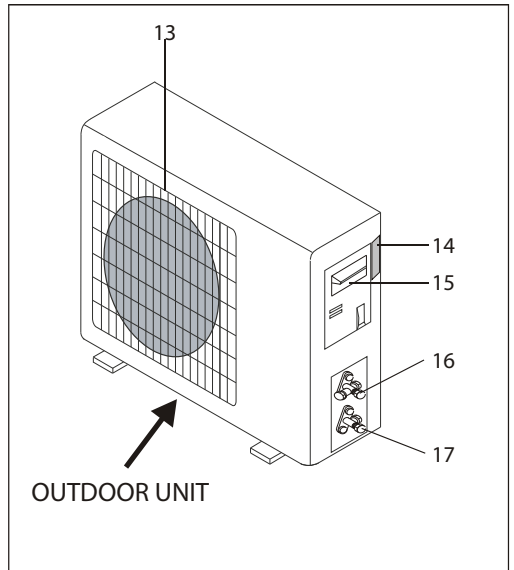

Note: the above figures are only intended to be a simple diagram of the appliance and may not correspond to the appearance of the units that have been purchased.

INDOOR UNIT DISPLAY

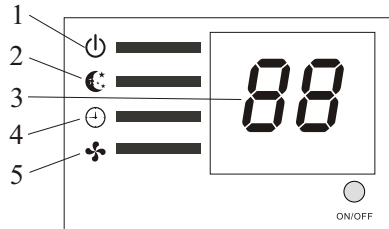
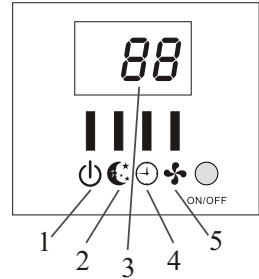
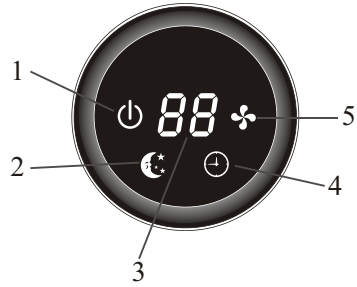
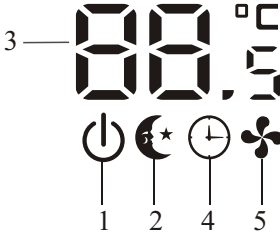
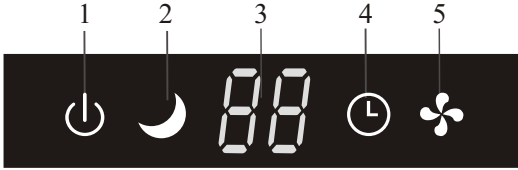
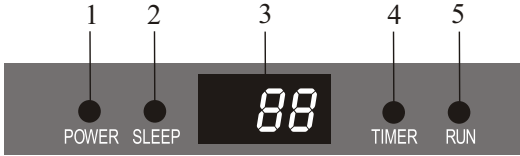

No.	Led		Function
1	POWER	⏻	This symbol appears when the unit is power on
2	SLEEP	🌙	SLEEP mode
3	Temperature display (if present) /Error code	88	(1) Lights up during Timer operation when the air conditioner is operational (2) Displays the malfunction code when fault occurs.
4	TIMER	🕒	Lights up during Timer operation.
5	RUN	🌀	The symbol appears when the unit is turned on, and disappear when the unit is turned off.

⚠️ The shape and position of switches and indicators may be different according to the model, but their function is the same.

EMERGENCY FUNCTION & AUTO-RESTART FUNCTION

AUTO-RESTART FUNCTION

The appliance is preset auto - restart function by manufacturer. In case of a sudden power failure, the module memorizes the setting conditions before the power failure. When the power restores, the unit restarts automatically with all the previous settings preserved by the memory function.

To deactivate the AUTO-RESTART function ,proceed as follows:

1. Switch the air conditioner off and remove the plug.
 2. Press the emergency button meanwhile plug it in.
 3. Keep pressing the emergency button for more than 10 seconds until you hear four short beeps from the unit. The AUTO-RESTART function is deactivate.
- To activate the AUTO - RESTART function , follow the same procedure until you hear three short beeps from the unit.

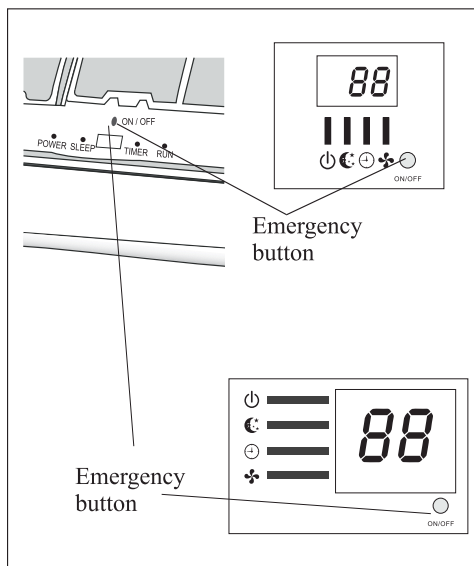

EMERGENCY FUNCTION

If the remote controller fails to work or maintenance necessary, proceed as follows:

Open and lift the front panel up to an angle to reach the emergency button.

1. One press of the emergency button(one beep) will lead to the forced COOLING operation
2. Two press of the emergency button within 3 sec (two beeps) will lead to the forced HEATING operation.
3. To switch off the unit , you just need to press the button again (a single long beep) .
4. After 30 minutes in forced operation , the air conditioner will automatically start working in 23°C cooling mode, auto fan speed.

* The FEEL function is described in page 16 .

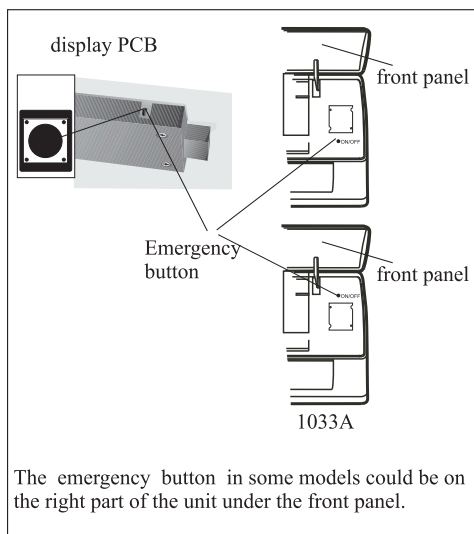

The emergency button in some models could be on the right part of the unit under the front panel.

 *The shape and position of the emergency button may be different according to the model, but their function is the same.*

Remark: the external static pressure of heat pumps is 0 Pa for all models.

REMOTE CONTROLLER

No.	Button	Function
1	▲ (TEMP UP)	Press it to increase temperature / time setting.
2	▼ (TEMP DN)	Press it to decrease temperature/ time setting.
3	ON/OFF	Press it to start or stop operation.
4	FAN	To select the fan speed of auto/low/mid/high
5	TIMER	Press it to set auto-off timer.
6	SLEEP	To activate the function "SLEEP"
7	ECO	In cooling mode, press this button, the temperature will increase 2°C on the base of setting temperature In heating mode, press this button, the temperature will decrease 2°C on the base of setting temperature
8	MODE	To select the mode of operation
9	SUPER or TURBO	Press this button to activate / deactivate the Super function which enables the unit to reach the preset temperature in the shortest time. In COOL mode, the unit will give the maximum cooling temperature with 16°C, high fan speed. In HEAT mode, the unit will give the maximum heating temperature with 31°C, high fan speed.
10	SWING	To activate or deactivate of the movement of the deflectors.
11	CLOCK	When you press this button, the time will be flickering; then through "▲" and "▼", you can adjust the time (one time you press, one minute you adjust; and if you continue to press, the time change rapidly), after adjusting to your required time, please press this button again to fix the time.
12	DISPLAY	To switch on/off the LED display
13	HEALTHY	To switch - on /off HEALTHY function. It is a button which controls the ionizer or plasma generator for available model only.
14	3D	When you press "3D", the horizontal and vertical vanes will swing together at the same time.
15	RESET	To restart REMOTE CONTROLLER
16	ANTI-MILDEW or Mute	To activate the function ANTI-MILDEW or To activate the function of Mute

⚠ The out looking and some function of remote controller maybe difference.

⚠ The shape and position of buttons and indicators maybe difference according to the model, but their function is the same.

⚠ The unit confirms the correct reception of each press button with a beep.

REMOTE CONTROLLER

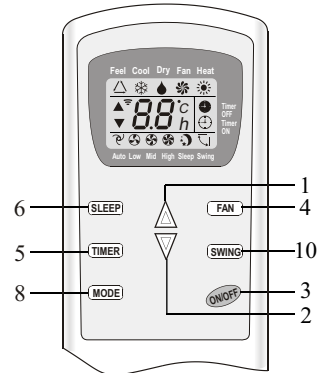
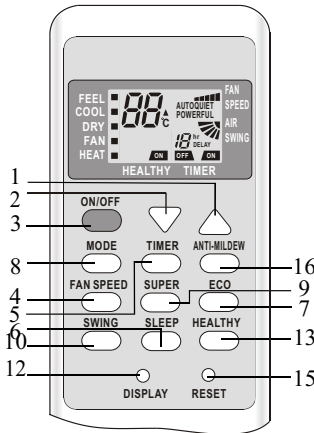
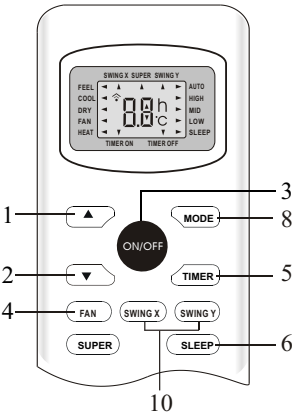
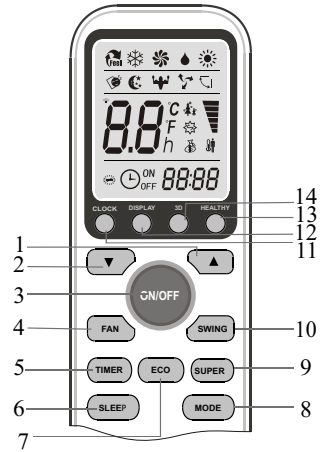
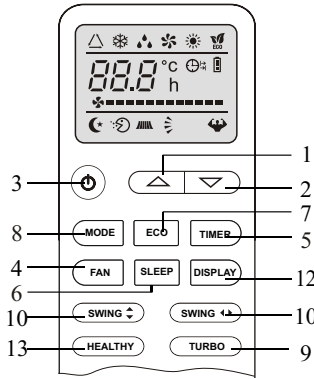
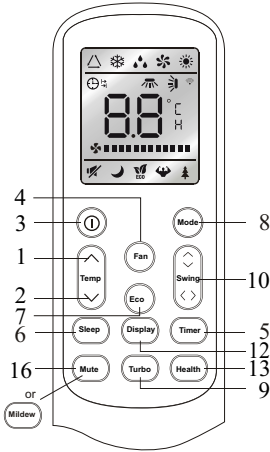



























































⚠ The out looking and some function of remote controller maybe difference.

⚠ The shape and position of buttons and indicators maybe difference according to the model, but their function is the same.

REMOTE CONTROLLER

Remote controller DISPLAY

Meaning of symbols on the liquid crystal display

No.	Symbols	Meaning
1	 or 	FEEL mode indicator
2		COOLING indicator
3	 or 	DEHUMIDIFYING indicator
4		FAN ONLY OPERATION indicator
5		HEATING indicator
6	 or 	SIGNAL RECEPTION indicator
7	 or  or  or 	TIMER OFF indicator
8	 or  or  or 	TIMER ON indicator
9	 or  or  or 	AUTO FAN indicator
10	 or  or  or 	LOW FAN SPEED indicator
11	 or  or  or 	MIDDLE FAN SPEED indicator
12	 or  or  or 	HIGH FAN SPEED indicator
13	 or  or  or 	SLEEP indicator
14		COMFORTABLE SLEEP indicator (optional)
15		FEEL indicator(optional)
16	 or  or  or 	FLAP SWING indicator
17		FLAP and Deflectors SWING indicator
18	 or  or 	SUPER indicator
19	 or  or 	HEALTHY indicator
20	 or  or 	ECO indicator
21		ANTI-MILDEW indicator
22	 or 	BATTERY indicator
23		CLOCK indicator
24		Mute indicator

REMOTE CONTROLLER

Replacement of Batteries

Remove the battery cover plate from the rear of the remote controller, by sliding it in the direction of the arrow.

Install the batteries according the direction (+and -)shown on the Remote Controller.

Reinstall the battery cover by sliding it into place.

⚠ Use 2 LRO 3 AAA (1.5V) batteries . Do not use rechargeable batteries . Replace the old batteries with new ones of the same type when the display is no longer legible.

Do not dispose batteries as unsorted municipal waste. Collection of such waste separately for special treatment is necessary.

⚠ Refer to picture 1:

i. When you open the battery cover, you can see a DIP switch on the cover back.l

DIP switch on position	Function
°C	The remote controller is adjusted in degree celsius
°F	The remote controller is adjusted in degree fahrenheit.
Cool	The remote controller is adjusted in only cooling mode
Heat	The remote controller is adjusted in cooling and heating mode

ii. NOTE:After adjusting the function, you need to take out the batteries and repeat the procedure described above.

⚠ Refer to picture 2:

When you insert the batteries for the first time in the remote controller or if you change them, you need to program the remote controller of only cooling or cooling and heating.

When you insert the batteries, the symbols ❄ (COOL ■) and ☀ (HEAT ■) start flashing. If you push whatever button when the symbol ❄ (COOL ■) is displayed, the remote controller is adjusted in only cooling mode . If you push whatever button when the symbol ☀ (HEAT ■) is displayed , the remote controller is adjusted in Cooling and heating mode.

⚠ NOTE:if you adjust the remote controller in cooling mode, it will not be possible to activate the heating function in units with heating pump . you need to take out the batteries and repeat the procedure described above.

- ⚠
1. Direct the remote controller toward the Air conditioner.
 2. Check that there are no objects between the remote control and the Signal receptor in the indoor unit.
 3. Never leave the remote controller exposed to the rays of the sun
 4. Keep the remote controller at a distance of at least 1m from the television or other electrical appliances.

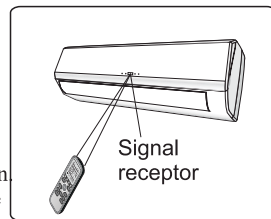
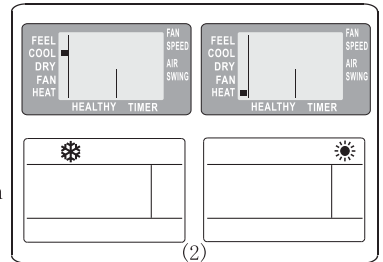
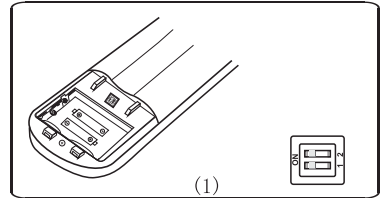
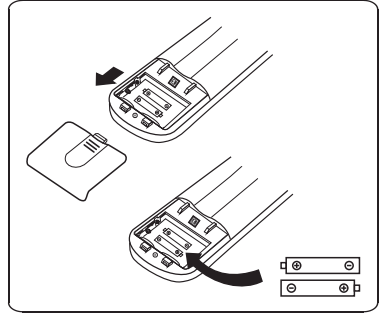

Recommendations for locating and using the remote controller holder (if present)

The remote controller be kept in a wall-mounted holder

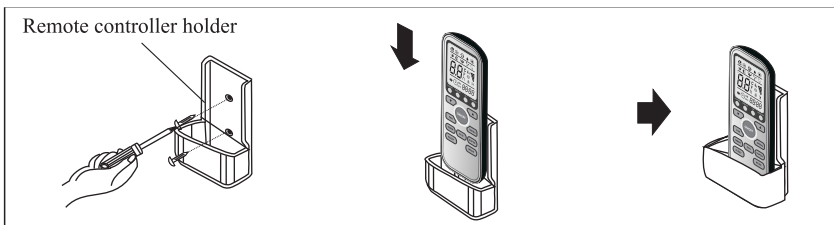

OPERATING INSTRUCTIONS

The air sucked by the fan enters from the grill and passes through the filter, then it is cooled/dehumidified or heated through the heat exchanger.

The direction of the air outlet is motorized up and down by flaps, and manually moved right and left by the vertical deflectors, for some models, the vertical deflectors could be controlled by motor as well.

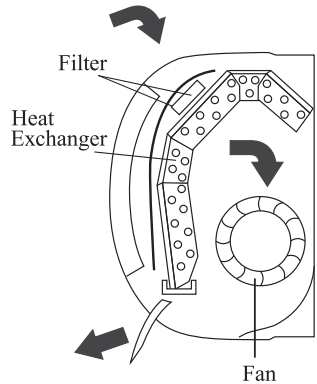

“SWING” CONTROL OF THE AIR FLOW



- The air outlet flow is uniformly distributed in the room.
- It is possible to position the direction of the air in the optimal.

The key **SWING** or **SWING** activates the “FLAP”, the air flow is directed alternatively from up to down. In order to guarantee an even diffusion of the air in the room.

The key **SWING** activates the motorized “deflectors”, the air flow is directed alternatively from left to right. (Optional function, depends on the models)

- In cooling mode, orient the flaps in horizontal direction;
- In heating mode, orient the flaps downward as the warm air tends to rise.

The deflectors are positioned manually and placed under the flaps. They allow to direct the air flow rightward or leftward.

⚠ This adjustment must be done while the appliance is switched off.

⚠ Never position “Flaps” manually, the delicate mechanism might seriously damaged!

⚠ Never poke fingers, sticks or other objects in the air inlet or outlet vents. Such accidental contact with live parts might cause unforeseeable damage or hurt.

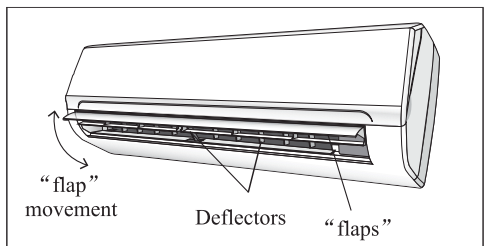
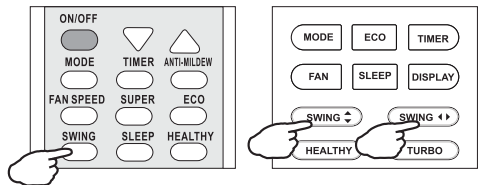
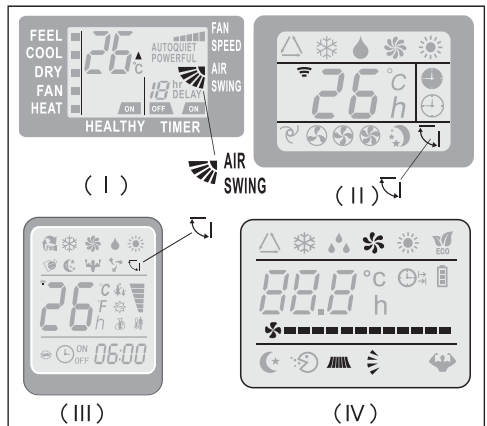

OPERATING INSTRUCTIONS

COOLING MODE

COOL ■ The cooling function allows the air conditioner to cool the room and at the same time reduces Air humidity.

To activate the cooling function (COOL), press the **MODE** button until the symbol ❄️ (COOL ■) appears on the display.

The cooling function is activated by setting the button ▲ or ▼ at a temperature lower than that of the room.

To optimize the function of the Air conditioner, adjust the temperature (1), the speed (2) and the direction of the air flow (3) by pressing the button indicated.

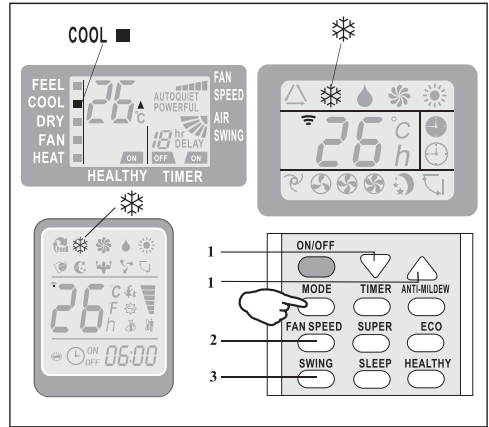

HEATING MODE (Applicable for hot & cold model only)

HEAT ■ The heating function allows the air conditioner to heat the room.

To activate the heating function (HEAT), press the **MODE** button until the symbol ☀️ (HEAT ■) appears on the display.

With the button ▲ or ▼ set a temperature higher than that of the room..

To optimize the function of the Air conditioner adjust the temperature (1), the speed (2) and the direction of the air flow (3) by pressing the button indicated

⚠️ If the appliance is fitted with a electrical heater, which delays appliance to startup in a few seconds to ensure an immediate output of hot air (Optional , depends on the model).

⚠️ In HEATING operation, the appliance can automatically activate a defrost cycle, which is essential to clean the frost on the condenser so as to recover its heat exchange function. This procedure usually lasts for 2-10 minutes during defrosting, indoor unit fan stop operation. After defrosting ,it resumes to HEATING mode automatically.

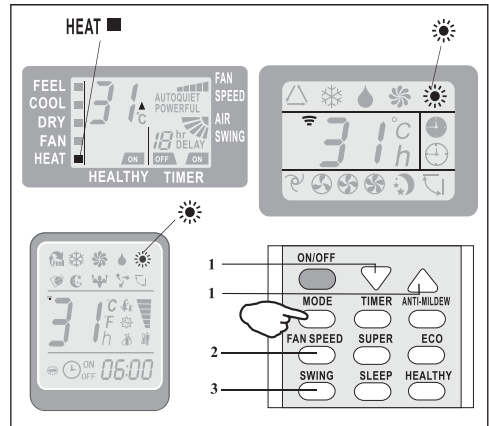

OPERATING INSTRUCTIONS

TIMER MODE----TIMER ON

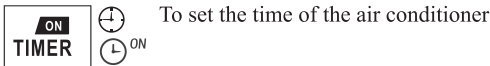

To set the time of the air conditioner

To program the automatical switching-on time, the appliance should be power off.

Press **TIMER** at the first time , set the temperature with pressing the button **▲** or **▼**;

Press **TIMER** at the second time , set the rest time with pressing the button **▲** or **▼**;

Press **TIMER** at the third time, confirm the setting, then the rest time to next automatical switching-on could be read on the display.

NOTE !

Before proceeding with the time: program the working mode with the button **MODE** (2) and the fan speed with the button **FAN** (3) . Switch the conditioner off (with the key **ON/OFF**) .

Note:To cancel the setted function ,press the **TIMER** button again.

Note:In case of power off,it is necessary to set TIMER ON again

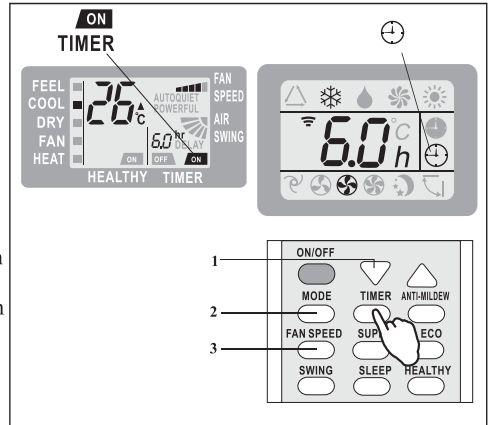

Indoor display

TIMER MODE----TIMER OFF

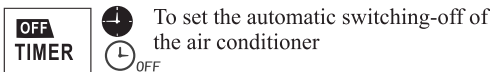

To set the automatic switching-off of the air conditioner

The timed stop is programmed by pressing **TIMER** , Set the rest time by pressing the button **▲** or **▼**,until the rest time displayed is to your demand then press **TIMER** again.

Note:To cancel the setted function, press the **TIMER** button again.

Note:In case of power off,it is necessary to set TIMER OFF again

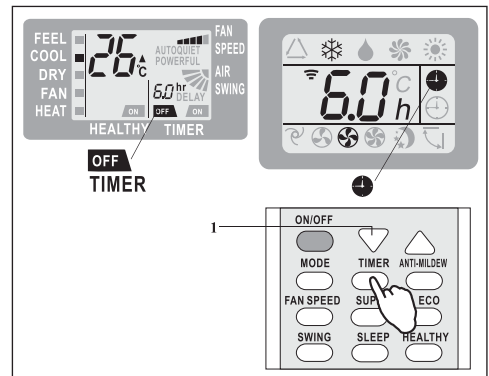

Indoor display

⚠ Note: The TIMER function can be set at half-hour intervals.

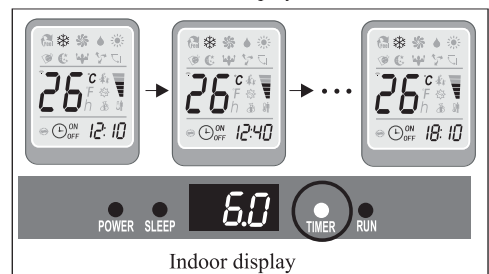

Indoor display

OPERATING INSTRUCTIONS

FAN MODE

FAN ■ 

The conditioner works in only ventilation.

To set the FAN mode, Press **[MODE]** until  (FAN ■) appears in the display.

With pressing **[FAN]** button the speed changes in the following sequence: LOW/ MEDIUM/HIGH /AUTO in FAN mode.

The remote control also stores the speed that was set in the previous mode of operation.

In FEEL mode (automatic) the air conditioner automatically chooses the fan speed and the mode of operation (COOLING or HEATING).

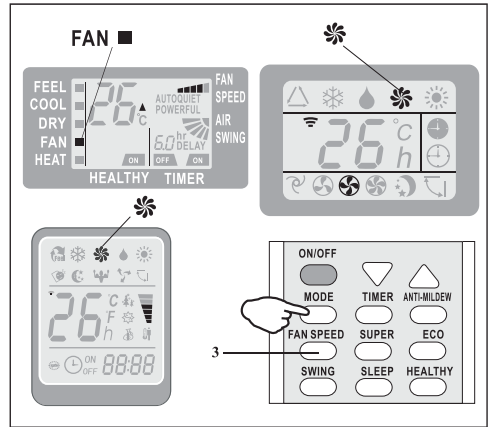

DRY MODE

DRY ■ 

This function reduces the humidity of the air to make the room more comfortable.

To set the DRY mode, Press **[MODE]** until  (DRY ■) appears in the display. An automatic function of alternating cooling cycles and air fan is activated.

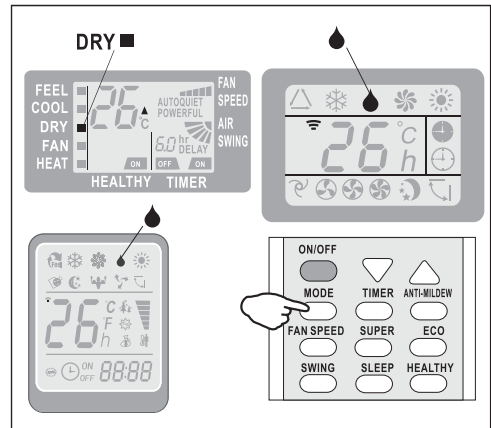

OPERATING INSTRUCTIONS

FEEL MODE



Automatic mode.

To activate the FEEL (automatic) mode of operation, press the **[MODE]** button on the remote controller until the symbol \triangle (FEEL \blacksquare) appears on the display.

In FEEL mode the fan speed and the temperature are set automatically according to the room temperature (tested by the temperature sensor which is incorporated in the indoor unit).

Ambient temp	Operation mode	Auto temp.
< 20°C	HEATING (FOR HEAT PUMP TYPE) FAN (FOR COOL ONLY TYPE)	23°C
20°C~26°C	DRY	18°C
> 26°C	COOL	23°C

To optimize the function of the air conditioner, adjust the temperature (only $\pm 2^\circ\text{C}$) (1), the speed (2) and the direction of the air flow (3) by pressing the buttons indicated

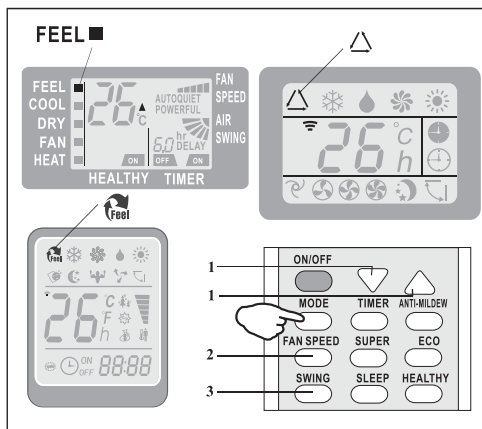

SLEEP MODE



To activate the SLEEP mode of operation, press the **[SLEEP]** button on the remote controller until the symbol ☾ (AUTOQUIET) appears on the display.

The function “SLEEP” automatically adjusts the temperature to make the room more comfortable during the night. In cooling or dry mode, the set temperature will automatically raise by 1°C every 60 minutes, to achieve a total rise of 2°C during the first 2 hours of operation.

In heating mode the set temperature is gradually decreased by 2°C during the first 2 hours of operation.

After 10 hours running in sleep mode the air conditioner is switched off automatically.

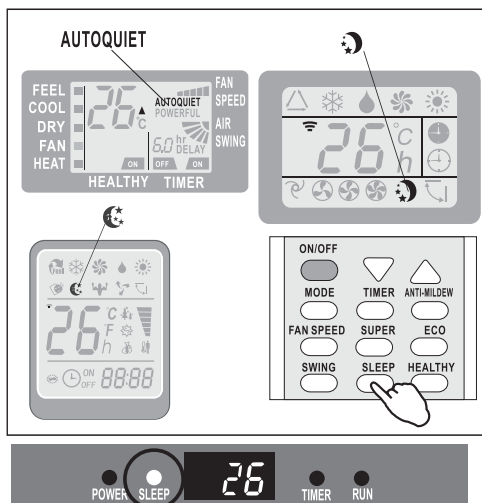

Indoor display

PROTECTION

The air conditioner is programmed for comfortable and suitable living conditions, if it is used in abnormal conditions as below, certain safety protection features might come into effect.

For T1 Climate condition models:

No.	MODE	Ambient temperature
1	Cooling	Outdoor temperature is over 43°C
		Room temperature is below 21 °C
2	Dry	Room temperature is below 18° C

For Tropical (T3) Climate condition models:

No.	MODE	Ambient temperature
1	Heating	Outdoor temperature is over 24°C
		Outdoor temperature is below -7°C
		Room temperature is over 27°C
2	Cooling	Outdoor temperature is over 52°C
		Room temperature is below 21 °C
3	Dry	Room temperature is below 18° C

 *The unit does not operate immediately if it is turned on after being turned off or after changing the mode during operation. this is a normal self-protection action, you need wait for about 3 minutes.*

If a user has set the AC temperature between 16°C and 23°C using the remote, prior to switching the AC OFF; then when the AC is turned ON, it will start operating at 24°C. Also, the remote here will display 24°C.

But, if a user has set the AC temperature above 24°C using the remote, prior to switching the AC OFF; then when the AC is turned ON, it will start operating at the set temperature.

■ Important Considerations

- The air conditioner you buy must be installed by professional personnel and the "Installation manual" is used only for the professional installation personnel! The installation specifications should be subject to our after-sale service regulations.
- When filling the combustible refrigerant, any of your rude operations may cause serious injury or injuries to human body or bodies and object or objects.
- A leak test must be done after the installation is completed.
- It is a must to do the safety inspection before maintaining or repairing an air conditioner using combustible refrigerant in order to ensure that the fire risk is reduced to minimum.
- It is necessary to operate the machine under a controlled procedure in order to ensure that any risk arising from the combustible gas or vapor during the operation is reduced to minimum.
- Requirements for the total weight of filled refrigerant and the area of a room to be equipped with an air conditioner (are shown as in the following Tables GG.1 and GG.2)



INSTALLATION MANUAL---Important considerations

■ The maximum charge and the required minimum floor area

$$m_1 = (4 \text{ m}^3) \times \text{LFL}, m_2 = (26 \text{ m}^3) \times \text{LFL}, m_3 = (130 \text{ m}^3) \times \text{LFL}$$

Where *LFL* is the lower flammable limit in kg/ m³, R290 LFL is 0.038 kg/ m³, R32 LFL is 0.306 kg/ m³.

For the appliances with a charge amount $m_1 < M \leq m_2$:

The maximum charge in a room shall be in accordance with the following: $m_{\max} = 2.5 \times (\text{LFL})^{(5/4)} \times h_0 \times (A)^{1/2}$

The required minimum floor area *A*_{min} to install an appliance with refrigerant charge *M* (kg)

shall be in accordance with following: $A_{\min} = (M / (2.5 \times (\text{LFL})^{(5/4)} \times h_0))^2$

Where:

*m*_{max} is the allowable maximum charge in a room, in kg;

M is the refrigerant charge amount in appliance, in kg;

*A*_{min} is the required minimum room area, in m²;

A is the room area, in m²;

LFL is the lower flammable limit, in kg/m³;

*h*₀ is the installation height of the appliance, in meters for calculating *m*_{max} or *A*_{min}, 1.8 m for wall mounted;

Table GG.1 – Maximum charge (kg)

Category	LFL (kg/m ³)	h ₀ (m)	Floor area (m ²)						
			4	7	10	15	20	30	50
R290	0.038	0.6	0.05	0.07	0.08	0.1	0.11	0.14	0.18
		1	0.08	0.11	0.13	0.16	0.19	0.2	0.3
		1.8	0.15	0.2	0.24	0.29	0.34	0.41	0.53
		2.2	0.18	0.24	0.29	0.36	0.41	0.51	0.65
R32	0.306	0.6	0.68	0.9	1.08	1.32	1.53	1.87	2.41
		1	1.14	1.51	1.8	2.2	2.54	3.12	4.02
		1.8	2.05	2.71	3.24	3.97	4.58	5.61	7.254
		2.2	2.5	3.31	3.96	4.85	5.6	6.86	8.85

Table GG.2 – Minimum room area (m²)

Category	LFL (kg/m ³)	h ₀ (m)	Charge amount (<i>M</i>) (kg)						
			Minimum room area (m ²)						
R290	0.038		0.152kg	0.228 kg	0.304 kg	0.456 kg	0.608 kg	0.76 kg	0.988 kg
		0.6		82	146	328	584	912	1514
		1		30	53	118	210	328	555
		1.8		9	16	36	65	101	171
		2.2		6	11	24	43	68	115
R32	0.306		1.224 kg	1.836 kg	2.448 kg	3.672 kg	4.896 kg	6.12 kg	7.956 kg
		0.6		29	51	116	206	321	543
		1		10	19	42	74	116	196
		1.8		3	6	13	23	36	60
		2.2		2	4	9	15	24	40

■ Installation Safety Principles

1. Site Safety



Open Flames Prohibited



Ventilation Necessary

2. Operation Safety

Open Flames Prohibited



Mind Static Electricity



Must wear protective clothing and anti-static gloves



Don't use mobile phone

3. Installation Safety

- Refrigerant Leak Detector
- Appropriate Installation Location



The left picture is the schematic diagram of a refrigerant leak detector.

Please note that:

1. The installation site should be in a well-ventilated condition.
2. The sites for installing and maintaining an air conditioner using Refrigerant R290 should be free from open fire or welding, smoking, drying oven or any other heat source higher than 370°C which easily produces open fire; the sites for installing and maintaining an air conditioner using Refrigerant R32 should be free from open fire or welding, smoking, drying oven or any other heat source higher than 548°C which easily produces open fire.
3. When installing an air conditioner, it is necessary to take appropriate anti-static measures such as wear anti-static clothing and/or gloves.
4. It is necessary to choose the site convenient for installation or maintenance wherein the air inlets and outlets of the indoor and outdoor units should be not surrounded by obstacles or close to any heat source or combustible and/or explosive environment.
5. If the indoor unit suffers refrigerant leak during the installation, it is necessary to immediately turn off the valve of the outdoor unit and all the personnel should go out till the refrigerant leaks completely for 15 minutes. If the product is damaged, it is a must to carry such damaged product back to the maintenance station and it is prohibited to weld the refrigerant pipe or conduct other operations on the user's site.
6. It is necessary to choose the place where the inlet and outlet air of the indoor unit is even.
7. It is necessary to avoid the places where there are other electrical products, power switch plugs and sockets, kitchen cabinet, bed, sofa and other valuables right under the lines on two sides of the indoor unit.

INSTALLATION MANUAL---Important considerations

■ Special Tools

Tool Name	Requirement(s) for Use
Mini Vacuum Pump	It should be an explosion-proof vacuum pump; can ensure certain precision and its vacuum degree should be lower than 10Pa.
Filling Device	It should be a special explosion-proof filling device; have certain precision and its filling deviation should be less than 5g.
Leak Detector	It should be calibrated regularly; and its annual leak rate should not exceed 10g.
Concentration Detector	A) The maintenance site should be equipped with a fixed-type combustible refrigerant concentration detector and connected to a safeguard alarm system; its error must be not more than 5%. B) The installation site should be equipped with a portable combustible refrigerant concentration detector which can realize two-level audible and visual alarm; its error must be not more than 10%. C) The concentration detectors should be calibrated regularly. D) It is necessary to check and confirm the functions before using the concentration detectors.
Pressure Gauge	A) The pressure gauges should be calibrated regularly. B) The pressure gauge used for Refrigerant 22 can be used for Refrigerants R290 and R161; the pressure gauge used for R410A can be used for Refrigerant 32.
Fire Extinguisher	It is necessary to carry fire extinguisher(s) when installing and maintaining an air conditioner. On the maintenance site, there should be two or more kinds of dry powder, carbon dioxide and foam fire extinguishers and that such fire extinguishers should be placed at stipulated positions, with eye-catching labels and in handy places.

INSTALLATION MANUAL---Selecting the Installation Place

INDOOR UNIT

- Install the indoor unit on a strong wall that is not subject to vibrations.
- The in let and outlet ports should not be obstructed:the air should be able to blow all over the room.
- Do not install the unit near a source of heat , steam,or flammable gas.
- Install the unit near an electric socket or private circuit.
- Do not install the unit where it will be exposed to direct sunlight.
- Select a site where the condensed water can be easily drained out, and where it is easily connected to outdoor unit.
- Check the machine operation regularly and reserve the necessary spaces as shown in the picture.
- Select a place where the filter can be easily taken out.

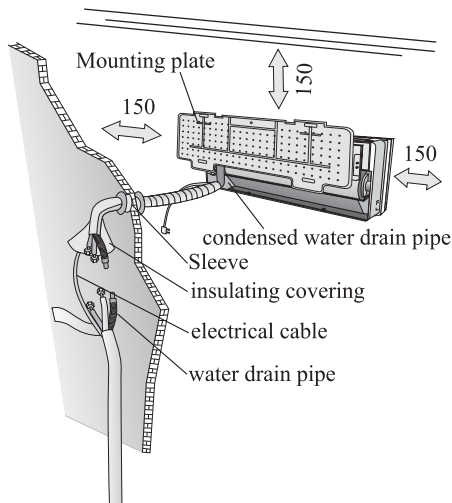

minimum space to be reserved (mm) showing in the picture

OUTDOOR UNIT

- Do not install the outdoor unit near sources of heat, steam or flammable gas.
- Do not install the unit in too windy or dusty places.
- Do not install the unit where people often pass.Select a place where the air discharge and operating sound will not disturb the neighbours.
- Avoid installing the unit where it will be exposed to direct sunlight (other wise use a protection , if necessary, that should not interfere with the air flow).
- Reserve the spaces as shown in the picture for the air to circulate freely.
- Install the outdoor unit in a safe and solid place.
- If the outdoor unit is subject to vibration, place rubber gaskets onto the feet of the unit..

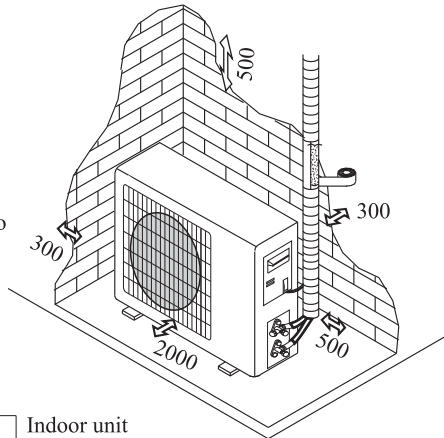

Installation Diagram

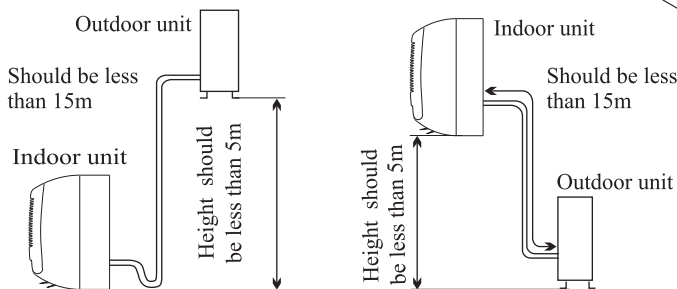

The purchaser must ensure that the person and/or company who is to install, maintain or repair this air conditioner has qualifications and experience in refrigerant products.

INSTALLATION MANUAL---Installation of the Indoor unit

Before starting installation, decide on the position of the indoor and outdoor units, taking into account the minimum space reserved around the units

- ⚠ Do not install your air conditioner in a wet room such as a bathroom or laundry etc
- ⚠ The installation site should be 250cm or more above the floor.

To install, proceed as follows:

Installation of the mounting plate

- 1 Always mount the rear panel horizontally and vertically
2. Drill 32 mm deep holes in the wall to fix the plate;
3. Insert the plastic anchors into the hole;
4. Fix the rear panel on the wall with provided tapping screws
5. Be sure that the rear panel has been fixed firmly enough to withstand the weight

Note : The shape of the mounting plate may be different from the one above, but installation method is similar .

Drilling a hole in the wall for the piping

1. Make the piping hole ($\Phi 55$) in the wall at a slight downward slant to the outdoor side.
2. Insert the piping-hole sleeve into the hole to prevent the connection piping and wiring from being damaged when passing through the hole.

- ⚠ The hole must slope downwards towards the exterior

Note : Keep the drain pipe down towards the direction of the wall hole, otherwise leakage may occur.

Electrical connections---Indoor unit

1. Open the front panel.
2. Take off the cover as indicated in the picture (by removing a screw or breaking the hooks).
3. For the electrical connections, see the circuit diagram on the right part of the unit under the front panel.
4. Connect the cable wires to the screw terminals by following the numbering ,Use wire size suitable to the electric power input (see name plate on the unit) and according to all current national safety code requirements.

- ⚠ The cable connecting the outdoor and indoor units must be suitable for outdoor use.

- ⚠ The plug must be accessible also after the appliance has been installed so that it can be pulled out if necessary.

- ⚠ An efficient earth connection must be ensured.

- ⚠ If the power cable is damaged, it must be replaced by an authorised Service Centre.

Note: Optional the wires can be connected to the main PCB of indoor unit by manufacturer according to the model without terminal block.

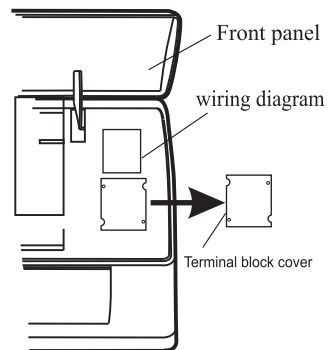
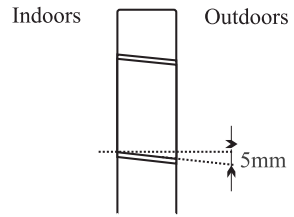
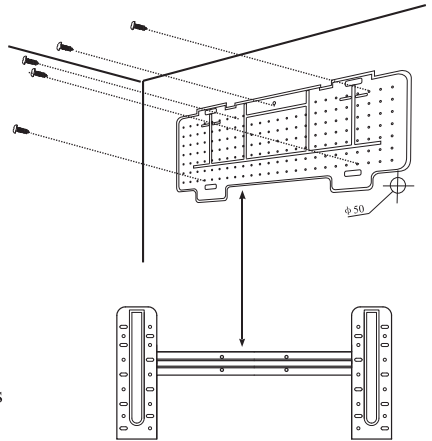

INSTALLATION MANUAL---Installation of the Indoor unit

Refrigerant piping connection

The piping can be run in the 3 directions indicated by numbers in the picture . When the piping is run in direction 1 or 3, cut a notch along the groove on the side of the indoor unit with a cutter.

Run the piping in the direction of the wall hole and bind the copper pipes , the drain pipe and the power cables together with the tape with the drain pipe at the bottom, so that water can flow freely.

- Do not remove the cap from the pipe until connecting it, to avoid dampness or dirt from entering.
- If the pipe is bent or pulled too often , it will become stiff . Do not bend the pipe more than three times at one point.
- When extending the rolled pipe, straighten the pipe by unwinding it gently as shown in the picture.

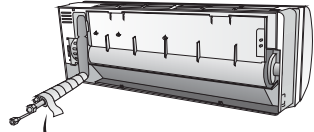
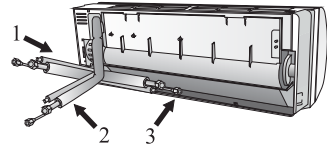

Shape the connection pipe

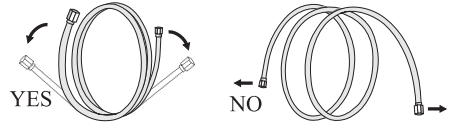

Extending the rolled pipe

Connections to the indoor unit

1. Remove the indoor unit pipe cap (check that there is no debris inside).
2. Insert the flare nut and create a flange at the extreme end of the connection pipe.
3. Tighten the connections by using two wrenches working in opposite directions



torque wrench

Indoor unit condensed water drainage

The indoor unit condensed water drainage is fundamental for the success of the installation.

1. Place the drain hose below the piping, taking care not to create siphons.
2. The drain hose must slant downwards to aid drainage.
3. Do not bend the drain hose or leave it protruding or twisted and do not put the end of it in water . If an extension is connected to the drain hose , ensure that it is lagged when it passes into the indoor unit.
4. If the piping is installed to the right, the pipes, power cable and drain hose must be lagged and secured onto the rear of the unit with a pipe connection.
 - 1) Insert the pipe connection into the relative slot.
 - 2) Press to join the pipe connection to the base.

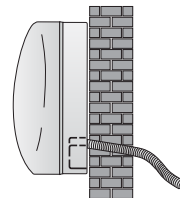

YES

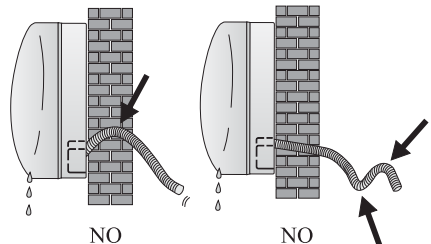

NO

NO

INSTALLATION MANUAL---Installation of the Indoor unit

INSTALLATION OF THE INDOOR UNIT

After having connected the pipe according to the instructions, install the connection cables. Now install the drain pipe. After connection, lag the pipe, cables and drain pipe with the insulating material.

1. Arrange the pipes ,cables and drain hose well.
2. Lag the pipe joints with insulating material , securing it with vinyl tape.
3. Run the bound pipe , Cables and drain pipe through the wall hole and mount the indoor unit onto the upper part of the mounting plate securely.
4. Press and push the lower part of the indoor unit tightly against the mounting plate

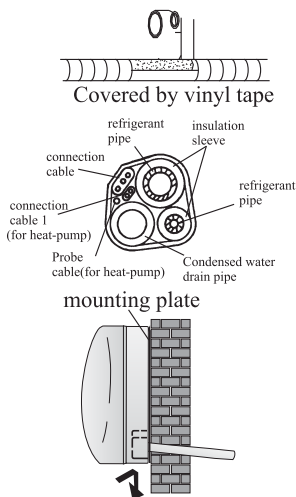

INSTALLATION MANUAL---Installation of the outdoor unit

- The outdoor unit should be installed on a solid wall and fastened securely.
- The following procedure must be observed before connecting the pipes and connecting cables : decide which is the best position on the wall and leave enough space to be able to carry out maintenance easily.
- Fasten the support to the wall using screw anchors which are particularly suited to the type of wall;
- Use a larger quantity of screw anchors than normally required for the weight they have to bear to avoid vibration during operation and remain fastened in the same position for years without the screws becoming loose.
- The unit must be installed following the national regulations.

Outdoor unit condensed water drainage (only for heat pump models)

The condensed water and the ice formed in the outdoor unit during heating operation can be drained away through the drain pipe

1. Fasten the drain port in the 25mm hole placed in the part of the unit as shown in the picture.
 2. Connect the drain port and the drain pipe.
- Pay attention that water is drained in a suitable place.

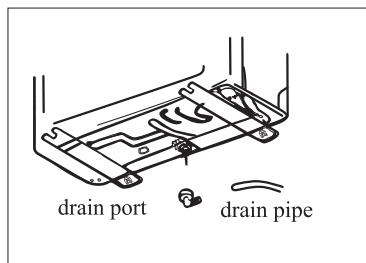

INSTALLATION MANUAL---Installation of the outdoor unit

ELECTRICAL CONNECTIONS

1. Remove the handle on the right side plate of outdoor unit.
2. Connect the power connection cord to the terminal board.
Wiring should fit that of indoor unit.
3. Fix the power connection cord with wire clamp.
4. Confirm if the wire has been fixed properly.
5. An efficient earth connection must be ensured.
6. Recover the handle.

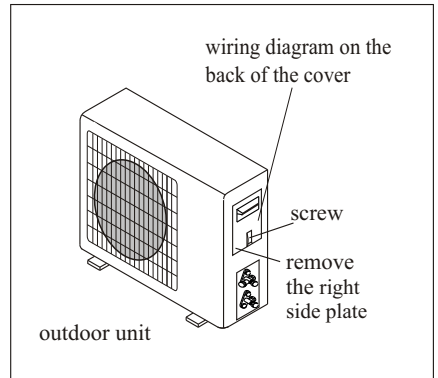

CONNECTING THE PIPES

Screw the flare nuts to the outdoor unit coupling with the same tightening procedures described for the indoor unit.

To avoid leakage, pay attention to the following points:

1. Tighten the flare nuts using two wrenches. Pay attention not to damage the pipes.
2. If the tightening torque is not sufficient, there will probably be some leakage. With excessive tightening torque there will also be some leakage, as the flange could be damaged.
3. The surest system consists in tightening the connection by using a fix wrench and a torque wrench: in this case use the table on page 29.

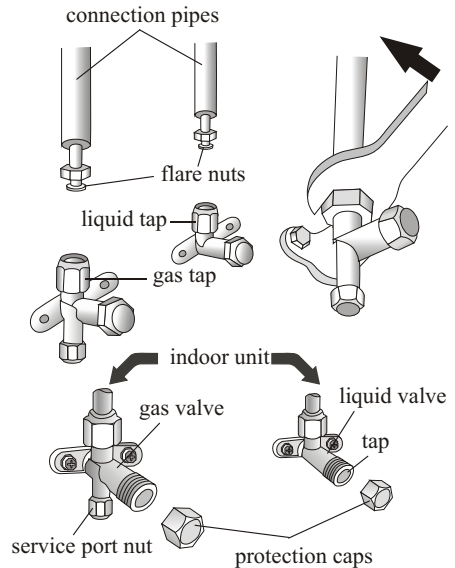

BLEEDING

Air and humidity left inside the refrigerant circuit can cause compressor malfunction. After having connected the indoor and outdoor units, bleed the air and humidity from the refrigerant circuit by using a vacuum pump.

Refrigerant Pressure Inspection

The low pressure range of refrigerant R290 is 0.4-0.6 Mpa, and the high pressure range is 1.5-2.0Mpa; The low pressure range of refrigerant R32 is 0.8-1.2Mpa, and the high pressure range is 3.2-3.7Mpa; It means that the refrigerating system or refrigerant of an air conditioner is abnormal if the low or high pressure ranges of the detected compressor exceed the normal ranges.

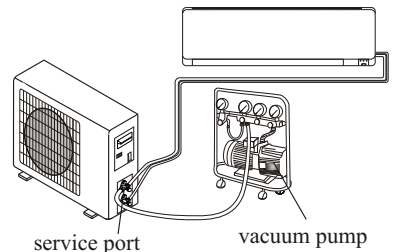

INSTALLATION MANUAL---Installation of the outdoor unit

BLEEDING

The air and humidity left inside the refrigerant circulation can cause compressor malfunction. After having connected the indoor and outdoor units, bleed the air and humidity from the refrigerant circulation using a vacuum pump.

- (1) Unscrew and remove the caps from the 2 - way and 3-way valves.
- (2) Unscrew and remove the cap from the service port.
- (3) Connect the vacuum pump hose to the service port.
- (4) Operate the vacuum pump for 10 - 15 minutes until an absolute vacuum of 10 mm Hg has been reached.
- (5) With the vacuum pump still in operation , close the low - pressure knob on the vacuum pump coupling. Stop the vacuum pump.
- (6) Open the 2 - way valve by 1/4 turn and then close it after 10 seconds. Check all the joints for leaks using liquid soap or an electronic leak device.
- (7) Turn the body of the 2-way and 3-way valves. Disconnect the vacuum pump hose.
- (8) Replace and tighten all the caps on the valves.

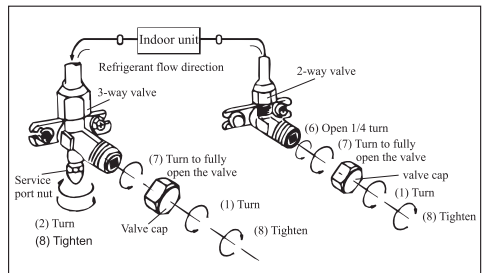
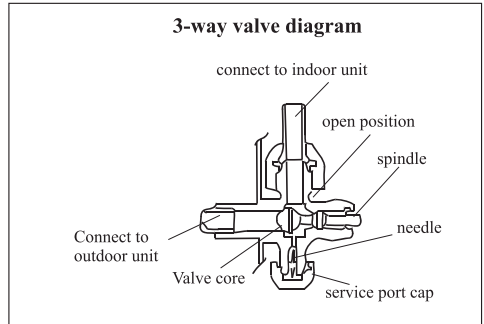

INSTALLATION MANUAL--- operation test

1. Wind insulating covering around the joints of the indoor unit and fix it with insulating tape.
2. Fix the exceeding part of the signal cable to the piping or to the outdoor unit.
3. Fix the piping to the wall (after having coated it with insulating tape) using clamps or insert them into plastic slots.
4. Seal the hole in the wall through which the piping is passed so that no air or water can fill.

Indoor unit test

- Do the ON/OFF and FAN operate normally?
- Does the MODE operate normally?
- Do the set point and TIMER function properly?
- Does each lamp light normally?
- Do the flap for air flow direction operate normally?
- Is the condensed water drained regularly?

Outdoor unit test

- Is there any abnormal noise or vibration during operation?
- Could the noise , the air flow or the condensed water drainage disturb the neighbours?
- Is there any coolant leakage?

Note: the electronic controller allows the compressor to start only three minutes after voltage has reached the system.

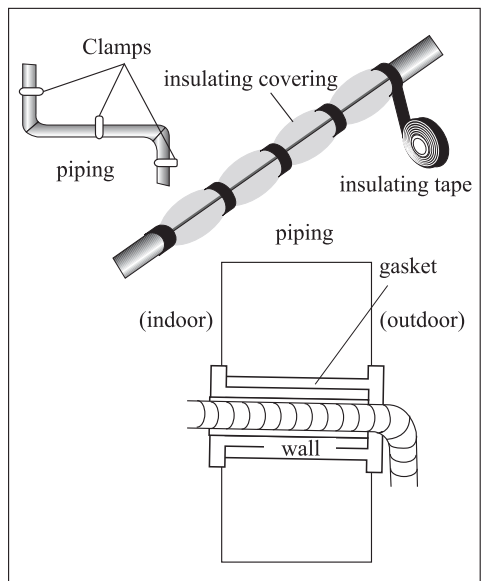

INSTALLATION MANUAL---Information for the installer

MODEL capacity (Btu/h)	9k/12K	18k/24K
Lenght of pipe with standard charge	4m	4m
Maximum distance between indoor and outdoor unit	15m	15m
Additional refrigerant charge	15g/m	25g/m
Max. diff. in level between indoor and outdoor unit	5m	5m
Type of refrigerant(1)	R32/R290	R32/R290

(1) Refer to the data rating label stucked on the outdoor unit.

(2)The total charge amount should under the maximum according to the table GG.1 in page18.

TIGHTENING TORQUE FOR PROTECTION CAPS AND FLANGE CONNECTION

PIPE	TIGHTENING TORQUE [N x m]	CORRESPONDING STRESS (using a 20 cm wrench)		TIGHTENING TORQUE [N x m]
1/4 " (ϕ 6)	15 - 20	wrist strength	Service port nut	7 - 9
3/8 " (ϕ 9.52)	31 - 35	arm strength	Protection caps	25 - 30
1/2 " (ϕ 12)	35 - 45	arm strength		
5/8 " (ϕ 15.88)	75 - 80	arm strength		

INSTALLATION MANUAL---Information for the installer

WIRING DIAGRAM

For different models, the wiring diagram may be different. Please refer to the wiring diagrams pasted on the indoor unit and outdoor unit respectively.

On indoor unit, the wiring diagram is pasted under the front panel;

On outdoor unit, the wiring diagram is pasted on the backside of the outdoor handle cover.

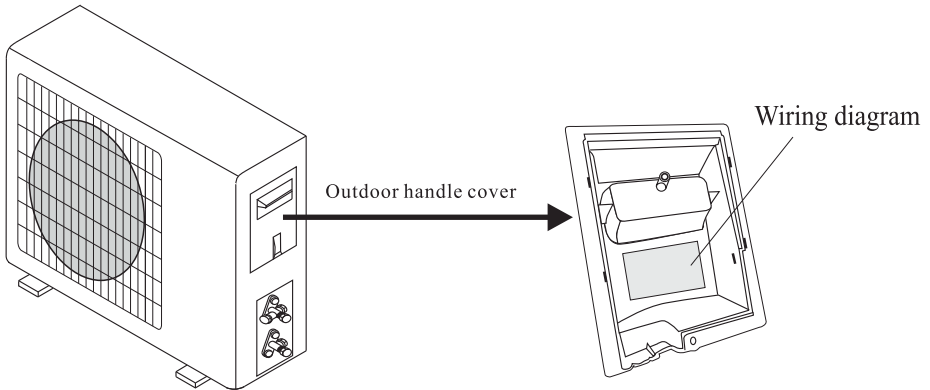
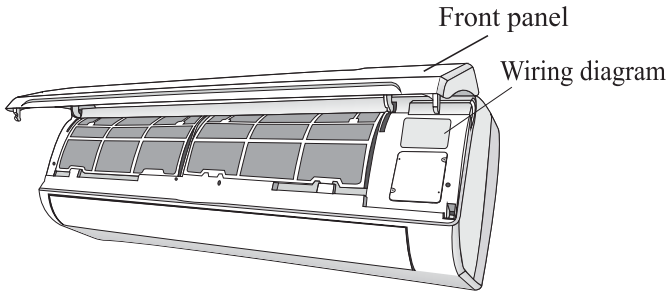

Note: For some models the wires has been connected to the main PCB of indoor unit by manufacturer without terminal block.

INSTALLATION MANUAL---Information for the installer

CABLE WIRES SPECIFICATION

MODEL capacity (Btu/h)		5k	7k	9k	12k	15/18k	22/24k	28/30k/36k
		sectional area						
Power supply cable	N	1.0mm ² AWG18	1.0mm ² AWG18	1.0mm ² AWG18	1.0mm ² (1.5mm ²) AWG18 (AWG16)	1.5mm ² AWG16	2.5mm ² AWG14 H05RN-F	4.0mm ² AWG12
	L	1.0mm ² AWG18	1.0mm ² AWG18	1.0mm ² AWG18	1.0mm ² (1.5mm ²) AWG18 (AWG16)	1.5mm ² AWG16	2.5mm ² AWG14 H05RN-F	4.0mm ² AWG12
	E	1.0mm ² AWG18	1.0mm ² AWG18	1.0mm ² AWG18	1.0mm ² (1.5mm ²) AWG18 (AWG16)	1.5mm ² AWG16	2.5mm ² AWG14 H05RN-F	4.0mm ² AWG12
Connection supply cable	N	1.0mm ²	1.0mm ²	1.0mm ²	1.0mm ² (1.5mm ²)	1.5mm ²	0.75mm ²	0.75mm ²
	L	1.0mm ²	1.0mm ²	1.0mm ²	1.0mm ² (1.5mm ²)	1.5mm ²	0.75mm ²	0.75mm ²
	1	1.0mm ²	1.0mm ²	1.0mm ²	1.0mm ² (1.5mm ²)	1.5mm ²	0.75mm ²	0.75mm ²
	2	0.75mm ²	0.75mm ²	0.75mm ²	0.75mm ²	0.75mm ²	0.75mm ²	0.75mm ²
	3	0.75mm ²	0.75mm ²	0.75mm ²	0.75mm ²	0.75mm ²	0.75mm ²	0.75mm ²
	⊕	0.75mm ²	0.75mm ²	0.75mm ²	0.75mm ²	0.75mm ²	0.75mm ²	0.75mm ²

INVERTER TYPE MODEL capacity (Btu/h)				9k	12k	18/22k	24k	
		sectional area						
Power supply cable	N			1.0mm ² (1.5mm ²) AWG18 (AWG16)	1.0mm ² (1.5mm ²) AWG18 (AWG16)	1.5mm ² AWG16	2.5mm ² AWG14	
	L			1.0mm ² (1.5mm ²) AWG18 (AWG16)	1.0mm ² (1.5mm ²) AWG18 (AWG16)	1.5mm ² AWG16	2.5mm ² AWG14	
	E			1.0mm ² (1.5mm ²) AWG18 (AWG16)	1.0mm ² (1.5mm ²) AWG18 (AWG16)	1.5mm ² AWG16	2.5mm ² AWG14	
Connection supply cable	N			1.0mm ² (1.5mm ²)	1.0mm ² (1.5mm ²)	1.5mm ²	0.75mm ²	
	L			1.0mm ² (1.5mm ²)	1.0mm ² (1.5mm ²)	1.5mm ²	0.75mm ²	
	1			1.0mm ² (1.5mm ²)	1.0mm ² (1.5mm ²)	1.5mm ²	0.75mm ²	
	⊕			1.0mm ² (1.5mm ²)	1.0mm ² (1.5mm ²)	1.5mm ²	0.75mm ²	

220V 7K , 9K , 12K 15K , 16K , 18K , 22K , 24K , 30K air conditioner indoor unit fuse parameter is 50T, 3.15A
 110V 7K , 9K 12k air conditioner indoor unit fuse parameter is 50T, 3.15A,
 125V 7K , 9K , 12K air conditioner outdoor unit fuse parameter is 61T, 15A
 250V 18K , 22K , 24K air conditioner outdoor unit fuse parameter is 65TS, 25A

MAINTENANCE

Periodic maintenance is essential for keeping your air conditioner efficient.

Before carrying out any maintenance, disconnect the power supply by taking the plug out from the socket.

INDOOR UNIT

ANTIDUST FILTERS

1. Open the front panel following the direction of the arrow
2. Keeping the front panel raised with one hand, take out the air filter with the other hand
3. Clean the filter with water; if the filter is soiled with oil, it can be washed with warm water (not exceeding 45°C).
Leave to dry in a cool and dry place.
4. Keeping the front panel raised with one hand, insert the air filter with the other hand
5. Close

The electrostatic and the deodorant filter (if installed) cannot be washed or regenerated and must be replaced with new filters after every 6 months.

CLEANING THE HEAT EXCHANGER

1. Open the front panel of the unit and lift it till its greatest stroke and then unhooking it from the hinges to make the cleaning easier.
2. Clean the indoor unit using a cloth with the water (not higher than 40°C) and neutral soap. Never use aggressive solvents or detergents.
3. If the outdoor unit is clogged, remove the leaves and the waste and remove the dust with air jet or a bit of water.

END OF SEASON MAINTENANCE

1. Disconnect the automatic switch or the plug.
2. Clean and replace the filters
3. On a sunny day let the conditioner work in ventilation for some hours, so that the inside of the unit can dry completely.

REPLACING THE BATTERIES

When:

- There is no confirmation beep heard from the indoor unit.
- The LCD doesn't act.

How:

- Take off the cover at back.
- Place the new batteries respecting the symbols + and -.

N.B: Use only new batteries. Remove the batteries from the remote controller when the conditioner is not in operation

WARNING! Do not throw batteries into common rubbish, they should be disposed of in the special containers situated in the collection points.

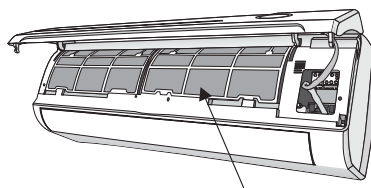
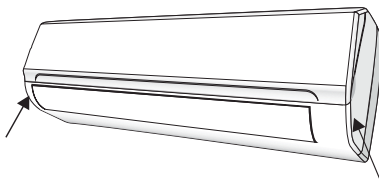

antidust filter

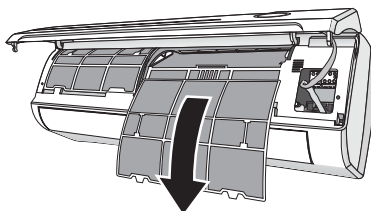

METHODOLOGY FOR FREQUENCY SETTING

Full load and half load capacity modes are applicable only for testing purpose in authorized test laboratories.

Before setting the mode, lab conditions to be stabilized as per IS1391 Part 2.

Test Mode Activate:

Running the AC, in cooling modeset temperature at 30 degree,middle fan speed.
Press 7 times sleep button with 8 seconds,
After 3 times Beep sound & test mode will activate.

Then Remote set temperature: 25°C to test full capacity.

After finish full capacity test, no stop the AC, directly make Remote set temperature: 26°C to test half capacity.

TROUBLESHOOTING

MALFUNCTION	POSSIBLE CAUSES
The appliance does not operate	Power failure/plug pulled out
	Damaged indoor/outdoor unit fan motor
	Faulty compressor thermomagnetic circuit breaker
	Faulty protective device or fuses.
	Loose connections or plug pulled out
	It sometimes stops operating to protect the appliance.
	Voltage higher or lower than the voltage range
	Active TIMER-ON function
Strange odour	Damaged electronic control board
Strange odour	Air filter dirty
Noise of running water	Back flow of liquid in the refrigerant circulation
A fine mist comes from the air outlet	This occurs when the air in the room becomes very cold, for example in the “COOLING” or “DEHUMIDIFYING/DRY” modes.
A strange noise can be heard	This noise is made by the expansion or contraction of the front panel due to variations in temperature and does not indicate a problem.
Insufficient airflow, either hot or cold	Inappropriate temperature setting..
	Air inlet or outlet of indoor or outdoor unit has been blocked.
	Air filter is blocked.
	Fan speed set at minimum.
	Other sources of heat in the room.
The appliance does not respond to commands	No refrigerant.
	Remote control is not near enough to indoor unit.
	Battery in Remote controller may have been exhausted..
The display is off	Obstacles between remote control and signal receiver in indoor unit.
	Active LED function
	Power failure

Switch off the air conditioner immediately and cut off the power supply in the event of:

- Strange noises during operation.
- Faulty electronic control board
- Faulty fuses or switches.
- Spraying water or objects inside the appliance.
- Overheated cables or plugs.
- Very strong smells coming from the appliance.

ERROR SIGNALS ON THE DISPLAY

In case of error, the display on the indoor unit shown the following error codes:

	RUN lamp	Description of the trouble
<i>E1</i>	flashes once	The fault of indoor temperature sensor
<i>E2</i>	flashes twice	The fault of indoor pipe temperature sensor
<i>E5</i>	flashes 6 times	Malfunction of indoor fan motor.

ERROR SIGNALS ON DISPLAY

In case of error, the display on the indoor unit show the following error codes.

Digital LED Code	Failure Type
E0	Indoor and outdoor communication failure
EC	Outdoor communication failure
E1	Indoor room temperature sensor (IRT)
E2	Indoor coil temperature sensor (IPT)
E3	Outdoor coil temperature sensor (OPT)
E4	System abnormality
E5	Model configuration wrong
E6	Indoor fan motor fault
E7	Outdoor temperature sensor
E8	Exhaust temp. sensor
E9	IPM drive and module fault
EF	Outdoor fan motor fault (DC motor)
EA	Current sensor fault
EE	Indoor unit EEPROM fault
EP	Temp. switch fault (on top of the compressor)
EU	Voltage sensor fault

BRANCH ADDRESSES / SERVICE CONNECT

GODREJ & BOYCE MFG. CO. LTD., Appliances Division	
Branch	Branch Addresses
Ahmedabad	4th Floor, APM Shopping Mall Near IOCL Petrol Pump, Shyamal-Karnavati, 100 ft. Road, Satellite, Ahmedabad - 380 015
Bangalore	3rd Floor, The Karnataka Film Chamber of Commerce Bldg. 28, 1st Main, Crescent Road, High Grounds Nr. Shivanand Circle, Bangalore - 560 001
Bhopal	217, Zone I, M.P. Nagar, Beh. Jyoti Talkies, Bhopal - 462 011
Bhubaneswar	Highway Complex, NH-5, Rudrapur, Bhubaneswar - 752 101
Chandigarh/Mohali	Plot No. A-40, Phase VIII-A, Industrial Area, Mohali - 160 059
Chennai	No. 1, Sidco Industrial Estate, Ambattur, Chennai - 600 098
Coimbatore	No. 585 - 590 3rd Floor, Sathya Towers, DB Road, R S Puram, Coimbatore - 641002
Delhi	Godrej Bhavan, 2nd Floor, Shershah Suri Marg, Mathura Road, Okhla, New Delhi - 110 065
Faridabad	Godrej Bhavan, 2nd Floor, Shershah Suri Marg, Mathura Road, Okhla, New Delhi - 110 065
Ghaziabad	Plot No. 229/230, Sardar Pashu Ahaar, Bulandshahar Road, Village-chaprola, Ghaziabad
Guwahati	Basundhara Enclave, 1st & 2nd Floor Ulubari, Guwahati 781007
Hyderabad	201 & 202, Lala-1 Land Mark, 5-4-94 to 97, 2nd Floor, Above Digital Shoppy, Ranigunj, M.G. Road, Secunderabad -500 003
Jaipur	502-506, 5th Floor, Gaurav Towers, Malviya Nagar, Jaipur - 302 017
Kochi	2nd floor, Angels Arcade, South Kalamasserry, Near CUSAT PO Kochi 682022
Kolkata	Plot-30, Block-GN, Sector-V, Salt Lake city, Kolkata - 700 091
Lucknow	C-3/3 & C-3/4, Sanjay Complex, Near All India Radio, Vidhan Sabha Marg, Lucknow-226001
Mumbai	Appliance Division, Plant 4, Pirojshahnagar, Vikhroli, Mumbai - 400 079
Nagpur	Dr. Bhiwapurkar Chamber, 2nd Floor, Opp. Yashwant Stadium, Dhantoli, Nagpur - 440 012
Patna	Grand Plaza 6th Floor, 6001-6004, Dakbunglow Crossing. Frazer Road. Patna-800001
Pune	Apollo Building Square, Plot No. 60, Survey No. 599, Sahaney Sujan Park, Lullanagar, Bibewadi Road, Pune - 411 040
Raipur	9/1, Besides Bharat Petrol Pump, Opp, Hotel Picadelly, Mahoba Bazaar, G.E. Road, Raipur - 492 001, Chhatisgarh
Ranchi	C/o. Surya Motors, Near Krishi Bazaar Samiti Pandra, Ranchi (Jharkand) - 835 222
Toll-Free : 1800-209-5511	
Website: www.godrejappliances.com & www.godrejsmartcare.com	
E-mail: smartcare@godrej.com	

WARRANTY AIR CONDITIONER

The Godrej Air Conditioner comes with a FIVE year warranty on compressor for fixed speed Air conditioners and TEN year warranty on compressor for Inverter Air Conditioners. Along with this, you also get ONE year warranty on all other parts (except grill & plastic parts) from the date of purchase, against defective material or workmanship. In case of any such defect found during the first year from date of purchase, Godrej & Boyce Mfg. Co. Ltd.-Appliance Division will undertake repairs to the warranted part free of charge, subject to terms and conditions below. In the warranty period beyond the first year from date of purchase, only the compressor will be provided free of cost, when necessary. However, the Air Conditioner will be repaired on payment of necessary charges. The warranty does not cover the demonstration/installation of the Air Conditioner.

INSTRUCTIONS FOR THE CUSTOMER

1. Kindly ensure that the dealer fills the warranty card correctly and completely.
2. You should retain the warranty card for record and produce the same in the event of any warranty repairs.
3. In the event of a defect developing in the product, contact the nearest authorized Godrej & Boyce Service Center for obtaining warranty service and inform the defect, Model details & Serial No.
4. Product will function between +/-10% of rated volts at 50Hz. For any fluctuation beyond specified limit, company shall not be responsible and warranty stands terminated.
5. In areas where voltage fluctuates below 10% of rated voltage, customer is advised to use a voltage stabilizer which steps up voltage to a minimum of 190V.
6. Earthing provision is necessary for safety. Improper domestic wiring leading to hazards such as shock or fire is not covered under this warranty.
7. The product must be maintained to ensure hygiene. If there are any insects or rodents in it causing obstruction to the functioning of the product, the company shall not be responsible and in-turn warranty stands terminated.

TERMS AND CONDITIONS

1. Repairs and replacement will be carried out by the companies authorized service centers or through authorized dealer's service center.
2. All transportation and handling expenses incurred while repairing will be payable by the customer in advance.
3. For any Air Conditioner installed beyond the municipal limits of the jurisdiction of the authorized customer service center, charges towards technician's visit will be borne by the customer
4. While the company will make every effort to carry out the repairs at the earliest, it however is made expressly clear that the company is under no obligation to do so in a specified period of time.
5. The company will retain any part(s), compressor and/or other components when replaced at its discretion.
6. Warranty does not cover accessories to the Air Conditioner.
7. Refrigeration system gas charging and consumables will be charged for any such repairs after one year from the date of purchase.
8. Company will not be liable for any consequential loss or compensation nor refund of purchase price nor replacement of the Air Conditioner.
9. Customer must ensure the routine maintenance including cleaning of filter etc. for proper operation.
10. Any change in location/damages on handling will be serviced at extra material and labor cost.
11. While Company would take all necessary steps to repair the Air Conditioner supplied under the warranty and keep sufficient stock of the spare parts of the Air Conditioner with them, however, in certain cases, at the sole discretion of the Company, the Company may due to non-availability of spare parts of the Air Conditioner, resulting into the Air Conditioner not being repaired by the Company, offer a replacement scheme to the purchasers of such Air Conditioner which cannot be repaired due to non-availability of spare parts of the Air Conditioner, purchased under the warranty, the Company would offer a replacement of the Air Conditioner. The details of the replacement offer is subject to change from year to year and shall also be applicable on the MRP of the product to be purchased as a replacement.
12. Two (2) free preventive maintenance service (Labour only) will be provided to the customer during first year warranty period. To avail these free services customer has to register the call at the call center number 1800 209 5511. After expiry of 12 (twelve) months from date of purchase company is not liable for any free service.

Godrej & Boyce Mfg. Co. Ltd.- Appliance Division

CUSTOMER COPY

MODEL NO.

AIR CONDITIONER SERIAL No.:

DATE OF PURCHASE

CUSTOMER'S NAME & ADDRESS

TEL. _____

DEALER'S NAME & ADDRESS

TEL. _____

Customer's Signature:

This warranty is valid only if it is filled in and stamped by our authorized dealer on the date of purchase.

Warranty Voids If:

1. The warranty card is not completed properly at the time of purchase.
2. The completed warranty card is not presented to the authorized personnel at the time of service of the product.
3. The Air Conditioner is not operated and maintained according to instructions given in the 'User Guide'.
4. Defects are caused by improper use, which shall be determined by the company personnel.
5. Unauthorized persons carry out any repair work.
6. Defects are caused by reasons beyond control, like abnormal voltage (exceed 253 V or below 207 V), acts of God, or while in transit to service center or purchaser's residence.
7. The warranty is not valid in case the serial number is deleted, defaced or altered.
8. Damage to the Air Conditioner or any parts due to transportation or shifting is not covered by the warranty.
9. The warranty automatically expires after the stipulated period from the original date of purchase, even if the Air Conditioner may not be in use for any time for whatever reasons.

Service Card

Please fill the warranty card and send it to your nearest branch to avail of 2 free services



		Dry	Dry	Wet	
Bill No.	Date of Sale		Model No.	Sr. No.	
Customer/User's Name			Phone No.		
Address			Sp. instructions, if any		
City	Pin Code				
Dealer/ASP's Name & Address			I confirm that the service has been provided to my satisfaction		
			Customer's Sign & Date		



		Dry	Dry	Wet	
Bill No.	Date of Sale		Model No.	Sr. No.	
Customer/User's Name			Phone No.		
Address			Sp. instructions, if any		
City	Pin Code				
Dealer/ASP's Name & Address			I confirm that the service has been provided to my satisfaction		
			Customer's Sign & Date		



Godrej

Godrej & Boyce Mfg. Co. Ltd. Appliance Division, Plant 11, Pirojshanagar, Vikroli (W), Mumbai 400 079.

Disclaimer-The images shown in the manual are representative. Actual products may vary