

TROPICAL GREEN INVERTER AC

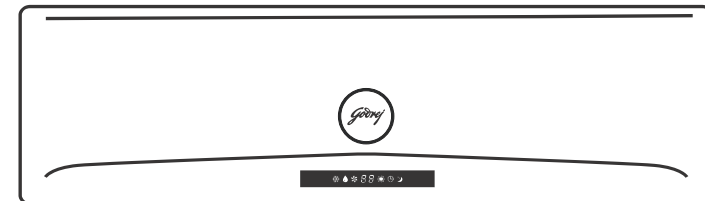

PROUDLY MANUFACTURED IN INDIA AT OUR
GREENCO PLATINUM PLUS CERTIFIED FACTORIES

Split Air Conditioner

Protection of Environment:

"Protection of environment" is one of the core values of Godrej and we seek your co-operation to make sure that this product is not disposed as unsorted municipal waste.



This symbol is known as the "Crossed-out Wheelie Bin Symbol". It means that the product should not be disposed of with your general house-hold waste.

It should be disposed of only through the company's collection centers with special treatment so as to prevent any damage to the environment. Please call: **1800 209 5511** or visit www.godrejappliances.com/green-think for details about Godrej Appliances authorized collection centers.

Dear Customer,

On behalf of Godrej Appliances, we welcome you to the Godrej family, and thank you for giving us an opportunity to serve you.

Godrej Appliances is a leading brand not just in technology and performance but also for its excellent customer service, we have more than 660 service centers across India, so that we can be close to our customers and serve them better.

In order to get maximum out of your superior Air Conditioner, we urge you to go through this detailed user manual. If you need any assistance at any time, do not hesitate to call on 1800 209 5511 or write to us at smartcare@godrej.com

We again thank you for giving us the privilege to serve you, and look forward to a long delightful association.

Warm Regards,
Team Godrej



This symbol stand for the things that should be strictly avoided.



This symbol stand for the things that should be followed.

Thank you for choosing Godrej air conditioner. Please read this owner's manual carefully before operating the unit and keep it carefully for consultation.

The product shown in this manual may be different from the one bought by you.

Please refer to the model bought by you for its looks and the position, shape and size of the displayer.

This appliance is not intended for use by individuals (including children) with reduced physical, sensory or mental capabilities or lack of experience and knowledge, unless they have been given supervision or instruction concerning use of the appliance by a person responsible for their safety.

Children should be supervised to ensure that they do not play with the appliance.

Warranty Air Conditioner

8. Company will not be liable for any consequential loss or refund of purchase price nor replacement of the Air Conditioner.
9. Customer must ensure the routine maintenance including cleaning of filter etc. For proper operation.
10. Any change in location/damages on handling will be extra material and labor cost.
11. While Company would take all necessary steps to repair the Air Conditioner supplied under the warranty and keep sufficient stock of the spare parts of the Air Conditioner with them, however, in certain cases, at the sole discretion of the company, the company may due to non-availability of spare parts of the Air Conditioner, resulting into the Air Conditioner not being repaired by the company, offer a replacement scheme to the purchasers of such Air Conditioner which cannot be repaired due to non-availability of spare parts of Air Conditioner, purchased under the warranty, the company would offer a replacement of the Air Conditioner. The details of the replacement offer is subject to change from year to year and shall also be applicable on the MRP of the product to be purchased as a replacement.
12. Two (2) free preventive maintenance service (labor only) will be provided to the customer during first year warranty period. To avail these free services customer has to register the call at the call center number 1800 209 5511. After expiry of 12 (twelve)month from date of purchase company is not liable for any free service.

Godrej & Boyce Mfg. Co. Ltd.- Appliance Division CUSTOMER COPY

MODEL NO.
AIR CONDITIONER SERIAL No.:

DATE OF PURCHASE:

CUSTOMER'S NAME & ADDRESS

TEL. _____

DEALER'S NAME & ADDRESS

TEL. _____

Customer's Signature:

This warranty is valid only if it is and stamped by our authorized dealer on the date of purchase.

Warranty Voids If:

1. The warranty card is not completed properly at the time of purchase.
2. The completed warranty card is not presented to the authorized personnel at the time of service of the product.
3. The Air Conditioner is not operated and maintained according to instructions given in the 'User Guide'.
4. Defects are caused by improper use, which shall be determined by the company personnel.
5. Unauthorized persons carry out any repair work.
6. Defects are caused by reasons beyond control, like abnormal voltage (exceed 253 V or below 207 V), acts of God, or while in transit to service center or purchase's residence.
7. The warranty is not valid in case the serial number is deleted, defaced or altered.
8. Damage to the Air Conditioner or any parts due to transportation or shifting is not covered by the warranty.
9. The warranty automatically expires after the stipulated period from the original date of purchase, even if the Air Conditioner may not be in use for any time for whatever reasons.

Operational Guideline

If the supply cord is damaged, it must be replaced.

Please contact our company's authorised service provider/dealer



The airflow direction can be adjusted appropriately. When on adjust the vertical airflow direction by adjusting the louvers of upward/downward direction. and then, hold two ends of left and right louver to adjust the horizontal airflow.

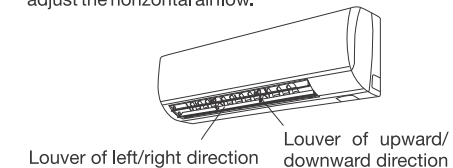

Don't insert your hands or stick into the air intake or outlet vents. Otherwise it will cause accident.

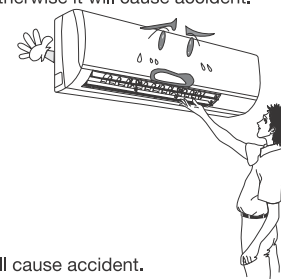

Otherwise it will cause accident.

Don't blow the wind towards animals and plants directly. It can cause a bad influence on them.

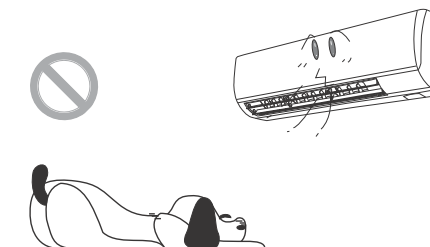

Don't apply the cold wind to the body for a long time directly.



It can cause health problems.

Don't use air conditioner for other purposes, such as drying clothes, preserving food, etc.

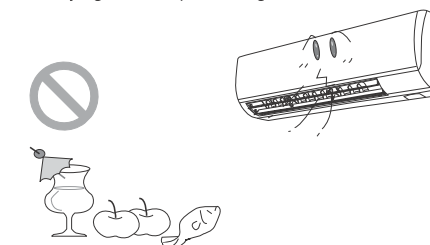

Splashing water on the air conditioner can cause an electric shock and malfunction.



Don't place a heat source near the air conditioner.

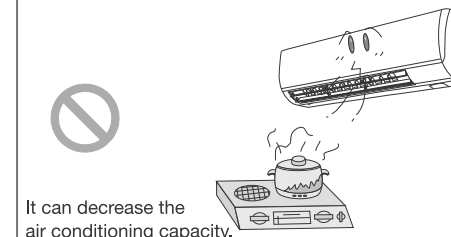

It can decrease the air conditioning capacity.

Operational Guideline

Working principle and special functions for cooling

Principle:

The air conditioner absorbs heat in the room, transmits and discharges it outside resulting in the decrease in ambient temperature. Its cooling capacity will increase depending on the outdoor ambient temperature.

Anti-freezing function:

If the unit is running in COOL mode and in low outdoor ambient temperature, there will be frost formation on the heat exchange. When indoor heat exchange temperature decreases below 0°C, the indoor unit microcomputer will stop the compressor running and protect the unit.

Warranty Air Conditioner

The Godrej Air Conditioner comes with a FIVE year warranty on compressor for fixed speed Air conditioners and TEN year warranty on compressor for Inverter Air Conditioners. Along with this, you also get ONE year warranty on all other parts (except grill and plastic parts) from the date of purchase, against defective material or workmanship. In case of any such defect found during the first year from date of purchase, Godrej and Boyce Mfg. Co. Ltd. - Appliance Division will undertake repairs to the warranted part free of charge, subject to terms and conditions below. In the warranty period beyond the first year from date of purchase, only the compressor will be provided free of cost, when necessary. However, the Air Conditioner will be repaired on payment of necessary charges. The warranty does not cover the demonstration/ installation of the Air Conditioner.

INSTRUCTIONS FOR THE CUSTOMER

1. Kindly ensure that the dealer fills the warranty card correctly and completely.
2. You should retain the warranty card for record and produce the same in the event of any warranty repairs.
3. In the event of a defect developing in the product, contact the nearest authorized Godrej & Boyce Service Center for obtaining warranty service and inform the defect, Model details & Serial No.
4. Product will function between +/-10% of rated volts at 50Hz. For any fluctuation beyond specified limit, company shall not be responsible and warranty stands terminated.
5. In areas where voltage fluctuates below 10% of rated voltage, customer is advised to use a voltage stabilizer which steps up voltage to a minimum of 190V.
6. Earthing provision is necessary for safety. Improper domestic wiring leading to hazards such as shock or fire is not covered under this warranty.
7. The product must be maintained to ensure hygiene. If there are any insects or rodents in it causing obstruction to the functioning of the product, the company shall not be responsible and in-turn warranty stand terminated.

TERMS AND CONDITIONS

1. Repairs and replacement will be carried out by the companies authorized service centers or through authorized dealer's service center.
2. All transportation and handling expenses incurred while repairing will be payable by the customer in advance.
3. For any air conditioner installed beyond the municipal limits of the jurisdiction of the authorized customer service center, charges towards technician's visit will be borne by the customer.
4. While the company will make every effort to carry out the repairs at the earliest, it however is made expressly clear that the company is under no obligation to do so in a specified period of time.
5. The company will retain any part(s), compressor and/ or other components when replaced at its discretion.
6. Warranty does not cover, gas charging to the Air Conditioner.
7. Refrigeration system, gas charging and consumables will be changed for any such repairs after one year from the date of purchase.

GODREJ & BOYCE MFG.CO.LTD.-Appliance Division

For any further assistance, please contact our nearest office or service centre:

Branch	Address	Telephone No.
Ahmedabad	4th Floor, APM Shopping Mall Near IOCL Petrol Pump, Shyamal - Karnavati 100Ft. Road, Satellite, Ahmedabad - 380 015.	Call 1800 - 209 - 5511 (Toll - Free)
Bangalore	3rd Floor, The Karnataka Flim Chamber of commerce Bldg. 28, 1st Main Cresent Road, High Grounds Nr. Shivanand Circle, Bangalore - 560 001.	
Bhopal	217, Zone I, M.P.Nagar, Beh. Jyoti Talkies, Bhopal - 462 011.	
Bhubaneshwar	Highway Complex NH - 5, Ruderapur, Bhubaneshwar - 752 101.	
Chandigarh/Mohali	Plot No. A - 40, Phase - VIII - A, Industrial Area, Mohali - 160059.	
Chennai	No.1 Sidco Industrial Estate. Ambattur, Chennai - 600 098.	
Coimbatore	585 - 590, Sathya Towers 3rd floor, D.B.Road R.S. Puram, Coimbatore - 641 002.	
Delhi	Godrej Bhavan, 2nd Floor, Shershah Suri Marg, Okhla, New Delhi - 110 065.	
Faridabad	Godrej Bhavan, 2nd Floor, Shershah Suri Marg, Okhla, New Delhi - 110 065.	
Ghaziabad	Godrej Bhavan, 2nd Floor, Shershah Suri Marg, Okhla, New Delhi - 110 065.	
Guwahati	Godrej Building, G.S.Road, Ilubai, Flyorer, Guwahati - 781 007.	
Hyderabad	201 & 202, Lala - 1 Land Mark, 5-4-94 to 97, 2nd Floor, Above Digital Shopyy, Ranigunj, M.G.Road, Secundarabad - 500 003.	
Jaipur	502 - 506, 5th Floor, Gaurav Towers, Malviya Nagar, Jaipur - 302 017.	
Kochi	2nd Floor, Angels, Arcade South Kalamassery, Near CUSAT Signal Ernakulam - 682022.	
Kolkata	Block GN, Sector V, Salt lake, Kolkata - 700 091.	
Lucknow	C3/3 & C3/4, Sanjay Complex Behind Akashwani Bhawan, Vidhan Sabha Marg Lucknow - 226001.	
Mumbai	Appliance Divn., Plant 4, Pirojshanagar, Vikhroli, Mumbai - 400079.	
Nagpur	Dr.Bhiwapurkar Chamber 2nd Floor, Opp: Yashwant Stadium Dhantoli, Nagpur - 440012.	
Patna	Jeevna Deep Bldg. Exhibition Road Patna - 800001.	
Pune	Apollo Building Square, Plot No.60, Survey No.599 Sahaney Sujan Park, Lullanagar, Bibewadi Road, Pune - 411 040.	
Raipur	9/1, Besides Bharat Petrol Pump Opp: Hotel Picadelly, Mahoba Bazaar, GE Road, Raipur - 492001.	
Ranchi	C/o. Surya Motors, Near Krishi Bazaar Samiti Pandra, Ranchi(Jharkhand) - 835 222.	

Website: www.godrejappliances.com & www.godrejsmartcare.com
 E-mail: smartcare@godrej.com

Name and function of each part

Indoor unit

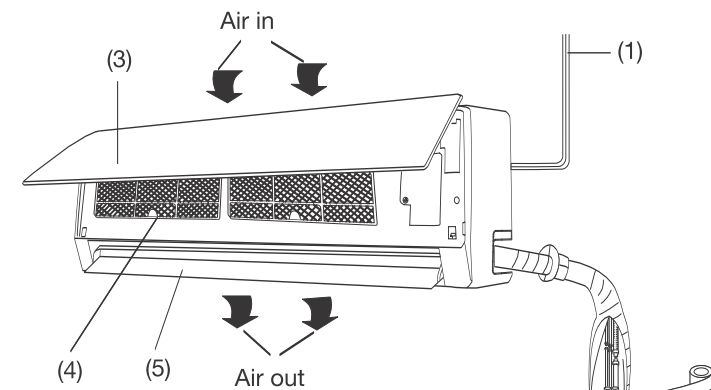

The Icon displayed

- : Run
- : Set temp.

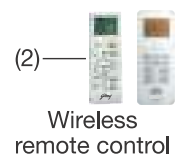

- 1)Power cable
- 2)Remote control
- 3)Front panel
- 4)Filter
- 5)Guide louver
- 6)Connection wire
- 7)Drainage pipe

Outdoor unit

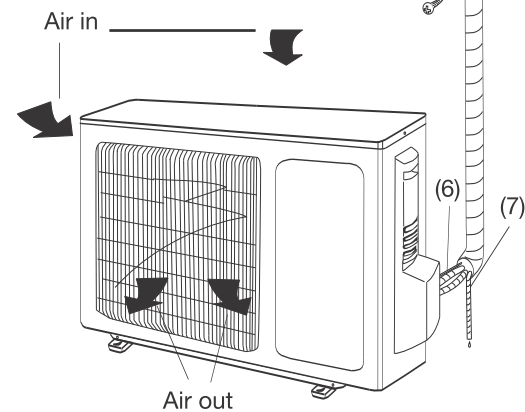

Note: Features and remote buttons may vary with model variant. Please refer to the remote to determine which functional buttons are available in your variant.

Operation of wireless remote control

Name and functions for wireless remote control

Note: Be sure that there are no obstructions between the receiver and the remote hand set; Do not drop or throw the remote hand set; Do not let any liquid in the remote control and do not put the remote control directly under the sunlight or any place which is very hot.

Remote Hand Set



ON/OFF button

Press this button, the unit will be turned on. Press it once more, the unit will turn off. When turning on or turning off the unit, the Timer & Sleep function will be cancelled.

MODE button

Press this button - Auto, Cool, Dry, Fan mode can be selected circularly. Under auto mode, the unit will automatically set 'SET TEMP' at 24°C.



- △ Auto
- ❄ Cool
- 💧 Dry
- 🌀 Fan

NOTE: Please do not select HEAT mode if the machine you purchased is cooling only type. Heat mode is not supported by the cooling only appliance.

SLEEP button

By pressing this button, Sleep On and Sleep off can be selected. By default, the function will be cancelled automatically in Eight hours. After sleep function is set up, the icon for 'Sleep' will be displayed. This function is only available during COOL mode.

When air conditioner is in sleep operation the indoor temp. will increase 1°C in one hour and 1°C more in next three hours.

FAN button

By pressing this button, Low, Middle, High Auto, speed can be circularly selected.

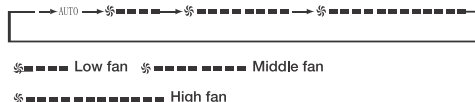

NOTE: Under the Dry mode, the fan speed isn't adjustable, low fan speed is imperative.

LOCK button

When you press the LOCK button (3-5 sec.), all current settings are locked and the icon  will be displayed on it. Remote controller does not accept any operation except that of the LOCK. Press again for 3-5 sec to cancel lock mode. If the keypad is unlocked, the mark will disappear.

DISPLAY button

Press this button to clear the digit display in the air conditioner, press it again to activate it (Not available for the units without LED display window).

When indoor display is ON  will appear on the remote control .

Installation and Maintenance of Health Filter

Installation Instructions

- Pull the front to a specific angle from its two ends according to the arrow direction. Then pull the air filter downwards to remove it. (See Fig. a)
- Mount the health filter onto the air filter, (as shown in fig.b). If the air filter cannot be installed, please mount the health filter on the front case. (as shown in Fig.c)
- Mount the air filter properly along the arrow direction in Fig.d, and then close the panel cover.

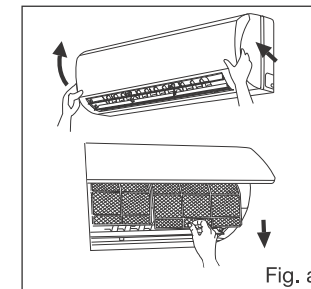

Fig. a

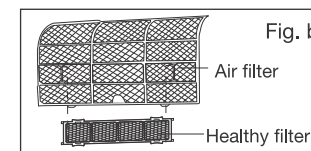

Fig. b

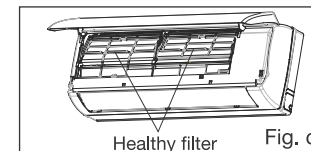

Fig. c

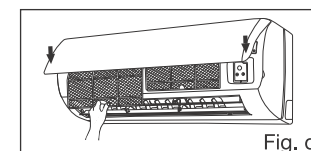

Fig. d

Cleaning and Maintenance

- Take out the healthy filter before cleaning and reinstall it after cleaning according to the installation instruction. Pay special attention that silver ion filter can't be cleaned with water, while active carbon, photo catalyst, low temperature conversion (LTC) catalyst, formaldehyde eliminator, catching or mite killing filter can ,but can't with brush or hard things. Dry it in the shade or sun after cleaning, but not by wiping.

Service Life

The healthy filter commonly has its usage lifetime for one year under normal condition. As for silver ion filter, it is invalid when its surface becomes black(green)

- This supplementary instruction is provided for reference to the unit with health filter. If the graphics provided herein are different from the physical good, the latter one shall prevail. The quantity of healthy filters shall be based on the actual delivery.

Installation of outdoor unit

Electric wiring

- Disassemble the handle on the outdoor unit right side plate.
- Take off cord anchorage. Connect and fix power connect cord to the terminal block.
- Fix the power connection cable with cord anchorage.
- Ensure wire has been fixed well.
- Install the handle.

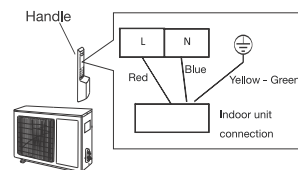

NOTE:

- Wrong wiring may cause spare parts malfunction.
- After the cable fixed, make sure there should be a free space between the connection and fixing place on the lead wire.

Air purging and leakage test

- Connect charging hose of manifold valve to change end of low pressure valve (both high/low pressure valves must be tightly shut).
- Connect joint of changing hose to vacuum pump.
- Fully open handle of Lo manifold pump.
- Open the vacuum pump to evacuate. At the beginning, slightly loosen joint nut of low pressure valve to check if there is air coming inside. (If noise of vacuum pump has been changed, the reading of millimeter is 0) Then tighten the nut.
- Keep evacuating for more than 15 mins and be sure that the reading of the pressure gauge is -1.0 X 105pa (-76cmHg).
- Fully open high/low pressure valves.
- Remove charging hose from charging end of low pressure valve.
- Tighten the nut of low-pressure valve. (As shown in Fig.10)

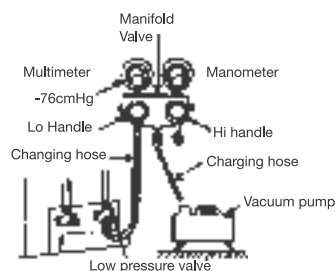

Fig.10

Operation of wireless remote control

Name and function of wireless remote control

Notice: This is a general use remote hand set. It can be used for the air conditioners with multifunction. For some functions which the model doesn't have, pressing the corresponding button on the remote hand set will have no effect on its running status.

Remote Hand Set



growth of bacteria in indoor coil due to moisture is reduced.

TURBO button

Push this button to activate/cancel the Turbo function which enables the unit to reach the preset temperature in the shortest time. On cooling mode, the unit will blow strong cooling air with super high fan speed. By default, this function will cancel in one hour.

TEMP (+) button

For temperature increase:
Press this button, to increase the temperature, when unit is on. In AUTO, DRY and FAN mode temperature cannot be set. Centigrade scale range is from 16°C - 31°C.
This button is also used for setting time during TIMER operation.

TEMP (-) button

For temperature decrease:
Press this button, to decrease the temperature, when unit is on. The temperature adjustment is unavailable in the AUTO, DRY and FAN mode. Centigrade scale range is from 16°C - 31°C.
This button is also used for setting time during TIMER operation.

TEMP button

Press temp key once and room temperature will be displayed on IDU for few seconds

ECO button

Press this button to go into the Energy-Saving operation mode. Press the button again to cancel. By default, the function will be cancelled automatically in eight hours. This function will help to maintain your power consumption.

BLOW button

Press this button, to turn on or turn off the self clean. If a bad odour is coming from the air conditioner, press BLOW button on the remote handset. This function will keep indoor fan at super high fan speed for 5 minutes, after air conditioner is turned OFF. The indication of minutes will display on AC display.

It works in two ways:

- 1) If air conditioner is in operation, and you press BLOW button in COOL and DRY mode, the blower will run at high speed for 5 min. after air conditioner is turned OFF. The decremented time will indicate on display.
- 2) Press BLOW button when air conditioner is OFF, indoor fan will run at high speed for 5 min. and decremented time will indicated on display.

Note: It is recommended to use BLOW function when AC is OFF. This function helps to keep the indoor coil dry and prevent dust and mold accumulation. Also the

Note: Features and remote buttons may vary with model variant. Please refer to the remote to determine which functional buttons are available in your variant.

Operation of wireless remote control

Name and function of wireless remote control

Notice: This is a general use remote hand set. It can be used for the air conditioners with multifunction. For some functions which the model doesn't have, pressing the corresponding button on the remote hand set will have no effect on its running status.

Remote Hand Set



TIMER button

Press this button to initiate auto ON and auto OFF time sequence. Each press will increase the auto timed setting in 30 minutes increments. To set the time use Temp (+) and Temp (-) keys.

- If you pressed TIMER button when AC is ON and set time using remote handset, the AC will turn OFF after set time duration is completed .

- And if you pressed TIMER button when AC is OFF and set time using remote handset, the AC will turn ON after set time duration is completed.



SILENT button

Press this button to lower the acoustic noise of air conditioner. Indoor fan will run at very low speed and make you comfortable. after pressing silent button,  this symbol will be displayed on remote. When you press silent button in cool mode, fan speed will reduce to low speed.

When you press silent button in fan mode, fan speed will reduce to lowest speed. Pressing silent button again, you can cancel silent feature.

SWING UP AND DOWN BUTTON

Press this button, to make IDU swing louver ON and OFF

When IDU swing louver is ON,  will appear on remote control and when Indoor swing is OFF,  will not appear on the remote.

i-Sense button

When you press the I- Sense button, the icon  will be displayed. The featured machine will compare the indoor ambient sensor's temperature to the remote sensor's temperature. In the difference within 5 degrees condition what's compares the ambient sensor's temperature to remote sensor's temperature, remote will send a continuous signal to IDU, means you need to keep the remote IR at the IDU at all times, the machine will exit this mode if IDU did not receive the signal from remote more than 5 mins.

Note: Features and remote buttons may vary with model variant. Please refer to the remote to determine which functional buttons are available in your variant.

Installation of indoor unit

NOTE:

When connecting the electric wire if the wire length is not enough, please contact the authorized service shop and buy an exclusive electric wire that is long enough and has no joints.

- The electric wiring must be correctly connected, wrong connection may cause machine malfunction.
- Tighten the terminal screw in order to prevent loose connection. After tightening the screw, slightly pull the wire and confirm whether it is firm or not.
- If the earthing wire is not connected properly, it may cause electric shock.
- The cover plate must be fixed. Tighten the connection wire, if it is poorly installed, then the dust, moisture may enter in or the connection terminal may get affected by the outside force, and may cause fire or electric shock.

Install the indoor unit

The piping can be led out from the right, right rear, left rear.

- When routing the piping and wiring from the left or right side of indoor unit, it is necessary to cut off the tailings from the chassis(Shown in Fig.7)

1-Cut off the tailings 1 when routing the wiring only;

2-Cut off the tailings 1 and tailing 2 when routing both the wiring and piping.

- Take out the piping from case, wrap the piping electric wire, water tape and pull them through the piping hole(As show in Fig.8)
- Hang the mounting slots of the indoor unit on the upper tabs of the rear panel and check if it is firm enough.(As show in Fig.9)
- The height of the installed location should be 2 m. or more from the floor

Install the connection pipe

- Align the center of the piping flare with the relevant value.
- Screw in the flare nut by hand and then tighten the nut with spanner and torque wrench refer to following:

Hex nut diameter	Tightening torque(N.m)
Φ 6	15~20
Φ 9.52	31~35
Φ 12	50~55
Φ 16	60~65
Φ 19	70~75

NOTE: Firstly connect the connection pipe to indoor unit, then to outdoor unit; pay attention to the piping bending. Don't tighten the joint nut too much, otherwise, it may cause leakage.

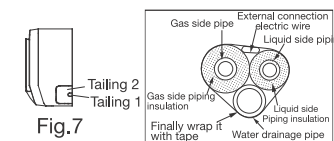

Fig.7

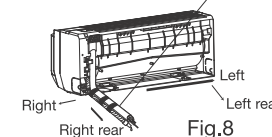

Fig.8

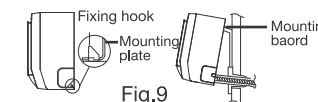
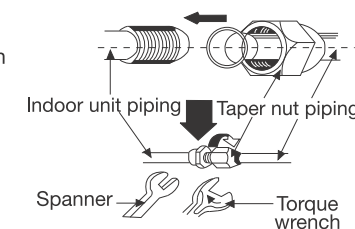

Fig.9



Installation of indoor unit

Install the rear panel

- Always mount the rear panel horizontally. Due to the water tray of indoor unit has been adopted the both-way drainage design, the outlet of water tray should be adjusted slightly down when installing, that is taking the outlet of the water tray as center of a circle, the included angle between the evaporator and level should be 0 or more, that is good for condensing water drainage.
- Fix the rear panel on the wall with screws. (Where is pre-covered with plastic granula)
- Be sure that the rear panel has been fixed firmly enough to withstand the weight of an adult of 60kg, further more, the weight should be evenly shared by each screw.

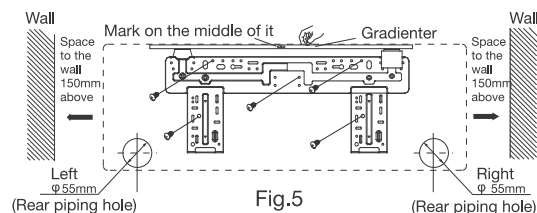

Install the piping hole

- Make the piping hole (55) in the wall at a slight downward slant to the outdoor side.
- Insert the piping hole sleeve into the hole to prevent the connection piping and wiring from being damaged when passing through the hole.

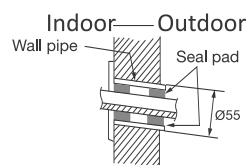

Install the water drainage pipe

- For well draining, the drain hose should be placed at a downward slant.
- Do not wrench or bend the drain hose or flood its end by water.
- When the long drainage hose passing through indoor, should wrap the insulation materials.

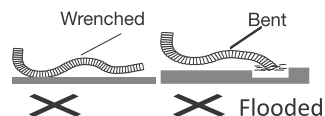

Connect indoor and outdoor electric wires

- Open the surface panel
- Remove the wiring cover Fig.6.
- Connection the inter connection cord to the terminal block, and then fix the cord with cord anchorage.
- Reassemble the clamp and wiring cover.

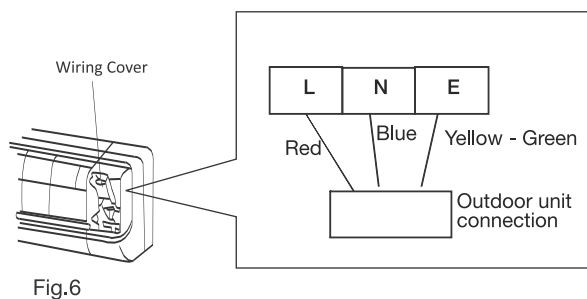

Operation of wireless remote control

Guide for operation - General operation

1. After Switching ON the power supply, press ON/OFF button, and the unit will start to run. (Note: When power is off, the guide louver of the indoor unit will close automatically)
2. Press MODE button to select the desired running mode, or press COOL mode to enter into the corresponding operation directly.
3. Press Temp (+) and Temp (-) button, to set the desired temperature. (Setting temp. function is not available in AUTO, DRY and Fan Mode)
4. Press FAN button to set fan speed and can among low, medium, high and auto.
5. Press Swing (up/down) button, to select the swing.



Guide for operation – Optional operation

1. Press SLEEP button, to set sleep mode.
2. Press TIMER button, to set the scheduled timer ON or timer OFF.
3. Press DISPLAY button, to switch the display on the indoor unit on or off. (This function may be not available for some units)
4. Press TURBO button, to set the TURBO function ON and OFF.



Introduction for special function

About AUTO CLEAN

This function ensures that moisture on evaporator of indoor unit will be blown off after the unit is stopped to avoid mold. This function can be activated using BLOW button on remote control.

About AUTO RUN

When AUTO mode is selected, the set temperature will not be displayed on the remote handset, the unit will monitor the room temp. automatically to select the suitable running method and to make the ambience comfortable.

About TURBO function

When this function is on, the unit will run at super-high fan speed to cool quickly so that the ambient temp. approaches the present temp. as soon as possible.

Following 24 degree logic is applicable when AC is operated in Cool mode :

If user has set the temperature below 24 degree in Cool mode prior to switching off AC and then if AC is turned on by Remote, AC will start operating at 24 degree temperature only.

If user has set the temperature 24 degree or above 24 degree in Cool mode prior to switching off AC and then if AC is turned on by Remote, AC will start operating at previous set temperature by user

Operation of wireless remote control

Guidelines for Changing batteries

Lightly press location marked,  along the arrowhead direction to push the back cover of wireless remote hand set. (As shown in figure)

Take out the batteries. (As shown in figure)

Insert two new AAA1.5V dry batteries and pay attention to the polarity. (As shown in figure)

Replace the back cover of wireless remote hand set. (As shown in figure)

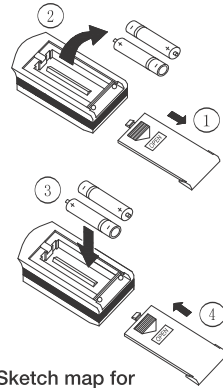

Sketch map for changing batteries

NOTE:

When changing the batteries, do not use the old or different batteries, otherwise, it can cause type malfunction of the wireless remote control.

If the wireless remote control will not be used for a long time, please take them out, and don't let the leakage liquid damage the wireless remote control.

It should be placed at least 1m away from the TV set or stereo sound set. If the wireless remote hand set is not functioning normally, take out the batteries, and after 30s reinsert them. If they are still not running normally replace them.

Dimension diagram for Installation

Installation diagram

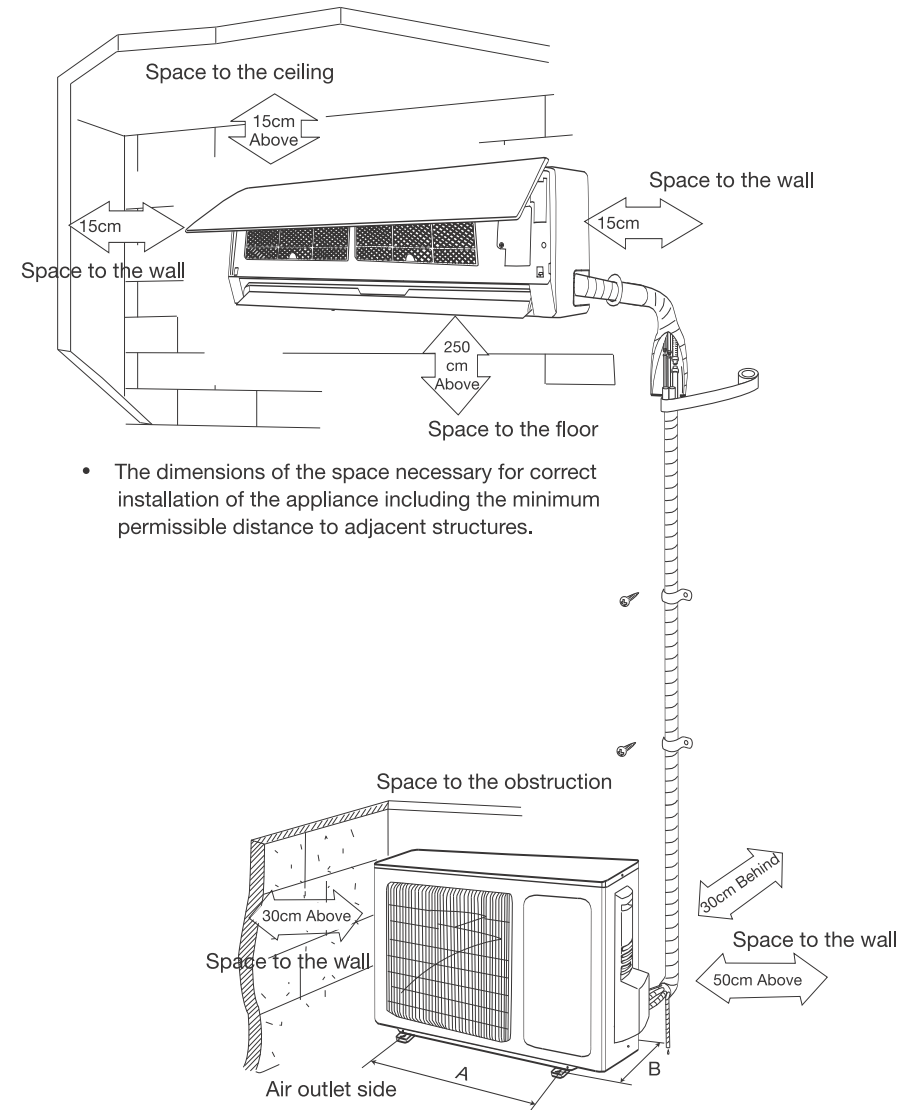

Installation Guideline

Safety Requirements For Electric Appliances

- The power supply should be used as per the rated voltage and AC exclusive circuit, the power cable diameter should be satisfied.
- Don't drag the power cable emphatically.
- It should be reliably earthed, and it should be connected to the special earth device, the installation work should be operated by a company authorised service center. The air switch must have the functions of magnetic tripping and heat tripping, in order to protect the short circuits and overloading.
- The min. distance from the unit and combustive surface is 2m.
- The appliance shall be installed in accordance with national wiring regulation.
- An all-pole disconnection switch having a contact separation of at least 3mm in all poles should be connected in fixed wiring.

Note

- Make sure that the Live wire(RHS) or neutral wire (LHS) as well as the earth wire (top) in the power socket in connected correctly. Power point should be strong enough to withstand the power fed to the air conditioner.
- Wrong connection may cause fire.

Earthing requirements

- Air conditioner is an electric appliance, which needs reliable earthing measure.
- The yellow-green or green wire in air conditioner is earthing wire and cannot be used for other purposes. It cannot be cut off and be fixed by screw, otherwise it world cause electric shock.
- The earth resistance should be according to the National Criterion.
- Please don't connect the earthing wire to any of the following :
 - Tap water pipe
 - Gas pipe
 - Drain pipe.

Know Your Air Conditioner

AUTO Mode:

- Press 'MODE' button to cyclically step through the AUTO → COOL → DRY → FAN modes and stop when AUTO mode is selected.
-  This symbol will appear on the remote display when you select the AUTO mode.
- The air conditioner will automatically select cooling, or fan only operation depending on set temperature and the room temperature.
- Setting temperature cannot be changed . By default it will set to 24° C and display on indoor panel. In this mode the fan speed is changeable (Low ,Medium , High and AUTO)

COOL Mode:

- In the cool mode, the compressor is in operation and your AC functions in the standard operating mode, cooling your room to desired set temperature.
- Press 'MODE' button to cyclically step through the AUTO → COOL → DRY → FAN modes and stop when COOL mode is selected.
-  Symbol can be seen on the remote panel when you select the COOL mode.
- The cooling function allows air conditioner to cool the room and at the same time reduces the humidity in the air. In this mode the compressor will run at different frequencies depending on difference between set temp. and room temp. which gives you faster cooling as compared to fixed speed AC.
- Setting temperature range is 16°C to 31°C.The ideal temperature that can be set for comfort and energy savings is between 21°C to 25°C depending on whether it is day or night.
- You can change the fan speed setting by pressing FAN button.(Low , Medium, High, and AUTO)
- TURBO , SLEEP, and ECO functions are only available during cooling mode.

Dry Mode:

- In the DRY mode, air conditioner reduces the humidity of the air to make the room more comfortable.
- Press 'MODE' button to cyclically step through the AUTO → COOL → DRY → FAN modes and stop when DRY mode is selected.
-  Symbol can be seen on the remote panel when you select the DRY mode.
- The indoor fan runs at low speed and compressor will run at speed as per temperature set to remove extra humidity. In this mode the air conditioner does not blow a lot of cool air, as the intent is just to dry the air and not to cool the room.
- Set temperature and fan speed cannot be changed as indoor fan speed is restricted to Low. Indoor display will show the set temp as 24° C.

Know Your Air Conditioner

Fan Mode:

- Press 'MODE' button to cyclically step through the AUTO→ COOL → DRY → FAN modes and stop when FAN mode is selected.
- ❁ This symbol can be seen on the remote panel when you select the FAN mode.
- In this mode compressor and outdoor fan are OFF and indoor fan speed can be varied between Low, Medium ,High and AUTO speed using remote control.
- Indoor unit displays the indoor room temperature.

Installation Guideline

Important Notices

- The unit installation work must be done by company authorised service provider.
- When removing the unit to the other place, please firstly contact the authorized service center

Basic Requirements For Installation Position

Installation in the following places may cause malfunction. If it is unavoidable contact the authorised service center:

- Place where strong heat sources, vapors, flammable gas or volatile object are emitted.
- Place where high-frequency waves are generated by radio equipment, welders and medical equipment.
- Place where a lot of salinities such as coast exists.
- Place where the oil(machine oil) is contained in the air.
- Place where a sulfur gas is generated such as the hot spring zones.
- Other place with special circumstance.

Indoor Unit Installation Position Selection

- The air inlet and outlet vent should be far from the obstruction, make sure that the air can be blown through the whole room
- Select a location where the condensing water can be easily drained out, and the place is easily connected for outdoor unit.
- Select a location where the children can not reach.
- Select a place which is strong enough to withstand the full weight and vibration of the unit and will not increase the noise
- Be sure to leave enough space to allow access for routine maintenance. The height of the installed location should be 250cm or more from the floor.
- Select a place about 1m or more away from TV set or any other electric appliances.
- Select a place where the filter can be easily taken out.
- Make sure that the indoor unit installation should accord with installation dimension diagram requirements.
- Do not use the unit in the immediate surroundings of a laundry, a bath, a shower or a swimming pool.

Outdoor Unit Installation Position Selection

- Select a location from which noise and outflow air emitted by unit will not cause inconvenience to neighbors, animals, plants.
- Select a location where there is sufficient ventilation.
- Select a location where there should be no obstruction to cover the inlet and outlet vent.
- The location should be able to withstand the full weight and vibration of outdoor unit and permit safe installation.
- Select a dry place, but do not expose under the direct sunlight or strong wind.
- Make sure that the outdoor unit installation dimension should accord with installation dimension diagram, convenient for maintenance, repair.
- The height difference of connecting the tubing should be within 5m, the length of connecting the tubing should be within 10m.
- Select a place where it is out of reach for the children.
- Select a place which will not block the passage and do not influence the city appearance.

Troubleshooting

Phenomenon	Troubleshooting
Noise is heard from the indoor unit	<ul style="list-style-type: none"> ➤ The sound is that of that fan or is caused when the compressor relay is switched on or off. ➤ When the Defrost Function starts and stops functioning sound will be heard. This is due to the refrigerant flowing in reverse direction.
Indoor unit is not blowing air	<ul style="list-style-type: none"> ➤ In dry mode, indoor fan will run at slow speed, in order to avoid condensing water to vaporize again and to restrain temperature rise.
Moisture on air outlet vent.	<ul style="list-style-type: none"> ➤ If unit is running under high humidity for a long time, moisture will condense on the air outlet grill and drip off.



Immediately stop all operations and plug out & contact Company Authorised service center/dealer if -

- There is a hash sound during operation.
- Terrible odors are emitted during operation.
- Water is leaking in the room.
- Air switch or protection switch often breaks.
- Water or something is splashed into the unit.
- The power supply cord and the power plug is abnormally heated up.



Stop running and pull of the plug.

Indication Lamp



This LED illuminates when the air conditioner is in operation.



- Displays the temperature setting when the air conditioner is in operation.

- Displays the malfunction code (Error Code) when fault occurs.

Emergency switch operation

If the wireless remote control is lost or broken, please use the manual switch button. Press the manual switch button once until buzzer sounds once to turn off or turn on the air conditioner. When manual switch is on the unit will run on Auto mode, and the temp can not be changed. The operation is as mentioned below:

Open the panel; the manual switch is on the control box.

- Turn on the unit: When the unit is off, press this button and the unit will run in Auto mode. The microcomputer will measure the indoor temp. and will decide to operate in either cool or fan mode.
- Turn off the unit: When the unit is on, press the button and the unit will stop working.

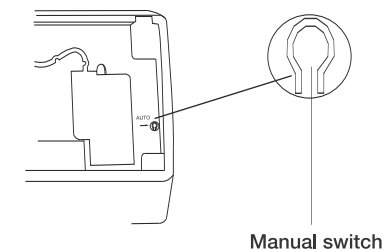

Manual switch

Fig.3

If it happens, it is not a problem

If it happens	It is not a problem
The unit does not operate	Due to high (> 280) or low (< 140) voltage , it has gone into protection mode and thus stopped.
Less cooling	Check whether unit is working in dry mode?
The unit does not respond to commands	Check whether LOCK key is activated or not?
The indoor display is off	Activate DISPLAY key on remote control
If you select 0.5(half hour)timer but IDU display shows 1 (one hour)	Dual digit display limitation. It can't display 0.5, it will display 1 for both Half and one hour.
After AC is switched off, if indoor display shows '05'	It may happen that you have selected the BLOW function when AC was ON , and therefore AC is performing BLOW operation after it turned OFF.
If you set indoor fan speed at low speed, but still it is working at high speed	3 min. delay when fan speed changed from high to low.

Troubleshooting

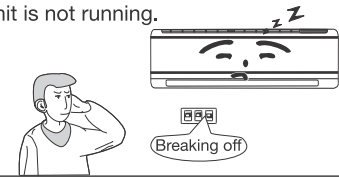
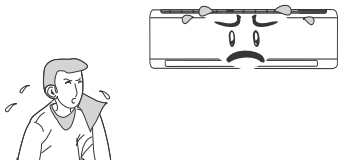
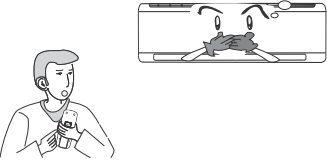



Phenomenon	Troubleshooting
<p>The unit is not running.</p> 	<ul style="list-style-type: none"> ➤ Has the power been shut down? ➤ Is power plug loose? ➤ Has the circuit protection device tripped? ➤ Is voltage high or low? (Tested by professionals) ➤ Is the TIMER correctly used?
<p>Cooling efficiency is not good.</p> 	<ul style="list-style-type: none"> ➤ Is temp setting suitable? ➤ Are inlet and outlet vents obstructed? ➤ Is filter dirty? ➤ Are the windows and doors closed? ➤ Did fan speed set at low speed? ➤ Is there any heat sources in the room?
<p>Wireless remote control is not functioning.</p> 	<ul style="list-style-type: none"> ➤ The unit is disturbed occasionally by abnormal or frequent function switch overs, without the controller's interference. At this time you need to switch off the power, pull off the plug and reinsert it. ➤ Is it in its receiving range? Or is the signal obstructed? Check the batteries of the remote hand set and if required replaced them. ➤ Check whether the wireless remote control is damaged
<p>If there is water leakage in the room.</p>	<ul style="list-style-type: none"> ➤ The humidity in the room is on the high side. ➤ Condensing water over flowed. ➤ The connection point of indoor unit drainage pipe is loose.
<p>If there is water in the outdoor unit.</p>	<ul style="list-style-type: none"> ➤ When the unit is running in COOL mode, the pipe the connection of pipe would be wet due to condensation of moisture in the air. ➤ When the unit is running in Auto Defrosting mode the ice thaws and flows out.

Troubleshooting

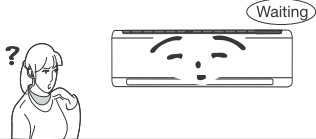

Caution

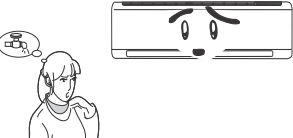

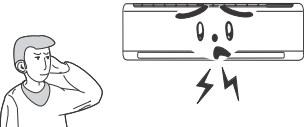

Don't attempt to repair the air conditioner by yourself, it can cause an electric shock or fire. Please check the following items before asking for repair, it can save your time and money.

Phenomenon	Troubleshooting
<p>Not functioning immediately when the air conditioner is restarted.</p> 	<ul style="list-style-type: none"> Once the air conditioner is stopped, it will not operate in approximately 3 minutes to protect itself.
<p>There's unusual smell blowing from the outlet after operation is started.</p> 	<ul style="list-style-type: none"> The unit has no peculiar smell by itself. It can be due to the smell accumulated in the ambient. Solution method: Clean the filter. If problem still exists please contact company authorised service center / dealer.
<p>Sound of water flow can be heard during the operation.</p> 	<ul style="list-style-type: none"> When the air conditioner is switched on or switched off or when the compressor is starts and stops sometimes there is a swoosh or gurgle. This sound is due to the flow of the refrigerant. This is not a malfunction.
<p>In COOL mode, sometimes mist is emitted from the air outlet vent.</p> 	<ul style="list-style-type: none"> When the indoor temperature and humidity are very high, this phenomenon would happen. This is caused by room air swiftly cooling down. After running for a while, decrease and not mist will be emitted.
<p>Creaking noise can be heard from the unit when switching it on or off.</p> 	<ul style="list-style-type: none"> This is caused by the deformation of plastic due to the changes in temperature.

Troubleshooting - Error Codes

ODU Light Flash	IDU Error Code	Abnormality or Protection Description
25	EE	Indoor machine EE fault
26	E1	Indoor fan fault
27	E2	Indoor fan zero - crossing detection abnormal
28	E3	Indoor coil temperature sensor fault
29	E4	Indoor ambient temperature sensor fault
1	E0	Outdoor EE fault
2	E6	Indoor and outdoor machine communication fault
4	F1	Compressor starting abnormal (Phase failure, reverse)
5	F2	Compressor out - of - step fault
6	F3	IPM module fault
8	F5	Discharge temperature sensor fault
10	F7	Outdoor coil temperature sensor fault
11	F8	Outdoor ambient temperature sensor fault
12	F9	Outdoor DC fan fault

WARNING

	The electronic box should not be disassembled, repaired or modified at one's discretion. *There may be the danger of electric shock.
	Watch out for the sharp cooling fin.*You may get hurt by the fins.
	In case of leak test and air purge, be sure to use the vacuum pump or inert gas (nitrogen).The compressed air or combustible gas has the danger of fire and explosion.
	Install outdoor units firmly so that it will not be affected by the earthquake or strong winds . *For safety, do not install outdoor units outside of balconies.
	In case of installing outdoor units beside the road, install the units higher than 2m from the ground or make the heat not reach the pedestrians directly. (According to the construction standards)

Clean and Care



Caution

- Turn power off and pull out the power plug before cleaning air conditioner, or it may cause electric shock.
- Never sprinkle water on the indoor unit or the outdoor unit for cleaning because it can cause an electric shock.
- volatile liquid (e.g. thinner or gasoline) will damage the air conditioner. (So wipe the units with a dry soft cloth, or a cloth slightly moistened with water or cleanser.)
- Air conditioner contains flammable gas.

Cleaning the front panel

When cleaning the front panel, please dip the cloth into water (temperature of below 45°C) squeeze the water out and wipe the dry part.

Note: Please do not immerse the front panel in water, as there are microcomputer components and circuit boards on the front panel which may get damaged.

Cleaning the air filter(Recommended once every three months)

NOTE: If dust around the air conditioner is more, the air filters should be cleaned regularly. After taking off the filter, don't touch the fin of outdoor unit, in order to avoid hurting your fingers.

Take down the air filter

Open the front panel and pull the air filter downwards to take it out. Please see the Fig.4 (a, b)

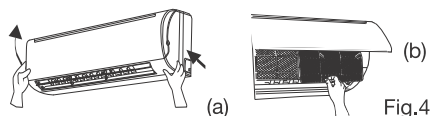

Clean the air filter

To clean the dust on the filters, you can either use a vacuum cleaner, or wash them with warm water and dry it in the shade.

NOTE: Never use water above 45 to clean, or it can cause deformation. Never parch it by fire, or it can cause a fire or deformation.

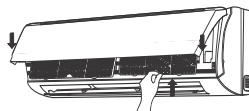
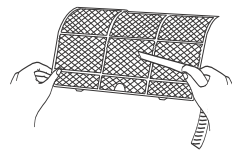

Insert the air filter

Reinsert the filters along the direction of arrowhead, and then cover it with the front panel and clasp it.

Clean and Care

Check before use

- Be sure that nothing obstructs the air outlet and intake vents.
- Check whether ground wire is properly connected or not.
- Check whether the batteries of the air conditioner are functional or not.
- Check whether the installation stand of the outdoor unit is damaged or not. If damaged please contact the company authorised service center/dealer.

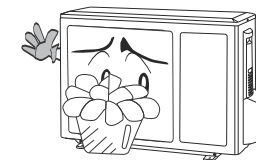

Maintainence during use

- Turn main power off.
- Clean the filter and indoor and outdoor units bodies.
- Clear dust and obstruction from the outdoor unit
- Repaint the rubinginous place on the outdoor unit to prevent it from spreading.
- Adopt the special shield to cover the outdoor unit to avoid the rain water and dust from entering the unit and may cause rust.